



**The Barden Corporation**

A company of the FAG Kugelfischer Group

**FAG**

Innovation in Motion

**PRECISION  
TECHNOLOGY  
INSIDE**



**SUPER PRECISION BEARINGS  
MACHINE TOOL PRODUCTS**



**FAG Aerospace and Super Precision Bearings**

# INTRODUCTION

## A World Leader In Precision Bearing Technology

Welcome to the world of Barden Precision Bearings. For over 100 years Barden/FAG has been a global leader in the development of precision bearing technology. We can satisfy virtually any bearing need, enabling OEM and MRO users to fulfill all their machine tool requirements from a single source.

Barden works with a select network of authorized distributors chosen by their ability to offer quality application engineering advice and product availability. We provide our distributors with training and support to keep them up-to-date on our products and technologies.

### How This Catalog Is Organized

This catalog contains information and product specifications on both Barden and FAG super precision machine tool bearings.

If you have a copy of an earlier Barden catalog, you'll notice this catalog is organized differently: It is divided into two primary sections: 1) Product, and 2) Engineering.

The product sections are organized by type:

- Spindle Bearings
- Floating Displacement Bearings
- Super Precision Cylindrical Roller Bearings
- Double Direction Angular Contact Thrust Ball Bearings
- Ball Screw Support Bearings
- Axial-Radial Cylindrical Roller Bearings

Each bearing type is grouped by bore diameter — from the smallest to the largest. Note that in the product tables both a Barden Basic Bearing Number and an FAG Basic Bearing Number are given. Bearings can be specified using either basic bearing number, depending upon bearing type.

Fold-out pages can be found at the beginning of each of the six product sections. These fold-out pages contain detailed descriptions of bearing nomenclature by product type.

We think these changes improve the usefulness of our machine tool product catalog. Finding the right Barden Precision Bearing for your application is now easier than ever.

We welcome any comments or suggestions you may have regarding our new format. And, as always, thank you for choosing Barden.



*Barden's Super Precision Bearing plant in Danbury, Connecticut.*



*Barden's Super Precision Bearing plant located in Plymouth, Devon, U.K.*



*FAG's Aerospace/Super Precision plant in Schweinfurt, Germany*

**Overview** 4

**Product Tables** 9

**Spindle Bearings**

1800HC/E, 1900HC/E, 100HC/E, 200HC/E, ZSB1900C/E, ZSB100C/E  
B718..C/E, B719..C/E, B70..C/E, B72..C/E, HS719..C/E, HS70..C/E

**Floating Displacement Bearings** 83

FD10

**Super Precision Cylindrical Roller Bearings**

N19, N10, HCN10  
NN30, NNU49

93

**Double Direction Angular Contact**

**Thrust Ball Bearings**

2344, 2347

115

**Ball Screw Support Bearings**

L, BSB, 7602, 7603

129

**Axial-Radial Cylindrical Roller Bearings**

RTC

141

**Engineering**

Life Calculation for Super Precision Bearings •  
Lubrication • Tolerances for Super Precision Bearings •  
Machining Tolerances for Mating Parts • Speed-Dependent  
Fits • Speeds, Deflection and Rigidity • Handling of Super  
Precision Bearings

150

**Index**

200



# THE FINEST BEARINGS THAT CAN BE MADE

## Overview

Barden's focus on super precision bearing technology has long been driven by the needs of our customers for greater accuracy, higher running speeds, longer life and a sensitivity to cost.

As a result, our entire R&D, design and manufacturing philosophy revolves around delivering innovative bearing solutions, better product reliability and lower system costs.

Meeting these stringent demands requires constant interaction with customers to learn more about their

specific application requirements. Our own R&D efforts — along with our support of leading university mechanical engineering and metallurgical research projects — have laid the foundation for the development of new, ever more reliable precision bearing products.

While bearing tolerances are well-defined by DIN/ISO or ABEC standards, Barden super precision bearings routinely exceed even these stringent guidelines, resulting in the production of the finest bearings that can be made.

In addition to meeting — or exceeding — the demanding tolerance requirements of P4/ABEC 9 specifications, there are other Barden-imposed performance features not covered by these standards.

As a result, Barden super precision bearings set standards unchallenged by any other bearing manufacturer in the world today when it comes to performance reliability, greater accuracy, higher running speeds and longer life.

Barden's extensive product line means that whatever your application — from turning machines to textile winders to wood working machines — there's a precision bearing solution that's right for you.

## Barden Super Precision Machine Tool Bearings

Machine tools are the primary application for Barden super precision bearings. However, the wide range of super precision bearing products offered by Barden means that users can satisfy virtually any machine tool application requirement — from spindles to ball screws to turn tables — from a single source. If the machine tool bearing you need is not listed in this catalog, special application specific products can be developed upon request. Ask your Barden representative for more details.



**Barden super precision bearings**

## X-life ultra bearings



### Barden/FAG X-life ultra bearings

X-life ultra bearings are a truly revolutionary new bearing design made from Cronidur 30, a patented high-nitrogen steel originally developed by FAG for critical aerospace applications. X-life ultra bearings offer remarkable performance characteristics, longer life and are 100× more corrosion resistant than conventional stainless steels. X-life ultra spindle bearings — considered the most advanced bearing available on the market today in terms of load capacity and speed — are available for use in a wide range of precision machine tool applications in bore diameters ranging from 20 – 120 mm.

X-life ultra bearings are designed to meet the speed, accuracy and reliability requirements of today's high speed machining centers. X-life ultra bearings can provide substantial savings to both machine tool manufacturers and end users.

X-life ultra bearings allow spindles to run at extremely high speeds under varying lubrication conditions. X-life ultra bearings — when compared to conventional hybrid bearings — will run 30% faster. Also, dynamic load ratings increase by a factor of 2.20 and the permissible contact pressure for infinite fatigue

life rises from 2,000 MPa to 2,500 MPa. Higher admissible contact pressure also allows use of a smaller bearing design which means a lower velocity at unchanged speeds and a corresponding reduction in lubricant stress which results in a significant increase in grease life. This combination of characteristics produces a bearing with a service life up to 10 times longer than today's hybrid bearings! With grease lubrication and attention paid to application parameters, X-life ultra bearings are able to operate at 1.5M dN. Speeds of up to 3.0M dN can be achieved with oil lubrication.

## PRECISION TECHNOLOGY

### Product Features

#### Accuracy to ABEC 9 and Beyond

Barden/FAG super precision angular contact bearings meet — or exceed — ABEC 9 (Precision Class P2) specifications. These standards apply to bearing geometry, overall accuracy and parallelism.

The experience gained with spindle bearings — both in production, and with their practical application in diverse markets — has encouraged the transfer of this technology to other types of bearings. For instance, it also applies to indexing table bearings that meet the demands of a higher precision class bearing.

#### Materials

All Barden super precision bearings are available in either standard or high-grade material versions. For example, greater wear resistance and longer material fatigue life can be achieved by specifying X-life ultra bearings that use Cronidur 30, a unique high nitrogen steel. Its properties — including bending strength and corrosion resistance — result in significantly extended service life, higher admissible contact pressure, higher admissible speeds and significantly enhanced lubricant service life.

Ceramic hybrid bearings — silicon nitride (ceramic) balls and steel inner and outer rings — have proven to be the high performance leader in precision bearing design. Useful life can be extended 2x to 5x over



RTC indexing table bearings



Ceramic hybrid bearings





**Sealed bearings, lubricated for life**



**Barden ultra filtered grease**

conventional steel ball bearing designs. Ceramic hybrids exhibit low vibration levels and can run faster than conventional bearings. The advantages of ceramic balls in hybrid bearings — when compared to conventional steel ball bearings — include:

- reduced material and lubricant stresses due to the excellent tribological behavior of steel and ceramics
- reduced density with correspondingly lower centrifugal forces
- lower thermal expansion coefficient with its positive effect on bearing preload
- higher elastic-modulus that has a positive influence on bearing rigidity.

These factors result in significantly extended bearing life. For this reason, hybrid bearings are commonly used even at lower speeds.

### **Lubrication**

Adequate lubrication is essential to the successful performance of anti-friction bearings. Increased speeds, higher temperatures, improved accuracy and reliability requirements result in the need for closer attention to lubricant selection. Lubricant type and quantity have a marked effect on the functional properties and service life of bearings.

Lubricant type also plays a critical role in deciding which bearing design should be specified for which application. The selection of an oil or grease-lubricated bearing has a potentially enormous impact on overall system operating costs.

Barden super precision bearings — and special Barden high-performance lubricants — permit reliable grease lubrication, even at maximum

speeds. Before a lubricant can be approved for such an application, however, it must undergo a rigorous Barden testing and approval process. Barden G-75, for example, is one such grease. Designed for high speed spindle bearing applications, G-75 combines a fully synthetic base oil with a polyurea thickener instead of a barium complex soap thickener. It offers extremely high thermal stability, exceptional viscosity/temperature behavior characteristics, low base-oil bleed rate and higher service life at high speeds (1.5M dN).

# NOTES

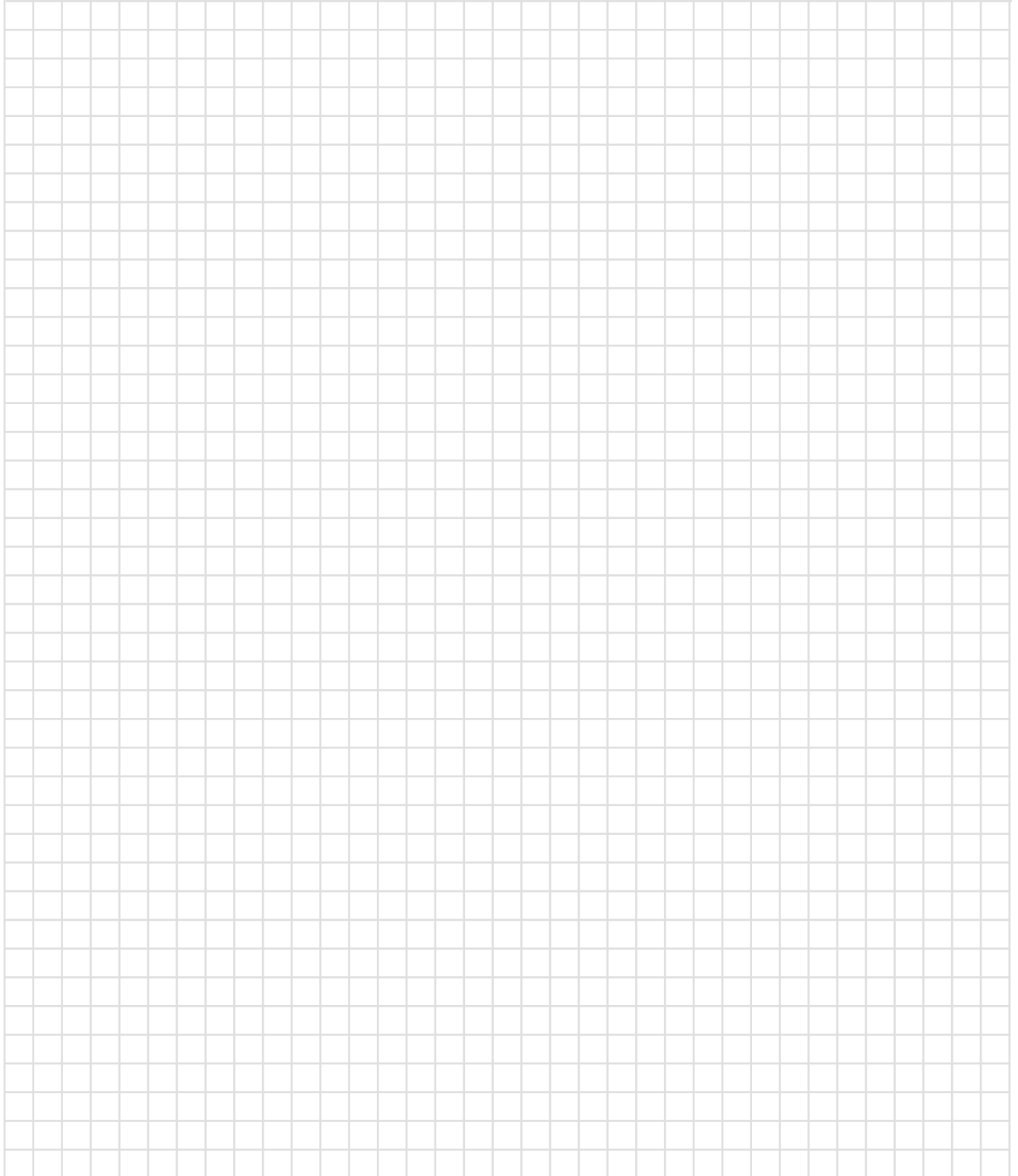



**SPINDLE BEARINGS**



## SPINDLE BEARINGS

Barden spindle bearings are high-precision, single row, angular contact ball bearings. Their special design features — including contact geometry, surface design and other properties — result in a bearing design that offers high precision, excellent speedability, high rigidity and low vibration characteristics.

These bearings are readily available in a wide range of standard sizes, making them suitable replacements for virtually any type of machine tool application.

### “Universal” Bearings

Barden “universal” bearings are manufactured in such a way that they can be mounted in any arrangement or combination of sets — without suffering any loss of bearing performance. This installation flexibility offers several logistical advantages, including the easy interchangeability of bearing stock. The bearings can be arranged according to the symbol on the outer ring surface (Fig. 1).

In universal bearing sets the second letter of the set designation is a U. Bearings of universal sets can be mounted in any arrangement without suffering performance losses. Therefore universal bearing

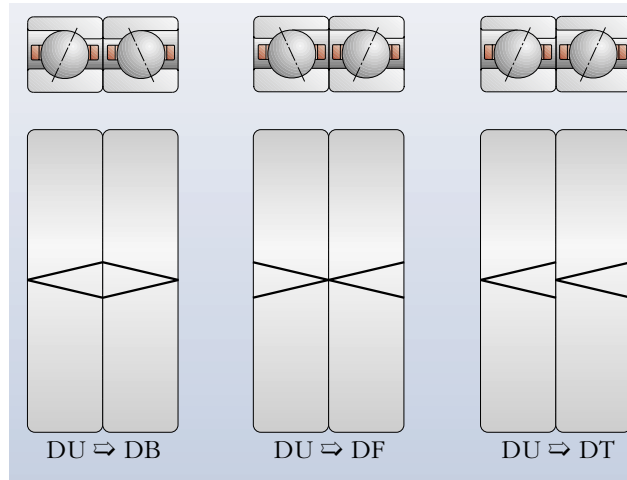
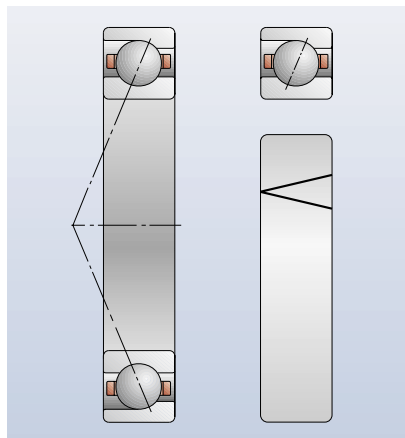

**Fig. 1. Installation possibilities of a DU set**

sets feature no mounting position marks at the circumference except for their contact angle marks.

### Contact Angle Marks on Single Bearings

The position of the contact angle is marked by an arrow on the bearing outer circumference. The open side of the arrow faces the outer ring lip end (Fig. 2).



**Fig. 2. Contact angle marks on a single bearing**

### Spindle Bearing Nomenclature

All Barden and FAG spindle bearings can be identified — and specified — through use of a uniform nomenclature system.

More detailed information on bearing nomenclature can be found in the appropriate nomenclature fold-out pages specific to each product group.

In addition to bearing nomenclature, markings on inner and outer rings provide vital information on:

- bearing width
- the tolerances of the inner ring bore and outside diameter
- the mounting direction, through marking on outer ring surface
- high point of eccentricity of the inner ring.

The FAG nomenclature shown in the product tables is for reference only. All bearings are available exclusively from Barden, and must be ordered using the Barden Basic Bearing Number.

# BARDEN BEARING NOMENCLATURE — SPINDLE BEARINGS

1 08 H C U L  
 1 08 H C RR U L  
 CZSB 1 08 C U L  
 ZSB 1 08 C RR U L

## Bearing Type

- C** Hybrid, standard design,  
Ceramic balls
- XC** X-life ultra  
Ceramic balls
- ZSB** High-speed bearing,  
Steel balls
- CZSB** Hybrid high-speed bearing,  
Ceramic balls
- XCZSB** X-life ultra  
High-speed bearing,  
Ceramic balls

## Dimension Series

- 10MO** Metric 9mm Max Bore
- 1800** Ultra-light series
- 1900** Lightweight series
- 100** Medium series
- 200** Heavy series

## Bore Reference Number

- 6** 6 mm
- 7** 7 mm
- 8** 8 mm
- 9** 9 mm
- 00** 10 mm
- 01** 12 mm
- 02** 15 mm
- 03** 17 mm
- 04** 20 mm
- 04 & up** Multiply last two digits by five to get bore in mm

## Cage

- H** Textile laminated phenolic resin cage  
Outer ring centered

## Contact Angle

- C** 15°
- E** 25°



## Sealing

- RR** Seals at both sides and greased for life

## Preload

- L** Light
- M** Medium
- H** Heavy

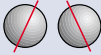
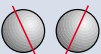
## Bearing Arrangement

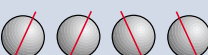
- U** Single bearing  
Any arrangement
- DU** Set of 2 universal bearings
- TU** Set of 3 universal bearings
- QU** Set of 4 universal bearings
- PU** Set of 5 universal bearings
- DB** Set of 2 bearings  
Back-to-back arrangement  

- DF** Set of 2 bearings  
Face-to-face arrangement  

- DT** Set of 2 bearings  
Tandem arrangement  

- TBT** Set of 3 bearings  
Tandem – O – arrangement  

- QBC** Set of 4 bearings  
Tandem – O – Tandem arrangem.  

# FAG BEARING NOMENCLATURE — SPINDLE BEARINGS

HSS 70 08 C .T.P4S.UL  
 HCB 70 08 C DLR.T.P4S.UL  
 B 70 08 C .2RSD.T.P4S.UL  
 B 70 08 C .T.P4S.UL.L75

## Bearing Type

- B** Standard design, Steel balls
- HCB** Hybrid, standard design, Ceramic balls
- XCB** X-life ultra Ceramic balls
- HS** High-speed bearing Steel balls
- HSS** High-speed bearing, Steel balls, sealed
- HC** High-speed bearing, Ceramic balls
- HCS** High-speed bearing, Ceramic balls, sealed
- XC** X-life ultra High-speed bearing, Ceramic balls
- XCS** X-life ultra High-speed bearing, Ceramic balls, sealed

## Dimension Series

- 718** Ultra-light series
- 719** Lightweight series
- 70** Medium series
- 72** Heavy series

## Bore Reference Number

- 6** 6 mm
- 7** 7 mm
- 8** 8 mm
- 9** 9 mm
- 00** 10 mm
- 01** 12 mm
- 02** 15 mm
- 03** 17 mm
- 04** 4 · 5 = 20 mm
- 05** 5 · 5 = 25 mm

## Contact Angle

- C** 15°
- E** 25°

## External Form

- DLR** DIRECT LUBE Direct lubrication via OD, integral O-rings

## Sealing

- .2RSD** Seals at both sides and greased for life

Sealed designs are marked with a point (•) in the bearing tables



## Grease Filling by Manufacturer

- L75** FAG grease Arcanol L75 for non-sealed bearings  
Bearings with seals at both sides are lubricated for life with L75

## Preload

- L** Light
- M** Medium
- H** Heavy

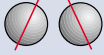
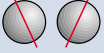
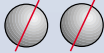
## Bearing Arrangement

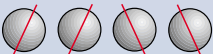
- U** Single bearing  
Any arrangement
- DU** Set of 2 universal bearings
- TU** Set of 3 universal bearings
- QU** Set of 4 universal bearings
- PU** Set of 5 universal bearings
- DB** Set of 2 bearings  
Back-to-back arrangement  

- DF** Set of 2 bearings  
Face-to-face arrangement  

- DT** Set of 2 bearings  
Tandem arrangement  

- TBT** Set of 3 bearings  
Tandem – O – arrangement  

- QBC** Set of 4 bearings  
Tandem – O – Tandem arrangement  

## Accuracy

- P4S** FAG standard (ABEC 7 nominal tolerances, ABEC 9 running accuracies)

## Cage

- T** Textile laminated phenolic resin cage  
Outer ring centered
- TPA** Textile laminated phenolic resin cage  
Outer ring centered, Series B718



# SPINDLE BEARING INSTALLATION NOTES

## Designation and Marking of Bearing Sets

Bearing sets consist of bearings with matched bore and outside diameters. The first letter refers to the number of bearings in a set.

- D .....2 bearings Duplex
- T .....3 bearings Triplex
- Q .....4 bearings Quadruplex

Ready-to-mount bearing sets feature a defined order of bearings. The second and third letters refer to the preloading of the bearings within the set:

- B .....back-to-back arrangement
- F .....face-to-face arrangement
- T .....tandem arrangement
- BT .....back-to-back arrangement against a tandem set of 2 or 3 bearings
- FT .....face-to-face arrangement against a tandem set of 2 or 3 bearings

In ready-to-mount bearing sets the overall large arrow indicates the position of the bearing within the set. The load direction (contact angle position) is indicated through the small arrow symbol at the circumference of the single bearing.

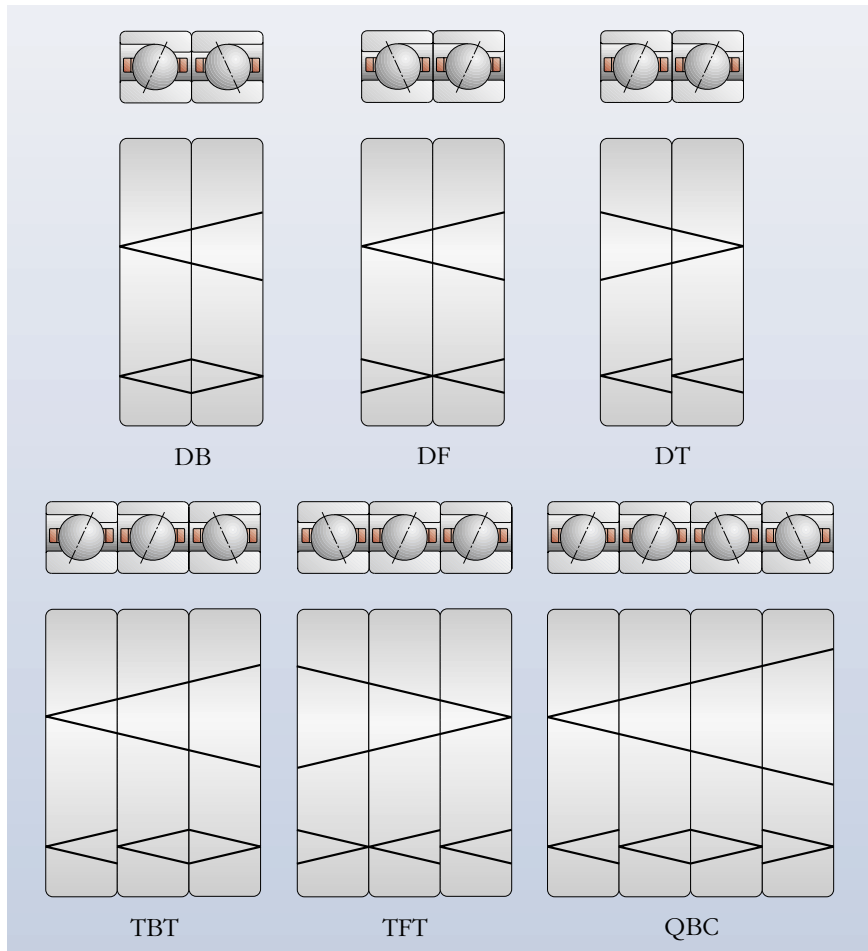

**Examples of ready-to-mount bearing sets**

## SPINDLE BEARINGS

### X-life Ultra Bearings

X-life ultra bearings were designed to achieve maximum speeds, loads and long life. They are hybrid bearings combining rings made of Cronidur 30, a high nitrogen stainless steel and ceramic (Silicon Nitride) balls. Compared to conventional bearing steels, Cronidur 30 exhibits a substantially finer grain structure, thus ensuring cooler operation and higher admissible contact pressure. Most bearing designs are available as X-life ultra bearings. The extended service life of X-life ultra bearings — 10× that of conventional bearings — can help reduce system costs. Additional long life benefits can be obtained through the use of non-contacting “seals.”



**X-life ultra bearings**

### Ceramic Hybrid Bearings

Hybrid bearings — steel rings and ceramic balls — are now a popular choice for many spindle bearing applications. Originally developed for use at high speeds, hybrid bearings are now being specified for lower speed applications because of their proven quality/performance reliability and long service life. Use of grease lubricated bearings can further increase useful life and reduce system costs.



**Silicone nitride (ceramic) balls are used in all Barden hybrid bearing designs**



## Direct Lube (DLR) Bearings

Where grease lubrication can't be used, direct lube bearings may be the solution. Direct lube bearings ensure reliable lubricant feed very close to the point of contact. This is achieved by a circumferential groove and radial supply holes. Integral precision O-rings seal the bearing against the spindle housing. Because of this special design, high performance is coupled with a reduction of the overall bearing system cost.



**Direct Lube (DLR) Bearing**

## Sealed Spindle Bearings

Sealed spindle bearings allow the use of a more economical grease lubrication system. These bearings are factory-filled with Barden's high-performance G-75 grease, then fitted with non-contact seals on both sides.

The advantages of sealed spindle bearings are:

- Non-contacting seal design
- Greased for life lubrication
- Box-to-spindle (ready for assembly)
- Interchangeable with standard spindle bearings
- Proper grease quantity
- Controlled greasing process
- Elimination of contamination during handling
- Enhanced performance due to added sealing and grease near contact zone



**Sealed spindle bearings**

# SPINDLE BEARINGS

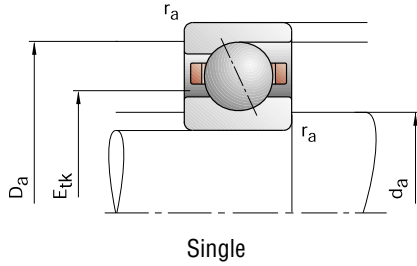

Single

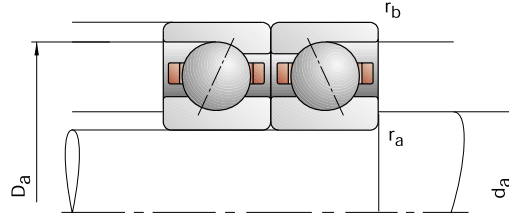

Duplex

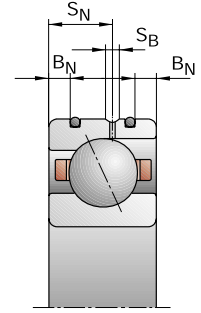

Direct Lube (DLR)

Barden Basic Bearing Number	Dimensions					Shaft & Shoulder Housing Dimensions				DLR Dimensions				Load Ratings	
	d	D	B	r <sub>smin</sub>	r <sub>1smin</sub>	d <sub>a</sub> h12	D <sub>a</sub> H12	r <sub>a</sub> max	r <sub>b</sub> max	B <sub>N</sub>	S <sub>N</sub>	S <sub>B</sub>	E <sub>tk</sub>	C <sub>dyn</sub>	C <sub>0stat</sub>
mm															
10M6HC	6	17	6	0.30	0.30	8.5	14.5	0.3	0.1				10.5	2.36	0.97
10M6HE	6	17	6	0.30	0.30	8.5	14.5	0.3	0.1				10.5	2.28	0.93
C10M6HC	6	17	6	0.30	0.30	8.5	14.5	0.3	0.1				10.5	1.63	0.67
C10M6HE	6	17	6	0.30	0.30	8.5	14.5	0.3	0.1				10.5	1.56	0.66
XC10M6HC	6	17	6	0.30	0.30	8.5	14.5	0.3	0.1				10.5	3.65	0.67
XC10M6HE	6	17	6	0.30	0.30	8.5	14.5	0.3	0.1				10.5	3.45	0.66
ZSB10M6C	6	17	6	0.30	0.30	8.5	14.5	0.3	0.1				10.5	1.56	0.70
ZSB10M6E	6	17	6	0.30	0.30	8.5	14.5	0.3	0.1				10.5	1.50	0.66
CZSB10M6C	6	17	6	0.30	0.30	8.5	14.5	0.3	0.1				10.5	1.08	0.48
CZSB10M6E	6	17	6	0.30	0.30	8.5	14.5	0.3	0.1				10.5	1.04	0.46
XCZSB10M6C	6	17	6	0.30	0.30	8.5	14.5	0.3	0.1				10.5	2.40	0.48
XCZSB10M6E	6	17	6	0.30	0.30	8.5	14.5	0.3	0.1				10.5	2.32	0.46
10M7HC	7	19	6	0.30	0.30	10	16	0.3	0.1				12.0	2.60	1.14
10M7HE	7	19	6	0.30	0.30	10	16	0.3	0.1				12.0	2.50	1.10
C10M7HC	7	19	6	0.30	0.30	10	16	0.3	0.1				12.0	1.80	0.80
C10M7HE	7	19	6	0.30	0.30	10	16	0.3	0.1				12.0	1.73	0.77
XC10M7HC	7	19	6	0.30	0.30	10	16	0.3	0.1				12.0	4.05	0.80
XC10M7HE	7	19	6	0.30	0.30	10	16	0.3	0.1				12.0	3.90	0.77
ZSB10M7C	7	19	6	0.30	0.30	10	16	0.3	0.1				12.0	1.70	0.80
ZSB10M7E	7	19	6	0.30	0.30	10	16	0.3	0.1				12.0	1.60	0.77
CZSB10M7C	7	19	6	0.30	0.30	10	16	0.3	0.1				12.0	1.16	0.55
CZSB10M7E	7	19	6	0.30	0.30	10	16	0.3	0.1				12.0	1.10	0.53
XCZSB10M7C	7	19	6	0.30	0.30	10	16	0.3	0.1				12.0	2.60	0.55
XCZSB10M7E	7	19	6	0.30	0.30	10	16	0.3	0.1				12.0	2.45	0.53

**Designation examples:**

Barden  
FAG

**Sealed design**

ZSB10M6ERRUL  
(HSS706E.T.P4S.UL)

**Hybrid ceramic design**

C10M6HCUL  
(HCB706C.T.P4S.UL)



# SPINDLE BEARINGS

## 10M...HC/E, ZSB10M...C/E

C: Contact Angle  $\alpha = 15^\circ$  / E: Contact Angle  $\alpha = 25^\circ$

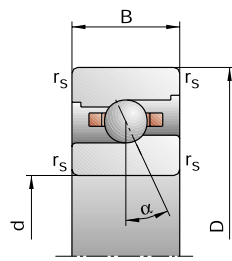

High Speed Design (ZSB)

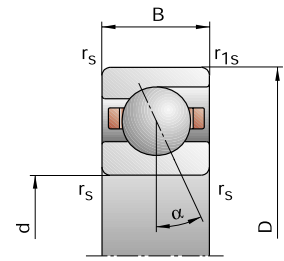

Standard Design

Attainable Speed*		Standard Preload $F_V$ (Force)			Unloading Force $K_{aE}$			Axial Rigidity $S_a$			Sealed Design	Weight	FAG Basic Bearing Number†
Grease	Oil minimal	L	M	H	L	M	H	L	M	H		kg	
min <sup>-1</sup>		N						N/μm					
95000	160000	9	34	77	28	119	294	8.6	16.4	25.5	–	0.005	B706C.T.P4S
85000	140000	14	60	132	42	187	429	20.9	36.5	51.4	–	0.005	B706E.T.P4S
120000	190000	5	17	39	15	56	138	7.5	13.0	19.5	–	0.004	HCB706C.T.P4S
100000	170000	5	28	67	15	85	211	16.5	30.3	43.0	–	0.004	HCB706E.T.P4S
160000	260000	5	17	39	15	56	138	7.5	13.0	19.5	–	0.004	XCB706C.T.P4S
130000	200000	5	28	67	15	85	211	16.5	30.3	43.0	–	0.004	XCB706E.T.P4S
120000	190000	5	16	31	15	52	108	6.2	10.5	14.7	•	0.010	HS706C.T.P4S
100000	170000	8	25	51	23	75	157	15.3	23.8	31.6	•	0.010	HS706E.T.P4S
140000	220000	4	11	21	12	35	70	6.4	9.9	13.3	•	0.010	HC706C.T.P4S
120000	190000	6	18	35	18	54	107	16.2	23.7	30.6	•	0.010	HC706E.T.P4S
180000	300000	4	11	21	12	35	70	6.4	9.9	13.3	•	0.010	XC706C.T.P4S
160000	260000	6	18	35	18	54	107	16.2	23.7	30.6	•	0.010	XC706E.T.P4S
85000	140000	9	38	85	28	133	324	9.3	18.4	28.4	–	0.008	B707C.T.P4S
75000	120000	16	65	145	47	202	470	23.2	40.4	57.1	–	0.008	B707E.T.P4S
110000	180000	5	18	43	15	59	152	8.1	14.2	21.7	–	0.007	HCB707C.T.P4S
95000	160000	5	30	73	15	91	228	17.8	33.5	47.5	–	0.007	HCB707E.T.P4S
150000	240000	5	18	43	15	59	152	8.1	14.2	21.7	–	0.007	XCB707C.T.P4S
120000	190000	5	30	73	15	91	228	17.8	33.5	47.5	–	0.007	XCB707E.T.P4S
110000	180000	6	17	34	18	55	118	7.1	11.4	16.2	•	0.010	HS707C.T.P4S
90000	150000	9	27	54	26	81	166	17.2	26.1	34.4	•	0.010	HS707E.T.P4S
120000	190000	4	12	23	12	38	77	6.9	10.9	14.8	•	0.010	HC707C.T.P4S
110000	180000	6	19	37	18	57	112	17.4	25.9	33.1	•	0.010	HC707E.T.P4S
160000	260000	4	12	23	12	38	77	6.9	10.9	14.8	•	0.010	XC707C.T.P4S
140000	220000	6	19	37	18	57	112	17.4	25.9	33.1	•	0.010	XC707E.T.P4S

### X-life ultra design

**XC10M6HEUL**  
(XCB706E.T.P4S.UL)

† FAG Basic Bearing Number is for reference only. All bearings are available exclusively from Barden, and must be ordered using the Barden Basic Bearing Number.

\* = speeds indicated are for spring preloads.



# SPINDLE BEARINGS

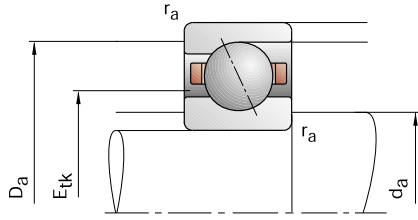

Single

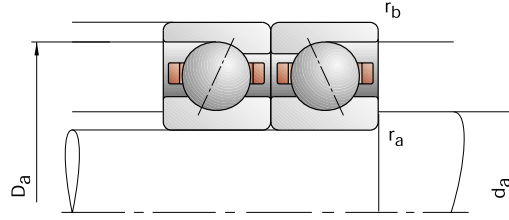

Duplex

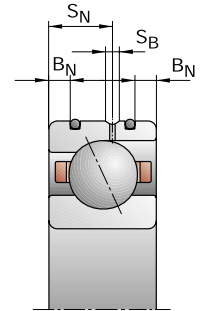

Direct Lube (DLR)

Barden Basic Bearing Number	Dimensions					Shaft & Shoulder Housing Dimensions				DLR Dimensions				Load Ratings	
	d	D	B	r <sub>smin</sub>	r <sub>1smin</sub>	d <sub>a</sub> h12	D <sub>a</sub> H12	r <sub>a</sub> max	r <sub>b</sub> max	B <sub>N</sub>	S <sub>N</sub>	S <sub>B</sub>	E <sub>tk</sub>	C <sub>dyn</sub>	C <sub>0stat</sub>
mm															
10M8HC	8	22	7	0.30	0.30	11	19	0.3	0.1				14.0	3.80	1.73
10M8HE	8	22	7	0.30	0.30	11	19	0.3	0.1				14.0	3.75	1.66
C10M8HC	8	22	7	0.30	0.30	11	19	0.3	0.1				14.0	2.65	1.20
C10M8HE	8	22	7	0.30	0.30	11	19	0.3	0.1				14.0	2.55	1.16
XC10M8HC	8	22	7	0.30	0.30	11	19	0.3	0.1				14.0	6.00	1.20
XC10M8HE	8	22	7	0.30	0.30	11	19	0.3	0.1				14.0	5.70	1.16
ZSB10M8C	8	22	7	0.30	0.30	11	19	0.3	0.1				14.0	1.90	1.00
ZSB10M8E	8	22	7	0.30	0.30	11	19	0.3	0.1				14.0	1.80	0.95
CZSB10M8C	8	22	7	0.30	0.30	11	19	0.3	0.1				14.0	1.29	0.70
CZSB10M8E	8	22	7	0.30	0.30	11	19	0.3	0.1				14.0	1.22	0.66
XCZSB10M8C	8	22	7	0.30	0.30	11	19	0.3	0.1				14.0	2.90	0.70
XCZSB10M8E	8	22	7	0.30	0.30	11	19	0.3	0.1				14.0	2.70	0.66
10M9HC	9	24	7	0.30	0.30	12	21	0.3	0.1				15.3	5.20	2.40
10M9HE	9	24	7	0.30	0.30	12	21	0.3	0.1				15.3	5.10	2.32
C10M9HC	9	24	7	0.30	0.30	12	21	0.3	0.1				15.3	3.60	1.66
C10M9HE	9	24	7	0.30	0.30	12	21	0.3	0.1				15.3	3.45	1.60
XC10M9HC	9	24	7	0.30	0.30	12	21	0.3	0.1				15.3	8.00	1.66
XC10M9HE	9	24	7	0.30	0.30	12	21	0.3	0.1				15.3	7.65	1.60
ZSB10M9C	9	24	7	0.30	0.30	12	21	0.3	0.1				15.3	2.65	1.43
ZSB10M9E	9	24	7	0.30	0.30	12	21	0.3	0.1				15.3	2.50	1.37
CZSB10M9C	9	24	7	0.30	0.30	12	21	0.3	0.1				15.3	1.83	1.00
CZSB10M9E	9	24	7	0.30	0.30	12	21	0.3	0.1				15.3	1.73	0.95
XCZSB10M9C	9	24	7	0.30	0.30	12	21	0.3	0.1				15.3	4.05	1.00
XCZSB10M9E	9	24	7	0.30	0.30	12	21	0.3	0.1				15.3	3.90	0.95

**Designation examples:**

Barden  
FAG

**Sealed design**

ZSB10M8HERRUL  
(HSS708E.T.P4S.UL)

**Hybrid ceramic design**

C10M8HCUL  
(HCB708C.T.P4S.UL)

# SPINDLE BEARINGS

## 10M...HC/E, ZSB10M...C/E

C: Contact Angle  $\alpha = 15^\circ$  / E: Contact Angle  $\alpha = 25^\circ$

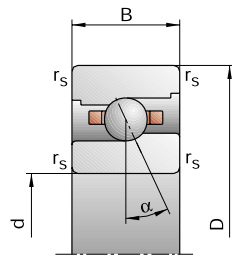

High Speed Design (ZSB)

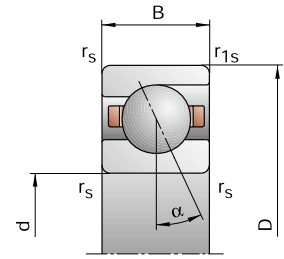

Standard Design

Attainable Speed*	Grease	Oil minimal	Standard Preload $F_V$ (Force)			Unloading Force $K_{aE}$			Axial Rigidity $S_a$			Sealed Design	Weight	FAG Basic Bearing Number†
			L	M	H	L	M	H	L	M	H			
min <sup>-1</sup>			N						N/μm				kg	
75000	120000	15	59	129	47	206	490	12.0	22.9	34.9	–	0.010	B708C.T.P4S	
67000	100000	19	90	207	56	277	668	26.4	47.9	68.6	–	0.010	B708E.T.P4S	
95000	160000	6	29	66	18	95	232	9.2	18.0	26.8	–	0.009	HCB708C.T.P4S	
80000	130000	10	39	100	29	118	312	23.4	39.1	56.5	–	0.009	HCB708E.T.P4S	
120000	190000	6	29	66	18	95	232	9.2	18.0	26.8	–	0.009	XCB708C.T.P4S	
100000	170000	10	39	100	29	118	312	23.4	39.1	56.5	–	0.009	XCB708E.T.P4S	
95000	160000	6	19	38	18	62	131	8.0	13.4	18.7	•	0.010	HS708C.T.P4S	
80000	130000	10	30	61	29	89	187	20.1	30.2	40.3	•	0.010	HS708E.T.P4S	
110000	180000	4	13	26	12	41	87	7.7	12.5	17.3	•	0.010	HC708C.T.P4S	
90000	150000	7	21	42	20	62	127	19.7	29.7	38.9	•	0.010	HC708E.T.P4S	
140000	220000	4	13	26	12	41	87	7.7	12.5	17.3	•	0.010	XC708C.T.P4S	
120000	190000	7	21	42	20	62	127	19.7	29.7	38.9	•	0.010	XC708E.T.P4S	
67000	100000	23	85	181	72	293	676	14.4	26.5	39.6	–	0.015	B709C.T.P4S	
60000	90000	31	131	292	91	401	930	32.4	56.3	79.0	–	0.015	B709E.T.P4S	
85000	140000	8	39	90	24	127	311	10.6	20.5	30.2	–	0.013	HCB709C.T.P4S	
75000	120000	15	56	137	44	168	423	28.3	45.7	64.6	–	0.013	HCB709E.T.P4S	
110000	180000	8	39	90	24	127	311	10.6	20.5	30.2	–	0.013	XCB709C.T.P4S	
100000	170000	15	56	137	44	168	423	28.3	45.7	64.6	–	0.013	XCB709E.T.P4S	
85000	140000	9	26	53	27	84	181	10.2	16.3	22.9	•	0.020	HS709C.T.P4S	
75000	120000	14	43	86	41	128	262	25.2	37.9	49.8	•	0.020	HS709E.T.P4S	
100000	170000	6	18	36	18	57	119	9.8	15.5	21.1	•	0.020	HC709C.T.P4S	
85000	140000	10	30	59	29	89	179	25.0	37.3	48.5	•	0.020	HC709E.T.P4S	
130000	200000	6	18	36	18	57	119	9.8	15.5	21.1	•	0.020	XC709C.T.P4S	
110000	180000	10	30	59	29	89	179	25.0	37.3	48.5	•	0.020	XC709E.T.P4S	

### X-life ultra design

**XC10M8HEDUL**  
(**XCB708E.T.P4S.DUL**)

† FAG Basic Bearing Number is for reference only. All bearings are available exclusively from Barden, and must be ordered using the Barden Basic Bearing Number.

\* = speeds indicated are for spring preloads.



# SPINDLE BEARINGS

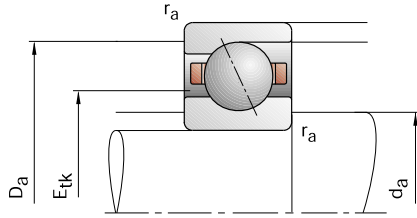

Single

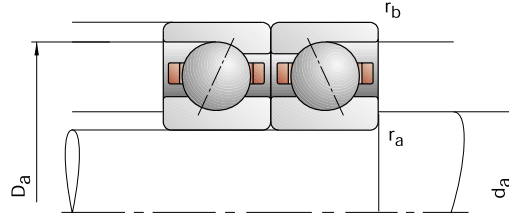

Duplex

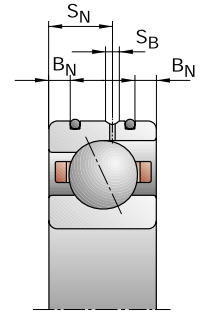

Direct Lube (DLR)

Barden Basic Bearing Number	Dimensions					Shaft & Shoulder Housing Dimensions				DLR Dimensions				Load Ratings	
	d	D	B	r <sub>smin</sub>	r <sub>1smin</sub>	d <sub>a</sub> h12	D <sub>a</sub> H12	r <sub>a</sub> max	r <sub>b</sub> max	B <sub>N</sub>	S <sub>N</sub>	S <sub>B</sub>	E <sub>tk</sub>	C <sub>dyn</sub>	C <sub>0stat</sub>
mm															
1800HC	10	19	5	0.30	0.10	12	17	0.3	0.1				13.3	1.90	0.98
1800HE	10	19	5	0.30	0.10	12	17	0.3	0.1				13.3	1.80	0.93
C1800HC	10	19	5	0.30	0.10	12	17	0.3	0.1				13.3	1.29	0.98
C1800HE	10	19	5	0.30	0.10	12	17	0.3	0.1				13.3	1.25	0.65
1900HC	10	22	6	0.30	0.30	13	19.5	0.3	0.3				15.2	3.00	1.53
1900HE	10	22	6	0.30	0.30	13	19.5	0.3	0.3				15.2	2.90	1.46
C1900HC	10	22	6	0.30	0.30	13	19.5	0.3	0.3				15.2	2.08	1.06
C1900HE	10	22	6	0.30	0.30	13	19.5	0.3	0.3				15.2	2.00	1.00
XC1900HC	10	22	6	0.30	0.30	13	19.5	0.3	0.3				15.2	4.65	1.06
XC1900HE	10	22	6	0.30	0.30	13	19.5	0.3	0.3				15.2	4.50	1.00
ZSB1900C	10	22	6	0.30	0.30	13	19.5	0.3	0.3				15.0	1.96	1.10
ZSB1900E	10	22	6	0.30	0.30	13	19.5	0.3	0.3				15.0	1.86	1.04
CZSB1900C	10	22	6	0.30	0.30	13	19.5	0.3	0.3				15.0	1.37	0.77
CZSB1900E	10	22	6	0.30	0.30	13	19.5	0.3	0.3				15.0	1.29	0.72
XCZSB1900C	10	22	6	0.30	0.30	13	19.5	0.3	0.3				15.0	3.05	0.77
XCZSB1900E	10	22	6	0.30	0.30	13	19.5	0.3	0.3				15.0	2.90	0.72
100HC	10	26	8	0.30	0.30	14	22	0.3	0.1				16.4	4.25	2.08
100HE	10	26	8	0.30	0.30	14	22	0.3	0.1				16.4	4.05	2.00
C100HC	10	26	8	0.30	0.30	14	22	0.3	0.1				16.4	2.90	1.43
C100HE	10	26	8	0.30	0.30	14	22	0.3	0.1				16.4	2.80	1.40
XC100HC	10	26	8	0.30	0.30	14	22	0.3	0.1				16.4	6.40	1.43
XC100HE	10	26	8	0.30	0.30	14	22	0.3	0.1				16.4	6.30	1.40
ZSB100C	10	26	8	0.30	0.30	14	22	0.3	0.1				16.8	2.75	1.60
ZSB100E	10	26	8	0.30	0.30	14	22	0.3	0.1				16.8	2.60	1.50
CZSB100C	10	26	8	0.30	0.30	14	22	0.3	0.1				16.8	1.90	1.10
CZSB100E	10	26	8	0.30	0.30	14	22	0.3	0.1				16.8	1.80	1.06
XCZSB100C	10	26	8	0.30	0.30	14	22	0.3	0.1				16.8	4.30	1.10
XCZSB100E	10	26	8	0.30	0.30	14	22	0.3	0.1				16.8	4.00	1.06
200HC	10	30	9	0.60	0.60	14.5	25.5	0.6	0.6				18.8	5.85	2.90
200HE	10	30	9	0.60	0.60	14.5	25.5	0.6	0.6				18.8	5.60	2.80
C200HC	10	30	9	0.60	0.60	14.5	25.5	0.6	0.6				18.8	4.00	2.04
C200HE	10	30	9	0.60	0.60	14.5	25.5	0.6	0.6				18.8	3.90	1.96

**Designation examples:**

Barden

FAG

**Sealed design**

100HCRRUL

(B7000C.2RSD.T.P4S.UL)

**Hybrid ceramic design**

C100HCUL

(HCB7000C.T.P4S.UL)



# SPINDLE BEARINGS

## 1800HC/E, 1900HC/E, 100HC/E, 200HC/E, ZSB1900C/E, ZSB100C/E

C: Contact Angle  $\alpha = 15^\circ$  / E: Contact Angle  $\alpha = 25^\circ$

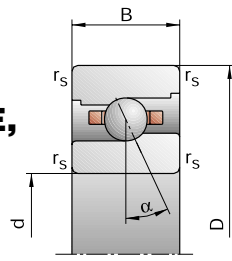

High Speed Design (ZSB)

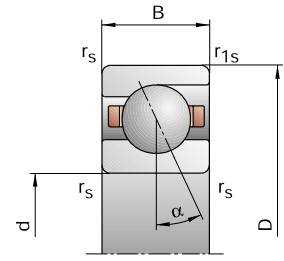

Standard Design

Attainable Speed*		Standard Preload $F_V$ (Force)			Unloading Force $K_{aE}$			Axial Rigidity $S_a$			Sealed Design	Weight	FAG Basic Bearing Number†
Grease	Oil minimal	L	M	H	L	M	H	L	M	H		kg	
min <sup>-1</sup>		N						N/μm					
75000	120000	7	23	54	21	76	194	9.3	16.2	25.4	–	0.005	B71800C.TPA.P4
70000	110000	8	31	80	23	91	246	20.1	33.1	49.2	–	0.005	B71800E.TPA.P4
95000	160000	4	13	33	12	41	112	8.5	13.8	21.5	–	0.005	HCB71800C.TPA.P4
85000	140000	6	21	48	17	62	145	20.2	32.5	44.6	–	0.005	HCB71800E.TPA.P4
70000	110000	14	51	114	44	179	438	12.6	23.5	36.6	•	0.009	B71900C.T.P4S
63000	95000	17	63	149	50	193	476	27.0	44.8	64.5	•	0.009	B71900E.T.P4S
90000	150000	5	20	49	15	65	171	9.2	16.7	25.5	•	0.008	HCB71900C.T.P4S
75000	120000	9	25	70	27	75	217	24.9	35.4	52.7	•	0.008	HCB71900E.T.P4S
110000	180000	5	20	49	15	65	171	9.2	16.7	25.5	•	0.008	XCB71900C.T.P4S
100000	170000	9	25	70	27	75	217	24.9	35.4	52.7	•	0.008	XCB71900E.T.P4S
90000	150000	7	20	39	21	65	134	8.9	14.3	19.8	•	0.010	HS71900C.T.P4S
75000	120000	11	32	64	32	95	195	22.0	32.6	42.9	•	0.010	HS71900E.T.P4S
100000	170000	5	14	27	15	44	90	8.8	13.5	18.4	•	0.010	HC71900C.T.P4S
85000	140000	7	22	44	20	65	133	20.8	31.9	41.6	•	0.010	HC71900E.T.P4S
130000	200000	5	14	27	15	44	90	8.8	13.5	18.4	•	0.010	XC71900C.T.P4S
110000	180000	7	22	44	20	65	133	20.8	31.9	41.6	•	0.010	XC71900E.T.P4S
60000	90000	17	67	145	53	227	531	12.6	23.3	34.9	•	0.02	B7000C.T.P4S
56000	85000	22	100	224	64	303	706	27.9	49.6	69.4	•	0.02	B7000E.T.P4S
80000	130000	7	32	73	21	103	249	9.9	18.4	27.0	•	0.02	HCB7000C.T.P4S
67000	100000	11	43	110	32	128	337	24.8	40.4	58.1	•	0.02	HCB7000E.T.P4S
100000	170000	7	32	73	21	103	249	9.9	18.4	27.0	•	0.02	XCB7000C.T.P4S
85000	140000	11	43	110	32	128	337	24.8	40.4	58.1	•	0.02	XCB7000E.T.P4S
80000	130000	9	27	55	27	87	187	10.7	17.3	24.2	•	0.02	HS7000C.T.P4S
67000	100000	15	44	89	44	131	271	27.2	40.1	52.9	•	0.02	HS7000E.T.P4S
90000	150000	6	19	38	18	60	125	10.3	16.5	22.5	•	0.02	HC7000C.T.P4S
75000	120000	10	31	62	29	92	188	26.3	39.7	51.7	•	0.02	HC7000E.T.P4S
120000	190000	6	19	38	18	60	125	10.3	16.5	22.5	•	0.02	XC7000C.T.P4S
100000	170000	10	31	62	29	92	188	26.3	39.7	51.7	•	0.02	XC7000E.T.P4S
56000	85000	25	92	198	77	313	730	16.2	29.9	44.9	•	0.03	B7200C.T.P4S
50000	75000	31	139	312	89	419	980	35.0	62.5	88.2	•	0.03	B7200E.T.P4S
70000	110000	13	57	126	39	186	441	13.9	26.2	38.8	•	0.03	HCB7200C.T.P4S
60000	90000	22	81	194	64	241	597	35.4	56.9	80.7	•	0.03	HCB7200E.T.P4S

### X-life ultra design

**XC100HCUL**  
(XCB7000C.T.P4S.UL)

† FAG Basic Bearing Number is for reference only. All bearings are available exclusively from Barden, and must be ordered using the Barden Basic Bearing Number.

\* = speeds indicated are for spring preloads.



# SPINDLE BEARINGS

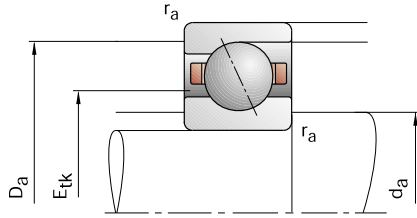

Single

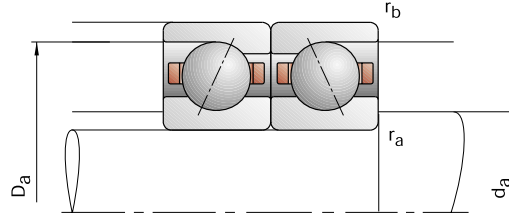

Duplex

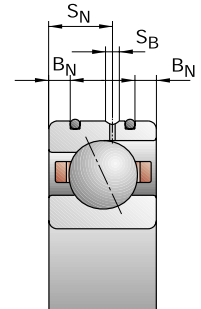

Direct Lube (DLR)

Barden Basic Bearing Number	Dimensions					Shaft & Shoulder Housing Dimensions				DLR Dimensions				Load Ratings			
	d	D	B	r <sub>smin</sub>	r <sub>1smin</sub>	d <sub>a</sub> h12	D <sub>a</sub> H12	r <sub>a</sub> max	r <sub>b</sub> max	B <sub>N</sub>	S <sub>N</sub>	S <sub>B</sub>	E <sub>tk</sub>	C <sub>dyn</sub>	C <sub>0stat</sub>		
	mm															kN	
1801HC	12	21	5	0.30	0.10	14	19	0.3	0.1				15.3	2.08	1.18		
1801HE	12	21	5	0.30	0.10	14	19	0.3	0.1				15.3	1.96	1.12		
C1801HC	12	21	5	0.30	0.10	14	19	0.3	0.1				15.3	1.43	0.83		
C1801HE	12	21	5	0.30	0.10	14	19	0.3	0.1				15.3	1.34	0.78		
1901HC	12	24	6	0.30	0.30	15	21.5	0.3	0.3				17.2	3.35	1.86		
1901HE	12	24	6	0.30	0.30	15	21.5	0.3	0.3				17.2	3.20	1.76		
C1901HC	12	24	6	0.30	0.30	15	21.5	0.3	0.3				17.2	2.32	1.29		
C1901HE	12	24	6	0.30	0.30	15	21.5	0.3	0.3				17.2	2.20	1.22		
XC1901HC	12	24	6	0.30	0.30	15	21.5	0.3	0.3				17.2	5.20	1.29		
XC1901HE	12	24	6	0.30	0.30	15	21.5	0.3	0.3				17.2	5.00	1.22		
ZSB1901C	12	24	6	0.30	0.30	15	21.5	0.3	0.3				17.0	2.04	1.20		
ZSB1901E	12	24	6	0.30	0.30	15	21.5	0.3	0.3				17.0	1.93	1.14		
CZSB1901C	12	24	6	0.30	0.30	15	21.5	0.3	0.3				17.0	1.40	0.83		
CZSB1901E	12	24	6	0.30	0.30	15	21.5	0.3	0.3				17.0	1.34	0.80		
XCZSB1901C	12	24	6	0.30	0.30	15	21.5	0.3	0.3				17.0	3.15	0.83		
XCZSB1901E	12	24	6	0.30	0.30	15	21.5	0.3	0.3				17.0	3.00	0.80		
101HC	12	28	8	0.30	0.30	16.5	24.5	0.3	0.1				18.6	4.75	2.60		
101HE	12	28	8	0.30	0.30	16.5	24.5	0.3	0.1				18.6	4.55	2.50		
C101HC	12	28	8	0.30	0.30	16.5	24.5	0.3	0.1				18.6	3.25	1.80		
C101HE	12	28	8	0.30	0.30	16.5	24.5	0.3	0.1				18.6	3.15	1.73		
XC101HC	12	28	8	0.30	0.30	16.5	24.5	0.3	0.1				18.6	7.20	1.73		
XC101HE	12	28	8	0.30	0.30	16.5	24.5	0.3	0.1				18.6	7.10	1.73		
ZSB101C	12	28	8	0.30	0.30	16.5	24.5	0.3	0.1				18.8	2.70	1.63		
ZSB101E	12	28	8	0.30	0.30	16.5	24.5	0.3	0.1				18.8	2.55	1.53		
CZSB101C	12	28	8	0.30	0.30	16.5	24.5	0.3	0.1				18.8	1.86	1.12		
CZSB101E	12	28	8	0.30	0.30	16.5	24.5	0.3	0.1				18.8	1.76	1.08		
XCZSB101C	12	28	8	0.30	0.30	16.5	24.5	0.3	0.1				18.8	4.15	1.12		
XCZSB101E	12	28	8	0.30	0.30	16.5	24.5	0.3	0.1				18.8	3.90	1.08		
201HC	12	32	10	0.60	0.60	16.5	27.5	0.6	0.6				21.1	7.65	3.90		
201HE	12	32	10	0.60	0.60	16.5	27.5	0.6	0.6				21.1	7.35	3.75		
C201HC	12	32	10	0.60	0.60	16.5	27.5	0.6	0.6				21.1	5.30	2.70		
C201HE	12	32	10	0.60	0.60	16.5	27.5	0.6	0.6				21.1	5.10	2.60		

**Designation examples:**

Barden

FAG

**Sealed design**

101HCRRUL

(B7001C.2RSD.T.P4S.UL)

**Hybrid ceramic design**

C101HCUL

(HCB7001C.T.P4S.UL)

# SPINDLE BEARINGS

## 1800HC/E, 1900HC/E, 100HC/E, 200HC/E, ZSB1900C/E, ZSB100C/E

C: Contact Angle  $\alpha = 15^\circ$  / E: Contact Angle  $\alpha = 25^\circ$

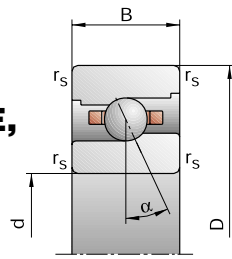

High Speed Design (ZSB)

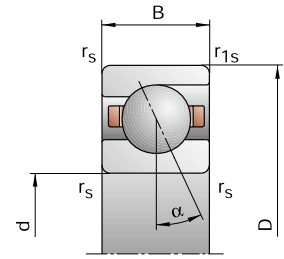

Standard Design

Attainable Speed*	Grease	Oil minimal	Standard Preload $F_V$ (Force)			Unloading Force $K_{aE}$			Axial Rigidity $S_a$			Sealed Design	Weight	FAG Basic Bearing Number†
			L	M	H	L	M	H	L	M	H			
min <sup>-1</sup>			N						N/ $\mu$ m				kg	
67000	100000	7	25	58	21	82	207	10.2	18.3	28.3	–	0.01	B71801C.TPA.P4	
60000	90000	8	33	85	23	97	260	22.3	37.4	55.1	–	0.01	B71801E.TPA.P4	
85000	140000	4	13	35	12	41	118	9.4	15.2	23.9	–	0.01	HCB71801C.TPA.P4	
75000	120000	7	22	51	20	64	153	23.7	35.9	50.0	–	0.01	HCB71801E.TPA.P4	
60000	90000	15	56	126	47	195	479	14.3	26.8	41.5	•	0.01	B71901C.T.P4S	
56000	85000	19	67	162	56	204	515	31.4	50.7	73.5	•	0.01	B71901E.T.P4S	
80000	130000	6	22	54	18	71	187	11.0	19.0	29.1	•	0.01	HCB71901C.T.P4S	
67000	100000	10	26	75	29	78	231	27.9	40.0	59.8	•	0.01	HCB71901E.T.P4S	
100000	170000	6	22	54	18	71	187	11.0	19.0	29.1	•	0.01	XCB71901C.T.P4S	
85000	140000	10	26	75	29	78	231	27.9	40.0	59.8	•	0.01	XCB71901E.T.P4S	
80000	130000	7	21	41	21	68	140	9.3	15.2	21.0	•	0.01	HS71901C.T.P4S	
67000	100000	11	33	66	32	98	201	23.1	34.5	45.4	•	0.01	HS71901E.T.P4S	
90000	150000	5	14	28	15	44	93	9.3	14.1	19.4	•	0.01	HC71901C.T.P4S	
80000	130000	8	23	46	23	68	139	23.0	34.0	44.4	•	0.01	HC71901E.T.P4S	
120000	190000	5	14	28	15	44	93	9.3	14.1	19.4	•	0.01	XC71901C.T.P4S	
100000	170000	8	23	46	23	68	139	23.0	34.0	44.4	•	0.01	XC71901E.T.P4S	
56000	85000	19	74	161	58	249	584	14.5	26.9	40.1	•	0.02	B7001C.T.P4S	
50000	75000	23	110	250	67	332	784	32.0	57.4	80.6	•	0.02	B7001E.T.P4S	
70000	110000	9	44	99	27	141	339	13.1	25.2	37.3	•	0.02	HCB7001C.T.P4S	
60000	90000	15	58	147	43	170	445	32.8	53.6	77.2	•	0.02	HCB7001E.T.P4S	
90000	150000	9	44	99	27	141	339	13.1	25.2	37.3	•	0.02	XCB7001C.T.P4S	
75000	120000	15	58	147	43	170	445	32.8	53.6	77.2	•	0.02	XCB7001E.T.P4S	
70000	110000	9	27	54	27	87	184	10.7	17.3	24.1	•	0.02	HS7001C.T.P4S	
60000	90000	15	44	87	44	131	264	27.2	40.2	52.3	•	0.02	HS7001E.T.P4S	
80000	130000	6	19	38	18	60	125	10.3	16.5	22.5	•	0.02	HC7001C.T.P4S	
70000	110000	10	30	61	29	89	184	26.3	39.2	51.2	•	0.02	HC7001E.T.P4S	
100000	170000	6	19	38	18	60	125	10.3	16.5	22.5	•	0.02	XC7001C.T.P4S	
90000	150000	10	30	61	29	89	184	26.3	39.2	51.2	•	0.02	XC7001E.T.P4S	
50000	75000	35	124	264	108	422	971	19.1	34.7	51.8	•	0.04	B7201C.T.P4S	
45000	67000	47	191	420	136	576	1319	42.7	73.3	102.4	•	0.04	B7201E.T.P4S	
63000	95000	19	78	170	57	254	593	16.6	30.6	45.0	•	0.03	HCB7201C.T.P4S	
56000	85000	32	113	263	93	337	809	42.2	67.2	94.0	•	0.03	HCB7201E.T.P4S	

### X-life ultra design

XC101HCUL

(XCB7001C.T.P4S.UL)

† FAG Basic Bearing Number is for reference only. All bearings are available exclusively from Barden, and must be ordered using the Barden Basic Bearing Number.

\* = speeds indicated are for spring preloads.



# SPINDLE BEARINGS

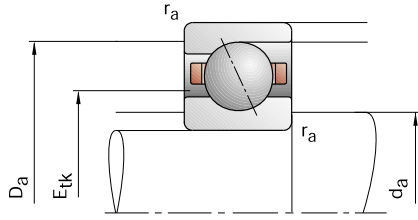

Single

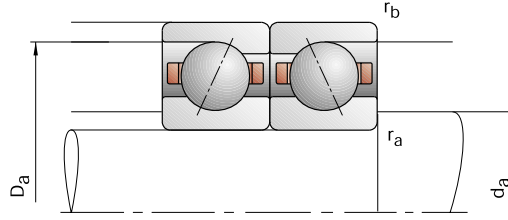

Duplex

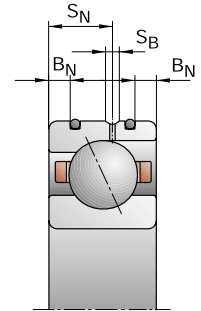

Direct Lube (DLR)

Barden Basic Bearing Number	Dimensions					Shaft & Shoulder Housing Dimensions				DLR Dimensions				Load Ratings			
	d	D	B	r <sub>smin</sub>	r <sub>1smin</sub>	d <sub>a</sub> h12	D <sub>a</sub> H12	r <sub>a</sub> max	r <sub>b</sub> max	B <sub>N</sub>	S <sub>N</sub>	S <sub>B</sub>	E <sub>tk</sub>	C <sub>dyn</sub>	C <sub>0stat</sub>		
	mm															kN	
1802HC	15	24	5	0.30	0.10	17	22	0.3	0.1				18.3	2.28	1.50		
1802HE	15	24	5	0.30	0.10	17	22	0.3	0.1				18.3	2.16	1.40		
C1802HC	15	24	5	0.30	0.10	17	22	0.3	0.1				18.3	1.60	1.04		
C1802HE	15	24	5	0.30	0.10	17	22	0.3	0.1				18.3	1.50	0.98		
1902HC	15	28	7	0.30	0.30	18	25.5	0.3	0.3				20.9	5.00	2.90		
1902HE	15	28	7	0.30	0.30	18	25.5	0.3	0.3				20.9	4.80	2.75		
C1902HC	15	28	7	0.30	0.30	18	25.5	0.3	0.3				20.9	3.45	2.00		
C1902HE	15	28	7	0.30	0.30	18	25.5	0.3	0.3				20.9	3.35	1.93		
XC1902HC	15	28	7	0.30	0.30	18	25.5	0.3	0.3				20.9	7.70	2.00		
XC1902HE	15	28	7	0.30	0.30	18	25.5	0.3	0.3				20.9	7.50	1.93		
ZSB1902C	15	28	7	0.30	0.30	18	25.5	0.3	0.3				20.3	2.80	1.76		
ZSB1902E	15	28	7	0.30	0.30	18	25.5	0.3	0.3				20.3	2.65	1.66		
CZSB1902C	15	28	7	0.30	0.30	18	25.5	0.3	0.3				20.3	1.93	1.22		
CZSB1902E	15	28	7	0.30	0.30	18	25.5	0.3	0.3				20.3	1.83	1.16		
XCZSB1902C	15	28	7	0.30	0.30	18	25.5	0.3	0.3				20.3	4.30	1.22		
XCZSB1902E	15	28	7	0.30	0.30	18	25.5	0.3	0.3				20.3	4.05	1.16		
102HC	15	32	9	0.30	0.30	19	29	0.3	0.1				22.3	6.20	3.40		
102HE	15	32	9	0.30	0.30	19	29	0.3	0.1				22.3	6.00	3.25		
C102HC	15	32	9	0.30	0.30	19	29	0.3	0.1				22.3	4.30	2.36		
C102HE	15	32	9	0.30	0.30	19	29	0.3	0.1				22.3	4.15	2.24		
XC102HC	15	32	9	0.30	0.30	19	29	0.3	0.1				22.3	9.65	2.36		
XC102HE	15	32	9	0.30	0.30	19	29	0.3	0.1				22.3	9.30	2.24		
ZSB102C	15	32	9	0.30	0.30	19	29	0.3	0.1				22.2	3.75	2.45		
ZSB102E	15	32	9	0.30	0.30	19	29	0.3	0.1				22.2	3.55	2.32		
CZSB102C	15	32	9	0.30	0.30	19	29	0.3	0.1				22.2	2.60	1.70		
CZSB102E	15	32	9	0.30	0.30	19	29	0.3	0.1				22.2	2.45	1.60		
XCZSB102C	15	32	9	0.30	0.30	19	29	0.3	0.1				22.2	5.85	1.70		
XCZSB102E	15	32	9	0.30	0.30	19	29	0.3	0.1				22.2	5.50	1.60		
202HC	15	35	11	0.60	0.60	19.5	30.5	0.6	0.6				23.3	9.65	5.00		
202HE	15	35	11	0.60	0.60	19.5	30.5	0.6	0.6				23.3	9.30	4.80		
C202HC	15	35	11	0.60	0.60	19.5	30.5	0.6	0.6				23.3	6.70	3.45		
C202HE	15	35	11	0.60	0.60	19.5	30.5	0.6	0.6				23.3	6.40	3.35		

**Designation examples:**

Barden

FAG

**Sealed design**

102HCRRUL

(B7002C.2RSD.T.P4S.UL)

**Hybrid ceramic design**

C102HCUL

(HCB7002C.T.P4S.UL)

# SPINDLE BEARINGS

## 1800HC/E, 1900HC/E, 100HC/E, 200HC/E, ZSB1900C/E, ZSB100C/E

C: Contact Angle  $\alpha = 15^\circ$  / E: Contact Angle  $\alpha = 25^\circ$

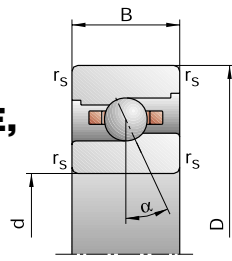

High Speed Design (ZSB)

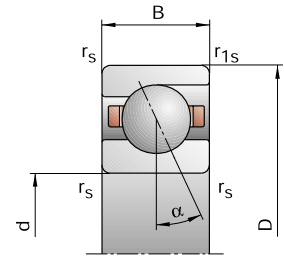

Standard Design

Attainable Speed*	Grease	Oil minimal	Standard Preload $F_V$ (Force)			Unloading Force $K_{aE}$			Axial Rigidity $S_a$			Sealed Design	Weight	FAG Basic Bearing Number†
			L	M	H	L	M	H	L	M	H			
min <sup>-1</sup>			N						N/μm				kg	
56000	85000	8	27	63	24	88	222	12.2	21.0	32.4	–	0.01	B71802C.TPA.P4	
50000	75000	8	34	91	23	99	277	25.3	42.4	63.5	–	0.01	B71802E.TPA.P4	
70000	110000	4	14	37	12	44	123	10.6	17.5	27.1	–	0.01	HCB71802C.TPA.P4	
63000	95000	7	22	54	20	64	161	27.0	40.8	57.4	–	0.01	HCB71802E.TPA.P4	
50000	75000	20	77	167	63	265	624	17.0	31.4	47.4	•	0.02	B71902C.T.P4S	
48000	70000	22	112	259	64	342	824	35.0	65.2	92.8	•	0.02	B71902E.T.P4S	
67000	100000	11	38	87	34	124	303	15.0	25.0	37.0	•	0.01	HCB71902C.T.P4S	
56000	85000	17	48	125	50	144	386	36.3	53.1	76.7	•	0.01	HCB71902E.T.P4S	
85000	140000	11	38	87	34	124	303	15.0	25.0	37.0	•	0.01	XCB71902C.T.P4S	
70000	110000	17	48	125	50	144	386	36.3	53.1	76.7	•	0.01	XCB71902E.T.P4S	
67000	100000	9	28	56	27	90	190	11.2	18.2	25.4	•	0.02	HS71902C.T.P4S	
56000	85000	15	46	92	43	136	279	27.8	42.4	55.7	•	0.02	HS71902E.T.P4S	
75000	120000	6	19	38	18	60	125	10.8	17.3	23.4	•	0.02	HC71902C.T.P4S	
63000	95000	11	32	63	32	95	190	28.5	42.0	54.1	•	0.02	HC71902E.T.P4S	
100000	160000	6	19	38	18	60	125	10.8	17.3	23.4	•	0.02	XC71902C.T.P4S	
85000	140000	11	32	63	32	95	190	28.5	42.0	54.1	•	0.02	XC71902E.T.P4S	
48000	70000	28	102	216	87	345	787	16.9	30.2	44.6	•	0.03	B7002C.T.P4S	
43000	63000	36	154	344	105	467	1080	37.4	64.8	90.3	•	0.03	B7002E.T.P4S	
60000	90000	11	51	114	33	164	388	13.0	24.4	35.4	•	0.03	HCB7002C.T.P4S	
50000	75000	18	68	166	53	203	508	33.4	53.5	75.2	•	0.03	HCB7002E.T.P4S	
75000	120000	11	51	114	33	164	388	13.0	24.4	35.4	•	0.03	XCB7002C.T.P4S	
67000	100000	18	68	166	53	203	508	33.4	53.5	75.2	•	0.03	XCB7002E.T.P4S	
60000	90000	13	38	75	39	122	254	13.8	22.0	30.4	•	0.03	HS7002C.T.P4S	
50000	75000	20	61	122	58	181	370	33.7	50.9	66.7	•	0.03	HS7002E.T.P4S	
70000	110000	9	26	52	27	82	171	13.5	20.9	28.3	•	0.03	HC7002C.T.P4S	
60000	90000	14	42	84	41	125	254	33.9	50.2	65.1	•	0.03	HC7002E.T.P4S	
90000	150000	9	26	52	27	82	171	13.5	20.9	28.3	•	0.03	XC7002C.T.P4S	
80000	130000	14	42	84	41	125	254	33.9	50.2	65.1	•	0.03	XC7002E.T.P4S	
45000	67000	47	165	347	149	575	1309	22.4	40.4	60.2	•	0.04	B7202C.T.P4S	
40000	60000	65	256	555	192	789	1779	50.2	85.3	118.6	•	0.04	B7202E.T.P4S	
56000	85000	21	86	186	64	283	653	17.9	32.7	47.5	•	0.04	HCB7202C.T.P4S	
48000	70000	24	123	286	71	372	892	40.1	72.1	100.5	•	0.04	HCB7202E.T.P4S	

### X-life ultra design

**XC102HCUL**  
(XCB7002C.T.P4S.UL)

† FAG Basic Bearing Number is for reference only. All bearings are available exclusively from Barden, and must be ordered using the Barden Basic Bearing Number.

\* = speeds indicated are for spring preloads.



# SPINDLE BEARINGS

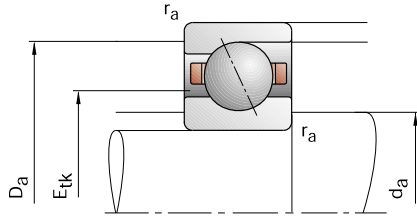

Single

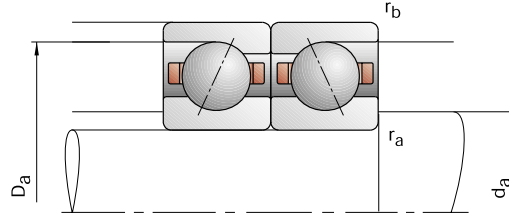

Duplex

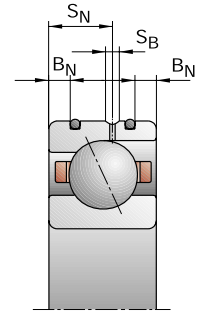

Direct Lube (DLR)

Barden Basic Bearing Number	Dimensions					Shaft & Shoulder Housing Dimensions				DLR Dimensions				Load Ratings			
	d	D	B	r <sub>smin</sub>	r <sub>1smin</sub>	d <sub>a</sub> h12	D <sub>a</sub> H12	r <sub>a</sub> max	r <sub>b</sub> max	B <sub>N</sub>	S <sub>N</sub>	S <sub>B</sub>	E <sub>tk</sub>	C <sub>dyn</sub>	C <sub>0stat</sub>		
	mm															kN	
1803HC	17	26	5	0.30	0.10	19	24	0.3	0.1				20.3	2.32	1.60		
1803HE	17	26	5	0.30	0.10	19	24	0.3	0.1				20.3	2.20	1.53		
C1803HC	17	26	5	0.30	0.10	19	24	0.3	0.1				20.3	1.60	1.12		
C1803HE	17	26	5	0.30	0.10	19	24	0.3	0.1				20.3	1.53	1.06		
1903HC	17	30	7	0.30	0.30	20	27.5	0.3	0.3				22.2	5.30	3.15		
1903HE	17	30	7	0.30	0.30	20	27.5	0.3	0.3				22.2	5.00	3.00		
C1903HC	17	30	7	0.30	0.30	20	27.5	0.3	0.3				22.2	3.65	2.20		
C1903HE	17	30	7	0.30	0.30	20	27.5	0.3	0.3				22.2	3.45	2.08		
XC1903HC	17	30	7	0.30	0.30	20	27.5	0.3	0.3				22.2	8.15	2.20		
XC1903HE	17	30	7	0.30	0.30	20	27.5	0.3	0.3				22.2	7.65	2.08		
ZSB1903C	17	30	7	0.30	0.30	20	27.5	0.3	0.3				22.3	2.90	1.90		
ZSB1903E	17	30	7	0.30	0.30	20	27.5	0.3	0.3				22.3	2.70	1.80		
CZSB1903C	17	30	7	0.30	0.30	20	27.5	0.3	0.3				22.3	2.00	1.34		
CZSB1903E	17	30	7	0.30	0.30	20	27.5	0.3	0.3				22.3	1.90	1.27		
XCZSB1903C	17	30	7	0.30	0.30	20	27.5	0.3	0.3				22.3	4.50	1.34		
XCZSB1903E	17	30	7	0.30	0.30	20	27.5	0.3	0.3				22.3	4.25	1.27		
103HC	17	35	10	0.30	0.30	21	32	0.3	0.1				24.1	8.65	4.90		
103HE	17	35	10	0.30	0.30	21	32	0.3	0.1				24.1	8.30	4.75		
C103HC	17	35	10	0.30	0.30	21	32	0.3	0.1				24.1	6.00	3.45		
C103HE	17	35	10	0.30	0.30	21	32	0.3	0.1				24.1	5.70	3.25		
XC103HC	17	35	10	0.30	0.30	21	32	0.3	0.1				24.1	13.40	3.45		
XC103HE	17	35	10	0.30	0.30	21	32	0.3	0.1				24.1	12.70	3.25		
ZSB103C	17	35	10	0.30	0.30	21	32	0.3	0.1				24.7	3.80	2.65		
ZSB103E	17	35	10	0.30	0.30	21	32	0.3	0.1				24.7	3.65	2.50		
CZSB103C	17	35	10	0.30	0.30	21	32	0.3	0.1				24.7	2.65	1.83		
CZSB103E	17	35	10	0.30	0.30	21	32	0.3	0.1				24.7	2.50	1.73		
XCZSB103C	17	35	10	0.30	0.30	21	32	0.3	0.1				24.7	5.85	1.83		
XCZSB103E	17	35	10	0.30	0.30	21	32	0.3	0.1				24.7	5.60	1.73		
203HC	17	40	12	0.60	0.60	22.5	34.5	0.6	0.6				26.7	10.80	5.85		
203HE	17	40	12	0.60	0.60	22.5	34.5	0.6	0.6				26.7	10.40	5.60		
C203HC	17	40	12	0.60	0.60	22.5	34.5	0.6	0.6				26.7	7.50	4.05		
C203HE	17	40	12	0.60	0.60	22.5	34.5	0.6	0.6				26.7	7.20	3.90		

**Designation examples:**

Barden

FAG

**Sealed design**

103HCRRUL

(B7003C.2RSD.T.P4S.UL)

**Hybrid ceramic design**

C103HCUL

(HC B7003C.T.P4S.UL)



# SPINDLE BEARINGS

## 1800HC/E, 1900HC/E, 100HC/E, 200HC/E, ZSB1900C/E, ZSB100C/E

C: Contact Angle  $\alpha = 15^\circ$  / E: Contact Angle  $\alpha = 25^\circ$

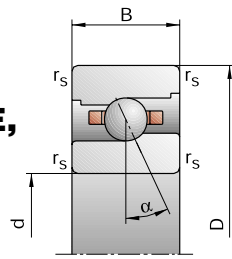

High Speed Design (ZSB)

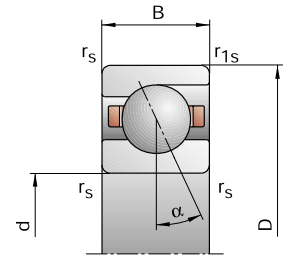

Standard Design

Attainable Speed*		Standard Preload $F_V$ (Force)			Unloading Force $K_{aE}$			Axial Rigidity $S_a$			Sealed Design	Weight	FAG Basic Bearing Number†
Grease	Oil minimal	L	M	H	L	M	H	L	M	H		kg	
min <sup>-1</sup>		N											
		N/μm											
50000	75000	8	26	64	24	84	224	12.6	21.3	33.4	–	0.01	B71803C.TPA.P4
48000	70000	7	33	92	20	96	279	24.9	43.5	65.8	–	0.01	B71803E.TPA.P4
67000	100000	4	13	36	12	40	119	11.0	17.3	27.6	–	0.01	HCB71803C.TPA.P4
56000	85000	7	22	53	20	64	158	28.0	42.3	59.1	–	0.01	HCB71803E.TPA.P4
48000	70000	21	81	176	66	279	656	18.1	33.5	50.4	•	0.02	B71903C.T.P4S
43000	63000	23	116	268	67	354	850	37.4	69.2	98.1	•	0.02	B71903E.T.P4S
60000	90000	11	39	91	34	127	316	15.7	26.4	39.3	•	0.01	HCB71903C.T.P4S
50000	75000	18	50	132	53	150	407	38.9	56.5	81.9	•	0.01	HCB71903E.T.P4S
75000	120000	11	39	91	34	127	316	15.7	26.4	39.3	•	0.01	XCB71903C.T.P4S
67000	100000	18	50	132	53	150	407	38.9	56.5	81.9	•	0.01	XCB71903E.T.P4S
60000	90000	10	29	58	30	93	196	12.1	19.2	26.6	•	0.02	HS71903C.T.P4S
50000	75000	16	47	94	46	139	285	29.7	44.5	58.5	•	0.02	HS71903E.T.P4S
70000	110000	7	20	40	21	63	131	11.9	18.3	24.8	•	0.02	HC71903C.T.P4S
60000	90000	11	32	64	32	95	193	29.7	43.8	56.7	•	0.02	HC71903E.T.P4S
90000	150000	7	20	40	21	63	131	11.9	18.3	24.8	•	0.02	XC71903C.T.P4S
75000	120000	11	32	64	32	95	193	29.7	43.8	56.7	•	0.02	XC71903E.T.P4S
43000	63000	41	146	308	127	492	1115	21.3	37.8	55.4	•	0.04	B7003C.T.P4S
38000	56000	54	221	487	158	668	1527	47.9	81.3	112.6	•	0.04	B7003E.T.P4S
53000	80000	18	73	163	54	234	553	17.2	30.5	44.2	•	0.03	HCB7003C.T.P4S
45000	67000	28	104	249	82	311	762	43.0	68.9	96.1	•	0.03	HCB7003E.T.P4S
70000	110000	18	73	163	54	234	553	17.2	30.5	44.2	•	0.03	XCB7003C.T.P4S
60000	90000	28	104	249	82	311	762	43.0	68.9	96.1	•	0.03	XCB7003E.T.P4S
53000	80000	13	38	76	39	121	256	14.3	22.6	31.5	•	0.04	HS7003C.T.P4S
45000	67000	21	62	124	61	183	375	35.7	53.0	69.5	•	0.04	HS7003E.T.P4S
63000	95000	9	26	53	27	81	173	14.1	21.4	29.4	•	0.04	HC7003C.T.P4S
53000	80000	14	43	86	41	127	259	35.3	52.3	68.0	•	0.04	HC7003E.T.P4S
80000	130000	9	26	53	27	81	173	14.1	21.4	29.4	•	0.04	XC7003C.T.P4S
70000	100000	14	43	86	41	127	259	35.3	52.3	68.0	•	0.04	XC7003E.T.P4S
38000	56000	53	186	391	167	647	1470	23.7	42.9	63.7	•	0.06	B7203C.T.P4S
36000	53000	75	289	626	222	891	2006	53.9	90.7	126.0	•	0.06	B7203E.T.P4S
50000	75000	25	98	212	77	323	744	19.6	34.9	50.6	•	0.06	HCB7203C.T.P4S
43000	63000	28	142	327	82	430	1020	42.7	77.3	107.3	•	0.06	HCB7203E.T.P4S

### X-life ultra design

**XC103HCUL**  
(XCB7003C.T.P4S.UL)

† FAG Basic Bearing Number is for reference only. All bearings are available exclusively from Barden, and must be ordered using the Barden Basic Bearing Number.

\* = speeds indicated are for spring preloads.



# SPINDLE BEARINGS

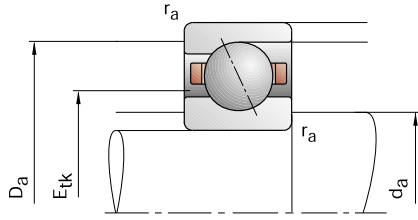

Single

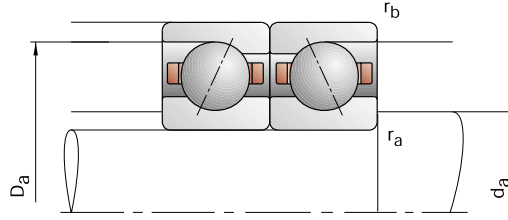

Duplex

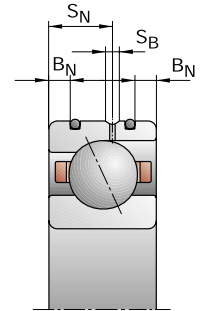

Direct Lube (DLR)

Barden Basic Bearing Number	Dimensions					Shaft & Shoulder Housing Dimensions				DLR Dimensions				Load Ratings	
	d	D	B	r <sub>smin</sub>	r <sub>1smin</sub>	d <sub>a</sub> h12	D <sub>a</sub> H12	r <sub>a</sub> max	r <sub>b</sub> max	B <sub>N</sub>	S <sub>N</sub>	S <sub>B</sub>	E <sub>tk</sub>	C <sub>dyn</sub>	C <sub>0stat</sub>
mm															
1804HC	20	32	7	0.30	0.10	23	29	0.3	0.1				24.5	3.80	2.65
1804HE	20	32	7	0.30	0.10	23	29	0.3	0.1				24.5	3.65	2.50
C1804HC	20	32	7	0.30	0.10	23	29	0.3	0.1				24.5	2.65	1.83
C1804HE	20	32	7	0.30	0.10	23	29	0.3	0.1				24.5	2.50	1.73
1904HC	20	37	9	0.30	0.30	24	33.5	0.3	0.3				26.8	7.35	4.55
1904HE	20	37	9	0.30	0.30	24	33.5	0.3	0.3				26.8	6.95	4.40
C1904HC	20	37	9	0.30	0.30	24	33.5	0.3	0.3				26.8	5.00	3.20
C1904HE	20	37	9	0.30	0.30	24	33.5	0.3	0.3				26.8	4.80	3.05
XC1904HC	20	37	9	0.30	0.30	24	33.5	0.3	0.3				26.8	11.20	3.20
XC1904HE	20	37	9	0.30	0.30	24	33.5	0.3	0.3				26.8	10.80	3.05
ZSB1904C	20	37	9	0.30	0.30	24	33.5	0.3	0.3				27.2	3.90	2.85
ZSB1904E	20	37	9	0.30	0.30	24	33.5	0.3	0.3				27.2	3.75	2.70
CZSB1904C	20	37	9	0.30	0.30	24	33.5	0.3	0.3				27.2	2.70	1.96
CZSB1904E	20	37	9	0.30	0.30	24	33.5	0.3	0.3				27.2	2.55	1.86
XCZSB1904C	20	37	9	0.30	0.30	24	33.5	0.3	0.3				27.2	6.00	1.96
XCZSB1904E	20	37	9	0.30	0.30	24	33.5	0.3	0.3				27.2	5.70	1.86
104HC	20	42	12	0.60	0.60	25	37	0.6	0.3				28.8	10.40	6.00
104HE	20	42	12	0.60	0.60	25	37	0.6	0.3				28.8	10.00	5.70
C104HC	20	42	12	0.60	0.60	25	37	0.6	0.3	2.2	6.6	1.4	28.8	7.20	4.15
C104HE	20	42	12	0.60	0.60	25	37	0.6	0.3	2.2	6.6	1.4	28.8	6.95	4.00
XC104HC	20	42	12	0.60	0.60	25	37	0.6	0.3	2.2	6.6	1.4	28.8	16.00	4.15
XC104HE	20	42	12	0.60	0.60	25	37	0.6	0.3	2.2	6.6	1.4	28.8	15.60	4.00
ZSB104C	20	42	12	0.60	0.60	25	37	0.6	0.3				29.3	6.20	4.55
ZSB104E	20	42	12	0.60	0.60	25	37	0.6	0.3				29.3	5.85	4.30
CZSB104C	20	42	12	0.60	0.60	25	37	0.6	0.3	2.2	6.6	1.4	29.3	4.30	3.20
CZSB104E	20	42	12	0.60	0.60	25	37	0.6	0.3	2.2	6.6	1.4	29.3	4.05	3.00
XCZSB104C	20	42	12	0.60	0.60	25	37	0.6	0.3	2.2	6.6	1.4	29.3	9.50	3.20
XCZSB104E	20	42	12	0.60	0.60	25	37	0.6	0.3	2.2	6.6	1.4	29.3	9.00	3.00
204HC	20	47	14	1.00	1.00	26.5	40.5	1.0	1.0				31.7	14.60	8.15
204HE	20	47	14	1.00	1.00	26.5	40.5	1.0	1.0				31.7	14.00	7.80
C204HC	20	47	14	1.00	1.00	26.5	40.5	1.0	1.0				31.7	10.00	5.60
C204HE	20	47	14	1.00	1.00	26.5	40.5	1.0	1.0				31.7	9.65	5.40

**Designation examples:**

Barden

FAG

**Sealed design**

104HCRRUL

(B7004C.2RSD.T.P4S.UL)

**Hybrid ceramic design**

C104HCUL

(HCB7004C.T.P4S.UL)

# SPINDLE BEARINGS

## 1800HC/E, 1900HC/E, 100HC/E, 200HC/E, ZSB1900C/E, ZSB100C/E

C: Contact Angle  $\alpha = 15^\circ$  / E: Contact Angle  $\alpha = 25^\circ$

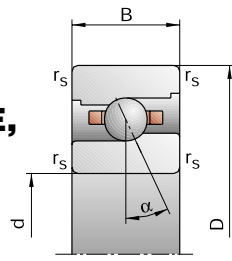

High Speed Design (ZSB)

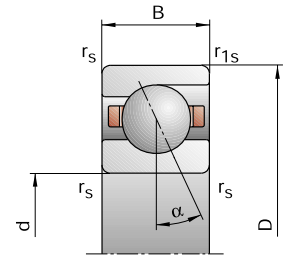

Standard Design

Attainable Speed*		Standard Preload $F_V$ (Force)			Unloading Force $K_{aE}$			Axial Rigidity $S_a$			Sealed Design	Weight	FAG Basic Bearing Number†
Grease	Oil minimal	L	M	H	L	M	H	L	M	H		kg	
min <sup>-1</sup>		N						N/μm					
43000	63000	15	50	114	46	166	411	17.2	29.7	45.6	–	0.02	B71804C.TPA.P4
38000	56000	18	70	174	52	208	539	37.3	61.8	90.2	–	0.02	B71804E.TPA.P4
53000	80000	8	29	70	24	92	239	15.0	25.5	38.9	–	0.02	HCB71804C.TPA.P4
45000	67000	13	48	108	38	142	328	37.9	60.4	82.8	–	0.02	HCB71804E.TPA.P4
38000	56000	41	137	297	130	478	1127	24.5	43.5	66.1	•	0.03	B71904C.T.P4S
36000	53000	38	172	390	111	526	1240	47.1	84.0	118.4	•	0.03	B71904E.T.P4S
50000	75000	13	58	132	39	189	457	17.0	32.1	47.2	•	0.03	HCB71904C.T.P4S
43000	63000	27	77	193	80	231	595	47.7	69.4	98.9	•	0.03	HCB71904E.T.P4S
63000	95000	13	58	132	39	189	457	17.0	32.1	47.2	•	0.03	XCB71904C.T.P4S
56000	85000	27	77	193	80	231	595	47.7	69.4	98.9	•	0.03	XCB71904E.T.P4S
50000	75000	13	39	78	39	124	262	14.8	23.6	32.8	•	0.04	HS71904C.T.P4S
43000	63000	21	63	127	61	186	384	37.1	55.3	72.7	•	0.04	HS71904E.T.P4S
56000	85000	9	27	55	27	84	180	14.6	22.5	31.0	•	0.04	HC71904C.T.P4S
48000	70000	15	44	89	44	130	268	37.6	54.7	71.4	•	0.04	HC71904E.T.P4S
75000	120000	9	27	55	27	84	180	14.6	22.5	31.0	•	0.04	XC71904C.T.P4S
63000	95000	15	44	89	44	130	268	37.6	54.7	71.4	•	0.04	XC71904E.T.P4S
36000	53000	52	179	377	161	604	1369	22.8	40.0	58.8	•	0.07	B7004C.T.P4S
32000	48000	71	277	598	207	839	1879	51.7	86.7	119.3	•	0.07	B7004E.T.P4S
45000	67000	24	94	203	73	303	692	18.9	33.0	47.2	•	0.06	HCB7004C.T.P4S
38000	56000	26	132	305	76	394	934	41.3	73.6	101.6	•	0.06	HCB7004E.T.P4S
60000	90000	24	94	203	73	303	692	18.9	33.0	47.2	•	0.06	XCB7004C.T.P4S
50000	75000	26	132	305	76	394	934	41.3	73.6	101.6	•	0.06	XCB7004E.T.P4S
45000	67000	21	62	125	63	198	420	19.8	31.5	43.7	•	0.08	HS7004C.T.P4S
38000	56000	34	101	202	98	299	610	49.1	73.6	96.3	•	0.08	HS7004E.T.P4S
53000	80000	15	44	87	45	138	284	19.7	30.3	40.9	•	0.08	HC7004C.T.P4S
45000	67000	23	70	140	67	207	421	48.8	72.6	94.2	•	0.08	HC7004E.T.P4S
67000	100000	15	44	87	45	138	284	19.7	30.3	40.9	•	0.08	XC7004C.T.P4S
56000	85000	23	70	140	67	207	421	48.8	72.6	94.2	•	0.08	XC7004E.T.P4S
32000	48000	74	252	527	229	856	1934	27.8	49.4	73.1	•	0.10	B7204C.T.P4S
30000	45000	105	393	843	304	1184	2644	63.0	105.0	145.2	•	0.10	B7204E.T.P4S
43000	63000	45	163	347	137	533	1211	25.4	44.3	64.3	•	0.09	HCB7204C.T.P4S
36000	53000	56	242	538	162	724	1655	56.9	97.9	134.4	•	0.09	HCB7204E.T.P4S

**Direct lube design**  
Consult Barden  
(HCB7004EDLR.T.P4S.UL)

**X-life ultra design**  
**XC104HCUL**  
(XCB7004C.T.P4S.UL)

† FAG Basic Bearing Number is for reference only. All bearings are available exclusively from Barden, and must be ordered using the Barden Basic Bearing Number.

\* = speeds indicated are for spring preloads.



# SPINDLE BEARINGS

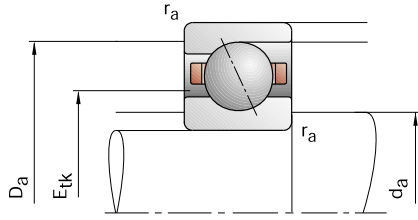

Single

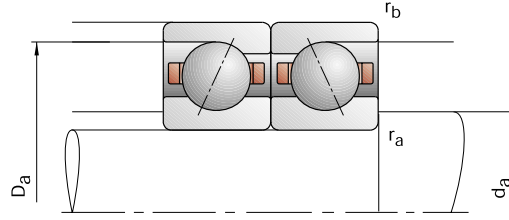

Duplex

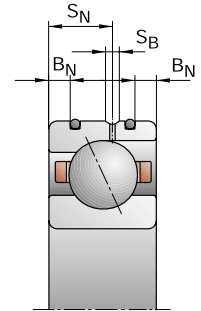

Direct Lube (DLR)

Barden Basic Bearing Number	Dimensions					Shaft & Shoulder Housing Dimensions				DLR Dimensions				Load Ratings	
	d	D	B	r <sub>smin</sub>	r <sub>1smin</sub>	d <sub>a</sub>	D <sub>a</sub>	r <sub>a</sub>	r <sub>b</sub>	B <sub>N</sub>	S <sub>N</sub>	S <sub>B</sub>	E <sub>tk</sub>	C <sub>dyn</sub>	C <sub>0stat</sub>
	mm														
1805HC	25	37	7	0.30	0.10	28	34	0.3	0.1				29.5	4.15	3.20
1805HE	25	37	7	0.30	0.10	28	34	0.3	0.1				29.5	3.90	3.00
C1805HC	25	37	7	0.30	0.10	28	34	0.3	0.1				29.5	2.85	2.24
C1805HE	25	37	7	0.30	0.10	28	34	0.3	0.1				29.5	2.70	2.12
1905HC	25	42	9	0.30	0.30	29	38.5	0.3	0.3				31.8	8.15	5.70
1905HE	25	42	9	0.30	0.30	29	38.5	0.3	0.3				31.8	7.80	5.50
C1905HC	25	42	9	0.30	0.30	29	38.5	0.3	0.3				31.8	5.60	4.00
C1905HE	25	42	9	0.30	0.30	29	38.5	0.3	0.3				31.8	5.30	3.80
XC1905HC	25	42	9	0.30	0.30	29	38.5	0.3	0.3				31.8	12.50	4.00
XC1905HE	25	42	9	0.30	0.30	29	38.5	0.3	0.3				31.8	11.80	3.80
ZSB1905C	25	42	9	0.30	0.30	29	38.5	0.3	0.3				32.2	4.25	3.35
ZSB1905E	25	42	9	0.30	0.30	29	38.5	0.3	0.3				32.2	4.00	3.15
CZSB1905C	25	42	9	0.30	0.30	29	38.5	0.3	0.3				32.2	2.90	2.36
CZSB1905E	25	42	9	0.30	0.30	29	38.5	0.3	0.3				32.2	2.75	2.20
XCZSB1905C	25	42	9	0.30	0.30	29	38.5	0.3	0.3				32.2	6.40	2.36
XCZSB1905E	25	42	9	0.30	0.30	29	38.5	0.3	0.3				32.2	6.10	2.20
105HC	25	47	12	0.60	0.60	30	42	0.6	0.3				33.5	14.60	9.15
105HE	25	47	12	0.60	0.60	30	42	0.6	0.3				33.5	13.70	8.65
C105HC	25	47	12	0.60	0.60	30	42	0.6	0.3	2.2	6.6	1.4	33.5	10.00	6.30
C105HE	25	47	12	0.60	0.60	30	42	0.6	0.3	2.2	6.6	1.4	33.5	9.50	6.00
XC105HC	25	47	12	0.60	0.60	30	42	0.6	0.3	2.2	6.6	1.4	33.5	22.40	6.30
XC105HE	25	47	12	0.60	0.60	30	42	0.6	0.3	2.2	6.6	1.4	33.5	21.20	6.00
ZSB105C	25	47	12	0.60	0.60	30	42	0.6	0.3				34.3	6.30	4.90
ZSB105E	25	47	12	0.60	0.60	30	42	0.6	0.3				34.3	6.00	4.65
CZSB105C	25	47	12	0.60	0.60	30	42	0.6	0.3	2.2	6.6	1.4	34.3	4.30	3.45
CZSB105E	25	47	12	0.60	0.60	30	42	0.6	0.3	2.2	6.6	1.4	34.3	4.05	3.25
XCZSB105C	25	47	12	0.60	0.60	30	42	0.6	0.3	2.2	6.6	1.4	34.3	9.65	3.45
XCZSB105E	25	47	12	0.60	0.60	30	42	0.6	0.3	2.2	6.6	1.4	34.3	9.00	3.25
205HC	25	52	15	1.00	1.00	31.5	45.5	1.0	1.0				36.5	15.60	9.30
205HE	25	52	15	1.00	1.00	31.5	45.5	1.0	1.0				36.5	15.00	9.00
C205HC	25	52	15	1.00	1.00	31.5	45.5	1.0	1.0				36.5	10.80	6.55
C205HE	25	52	15	1.00	1.00	31.5	45.5	1.0	1.0				36.5	10.40	6.20

**Designation examples:**

Barden

FAG

**Sealed design**

105HCRRUL

(B7005C.2RSD.T.P4S.UL)

**Hybrid ceramic design**

C105HCUL

(HCB7005C.T.P4S.UL)

# SPINDLE BEARINGS

## 1800HC/E, 1900HC/E, 100HC/E, 200HC/E, ZSB1900C/E, ZSB100C/E

C: Contact Angle  $\alpha = 15^\circ$  / E: Contact Angle  $\alpha = 25^\circ$

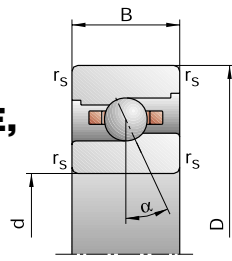

High Speed Design (ZSB)

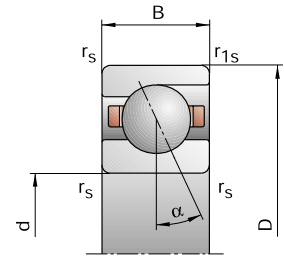

Standard Design

Attainable Speed*		Standard Preload $F_V$ (Force)			Unloading Force $K_{aE}$			Axial Rigidity $S_a$			Sealed Design	Weight	FAG Basic Bearing Number†
Grease	Oil minimal	L	M	H	L	M	H	L	M	H		kg	
min <sup>-1</sup>		N						N/μm					
36000	53000	16	54	123	49	178	439	19.5	33.5	51.2	–	0.02	B71805C.TPA.P4
32000	48000	18	72	181	52	213	557	41.5	69.0	100.6	–	0.02	B71805E.TPA.P4
45000	67000	8	29	73	24	91	247	16.6	27.9	43.2	–	0.02	HCB71805C.TPA.P4
38000	56000	11	49	110	32	144	333	39.7	67.1	92.2	–	0.02	HCB71805E.TPA.P4
32000	48000	40	141	326	125	484	1221	27.0	48.6	75.7	•	0.04	B71905C.T.P4S
30000	45000	40	189	430	117	575	1358	54.5	97.9	137.7	•	0.04	B71905E.T.P4S
43000	63000	13	64	147	39	207	505	19.3	37.3	54.9	•	0.04	HCB71905C.T.P4S
36000	53000	30	84	214	88	251	658	55.7	80.9	116.0	•	0.04	HCB71905E.T.P4S
53000	80000	13	64	147	39	207	505	19.3	37.3	54.9	•	0.04	XCB71905C.T.P4S
48000	70000	30	84	214	88	251	658	55.7	80.9	116.0	•	0.04	XCB71905E.T.P4S
43000	63000	14	42	84	42	133	280	16.8	26.6	36.8	•	0.05	HS71905C.T.P4S
36000	53000	23	69	138	66	203	416	41.9	62.9	82.4	•	0.05	HS71905E.T.P4S
48000	70000	10	29	58	30	90	188	16.7	25.4	34.4	•	0.05	HC71905C.T.P4S
40000	60000	16	47	94	47	139	282	42.6	62.0	80.1	•	0.05	HC71905E.T.P4S
63000	95000	10	29	58	30	90	188	16.7	25.4	34.4	•	0.05	XC71905C.T.P4S
53000	80000	16	47	94	47	139	282	42.6	62.0	80.1	•	0.05	XC71905E.T.P4S
30000	45000	74	254	533	229	852	1921	29.7	51.8	75.7	•	0.08	B7005C.T.P4S
28000	43000	101	384	828	295	1161	2586	67.6	111.9	153.4	•	0.08	B7005E.T.P4S
38000	56000	34	130	281	103	416	950	24.6	42.4	60.4	•	0.06	HCB7005C.T.P4S
34000	50000	39	189	431	114	564	1318	54.9	96.4	132.1	•	0.06	HCB7005E.T.P4S
50000	75000	34	130	281	103	416	950	24.6	42.4	60.4	•	0.06	XCB7005C.T.P4S
43000	63000	39	189	431	114	564	1318	54.9	96.4	132.1	•	0.06	XCB7005E.T.P4S
38000	56000	21	64	127	63	204	426	20.5	32.9	45.3	•	0.09	HS7005C.T.P4S
34000	50000	35	104	207	101	307	624	51.4	76.7	100.3	•	0.09	HS7005E.T.P4S
45000	67000	15	44	87	45	138	283	20.3	31.3	42.1	•	0.09	HC7005C.T.P4S
38000	56000	24	71	143	70	210	430	51.3	75.5	98.1	•	0.09	HC7005E.T.P4S
60000	90000	15	44	87	45	138	283	20.3	31.3	42.1	•	0.09	XC7005C.T.P4S
50000	75000	24	71	143	70	210	430	51.3	75.5	98.1	•	0.09	XC7005E.T.P4S
28000	43000	79	269	562	244	911	2054	30.2	53.5	79.0	•	0.12	B7205C.T.P4S
26000	40000	113	420	901	327	1264	2821	68.8	114.2	157.7	•	0.12	B7205E.T.P4S
36000	53000	47	172	367	142	560	1275	27.3	47.8	69.2	•	0.11	HCB7205C.T.P4S
32000	48000	58	252	563	168	750	1728	61.4	105.2	144.9	•	0.11	HCB7205E.T.P4S

**Direct lube design**  
Consult Barden  
(HCB7005EDLR.T.P4S.UL)

**X-life ultra design**  
**XC105HCUL**  
**XCB7005C.T.P4S.UL**

† FAG Basic Bearing Number is for reference only. All bearings are available exclusively from Barden, and must be ordered using the Barden Basic Bearing Number.

\* = speeds indicated are for spring preloads.



# SPINDLE BEARINGS

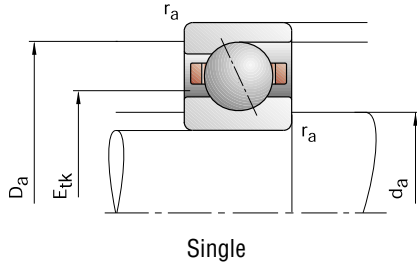

Single

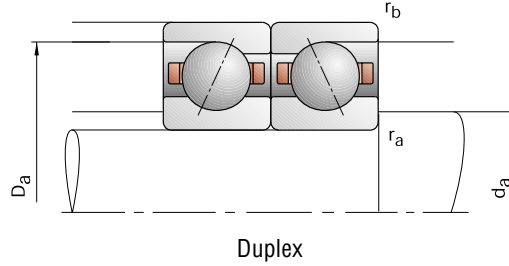

Duplex

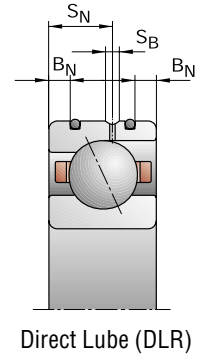

Direct Lube (DLR)

Barden Basic Bearing Number	Dimensions					Shaft & Shoulder Housing Dimensions				DLR Dimensions				Load Ratings			
	d	D	B	r <sub>smin</sub>	r <sub>1smin</sub>	d <sub>a</sub> h12	D <sub>a</sub> H12	r <sub>a</sub> max	r <sub>b</sub> max	B <sub>N</sub>	S <sub>N</sub>	S <sub>B</sub>	E <sub>tk</sub>	C <sub>dyn</sub>	C <sub>0stat</sub>		
	mm															kN	
1806HC	30	42	7	0.30	0.10	33	39	0.3	0.1				34.5	4.40	3.65		
1806HE	30	42	7	0.30	0.10	33	39	0.3	0.1				34.5	4.15	3.40		
C1806HC	30	42	7	0.30	0.10	33	39	0.3	0.1				34.5	3.05	2.55		
C1806HE	30	42	7	0.30	0.10	33	39	0.3	0.1				34.5	2.85	2.40		
1906HC	30	47	9	0.30	0.30	34	43.5	0.3	0.3				36.8	8.65	6.55		
1906HE	30	47	9	0.30	0.30	34	43.5	0.3	0.3				36.8	8.15	6.30		
C1906HC	30	47	9	0.30	0.30	34	43.5	0.3	0.3				36.8	6.00	4.65		
C1906HE	30	47	9	0.30	0.30	34	43.5	0.3	0.3				36.8	5.60	4.40		
XC1906HC	30	47	9	0.30	0.30	34	43.5	0.3	0.3				36.8	13.40	4.65		
XC1906HE	30	47	9	0.30	0.30	34	43.5	0.3	0.3				36.8	12.50	4.40		
ZSB1906C	30	47	9	0.30	0.30	34	43.5	0.3	0.3				36.8	6.40	5.20		
ZSB1906E	30	47	9	0.30	0.30	34	43.5	0.3	0.3				36.8	6.00	4.90		
CZSB1906C	30	47	9	0.30	0.30	34	43.5	0.3	0.3				36.8	4.40	3.65		
CZSB1906E	30	47	9	0.30	0.30	34	43.5	0.3	0.3				36.8	4.15	3.45		
XCZSB1906C	30	47	9	0.30	0.30	34	43.5	0.3	0.3				36.8	9.80	3.65		
XCZSB1906E	30	47	9	0.30	0.30	34	43.5	0.3	0.3				36.8	9.30	3.45		
106HC	30	55	13	1.00	1.00	36	49	1.0	0.3				40.4	15.00	10.20		
106HE	30	55	13	1.00	1.00	36	49	1.0	0.3				40.4	14.30	9.80		
C106HC	30	55	13	1.00	1.00	36	49	1.0	0.3	2.8	7.2	1.4	40.4	10.40	7.20		
C106HE	30	55	13	1.00	1.00	36	49	1.0	0.3	2.8	7.2	1.4	40.4	10.00	6.80		
XC106HC	30	55	13	1.00	1.00	36	49	1.0	0.3	2.8	7.2	1.4	40.4	23.20	7.20		
XC106HE	30	55	13	1.00	1.00	36	49	1.0	0.3	2.8	7.2	1.4	40.4	22.40	6.80		
ZSB106C	30	55	13	1.00	1.00	36	49	1.0	0.3				40.5	8.80	7.10		
ZSB106E	30	55	13	1.00	1.00	36	49	1.0	0.3				40.5	8.30	6.70		
CZSB106C	30	55	13	1.00	1.00	36	49	1.0	0.3	2.8	7.2	1.4	40.5	6.00	4.90		
CZSB106E	30	55	13	1.00	1.00	36	49	1.0	0.3	2.8	7.2	1.4	40.5	5.70	4.65		
XCZSB106C	30	55	13	1.00	1.00	36	49	1.0	0.3	2.8	7.2	1.4	40.5	13.40	4.90		
XCZSB106E	30	55	13	1.00	1.00	36	49	1.0	0.3	2.8	7.2	1.4	40.5	12.70	4.65		
206HC	30	62	16	1.00	1.00	37.5	54.5	1.0	1.0				43.7	23.20	14.60		
206HE	30	62	16	1.00	1.00	37.5	54.5	1.0	1.0				43.7	22.00	14.00		
C206HC	30	62	16	1.00	1.00	37.5	54.5	1.0	1.0				43.7	16.00	10.20		
C206HE	30	62	16	1.00	1.00	37.5	54.5	1.0	1.0				43.7	15.30	9.80		

**Designation examples:**

Barden

FAG

**Sealed design**

106HCRRUL

(B7006C.2RSD.T.P4S.UL)

**Hybrid ceramic design**

C106HCUL

(HCB7006C.T.P4S.UL)



# SPINDLE BEARINGS

## 1800HC/E, 1900HC/E, 100HC/E, 200HC/E, ZSB1900C/E, ZSB100C/E

C: Contact Angle  $\alpha = 15^\circ$  / E: Contact Angle  $\alpha = 25^\circ$

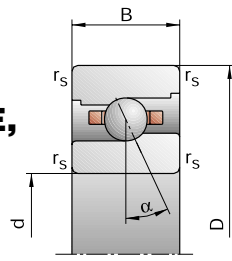

High Speed Design (ZSB)

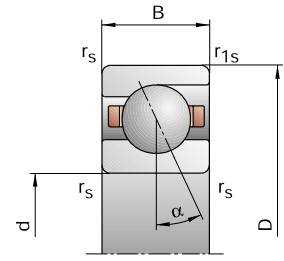

Standard Design

Attainable Speed*		Standard Preload $F_V$ (Force)			Unloading Force $K_{aE}$			Axial Rigidity $S_a$			Sealed Design	Weight	FAG Basic Bearing Number†
Grease	Oil minimal	L	M	H	L	M	H	L	M	H		kg	
min <sup>-1</sup>		N						N/μm					
30000	45000	16	56	129	48	183	456	20.9	36.6	56.0	–	0.03	B71806C.TPA.P4
28000	43000	18	73	189	51	215	578	44.6	75.5	110.9	–	0.03	B71806E.TPA.P4
38000	56000	8	30	75	24	94	251	18.2	30.8	46.9	–	0.03	HCB71806C.TPA.P4
34000	50000	13	48	111	37	141	334	45.1	72.9	100.5	–	0.03	HCB71806E.TPA.P4
28000	43000	42	158	345	131	542	1284	29.5	54.3	82.1	•	0.05	B71906C.T.P4S
26000	40000	40	194	445	117	588	1399	58.7	105.7	148.9	•	0.05	B71906E.T.P4S
36000	53000	14	66	153	42	212	522	21.3	40.2	59.2	•	0.04	HCB71906C.T.P4S
32000	48000	30	86	223	88	257	683	59.9	87.7	125.9	•	0.04	HCB71906E.T.P4S
48000	70000	14	66	153	42	212	522	21.3	40.2	59.2	•	0.04	XCB71906C.T.P4S
40000	60000	30	86	223	88	257	683	59.9	87.7	125.9	•	0.04	XCB71906E.T.P4S
36000	53000	21	64	129	63	203	431	21.1	33.7	46.8	•	0.05	HS71906C.T.P4S
32000	48000	35	105	209	101	310	629	53.1	79.4	103.6	•	0.05	HS71906E.T.P4S
43000	63000	15	45	90	45	141	292	21.0	32.6	43.9	•	0.05	HC71906C.T.P4S
36000	53000	24	72	145	70	213	435	53.0	78.3	101.5	•	0.05	HC71906E.T.P4S
53000	80000	15	45	90	45	141	292	21.0	32.6	43.9	•	0.05	XC71906C.T.P4S
48000	70000	24	72	145	70	213	435	53.0	78.3	101.5	•	0.05	XC71906E.T.P4S
26000	40000	75	260	545	234	885	1998	32.7	57.8	85.1	•	0.11	B7006C.T.P4S
24000	38000	102	397	861	300	1211	2721	74.1	124.1	171.3	•	0.11	B7006E.T.P4S
32000	48000	35	137	297	107	445	1022	27.2	47.7	68.5	•	0.10	HCB7006C.T.P4S
28000	43000	38	193	446	111	580	1377	58.9	106.0	146.6	•	0.10	HCB7006E.T.P4S
43000	60000	35	137	297	107	445	1022	27.2	47.7	68.5	•	0.10	XCB7006C.T.P4S
36000	53000	38	193	446	111	580	1377	58.9	106.0	146.6	•	0.10	XCB7006E.T.P4S
32000	48000	29	88	176	87	280	589	24.2	38.7	53.4	•	0.13	HS7006C.T.P4S
28000	43000	48	143	285	139	422	859	60.8	90.6	118.3	•	0.13	HS7006E.T.P4S
38000	56000	20	61	122	60	190	397	23.8	36.9	50.0	•	0.12	HC7006C.T.P4S
32000	48000	33	99	198	96	293	595	60.5	89.6	115.9	•	0.12	HC7006E.T.P4S
50000	75000	20	61	122	60	190	397	23.8	36.9	50.0	•	0.12	XC7006C.T.P4S
40000	60000	33	99	198	96	293	595	60.5	89.6	115.9	•	0.12	XC7006E.T.P4S
24000	38000	122	412	856	388	1445	3250	42.1	75.5	112.3	•	0.19	B7206C.T.P4S
22000	36000	175	637	1357	517	1967	4361	94.8	157.3	217.9	•	0.19	B7206E.T.P4S
30000	45000	75	268	566	233	902	2040	38.4	67.5	98.3	•	0.17	HCB7206C.T.P4S
26000	40000	100	407	895	295	1243	2820	87.5	148.0	203.6	•	0.17	HCB7206E.T.P4S

**Direct lube design**  
Consult Barden  
(HCB7006EDLR.T.P4S.UL)

**X-life ultra design**  
**XC106HCUL**  
(XCB7006C.T.P4S.UL)

† FAG Basic Bearing Number is for reference only. All bearings are available exclusively from Barden, and must be ordered using the Barden Basic Bearing Number.

\* = speeds indicated are for spring preloads.



# SPINDLE BEARINGS

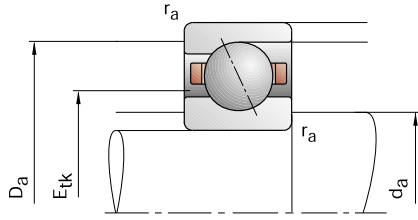

Single

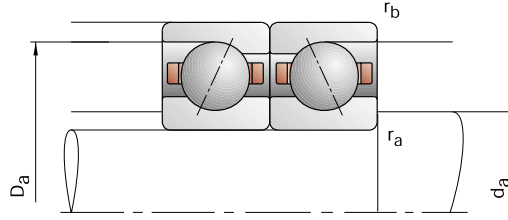

Duplex

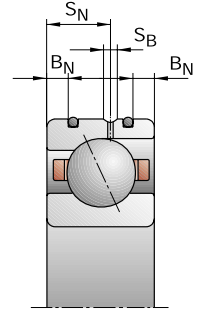

Direct Lube (DLR)

Barden Basic Bearing Number	Dimensions					Shaft & Shoulder Housing Dimensions				DLR Dimensions				Load Ratings			
	d	D	B	r <sub>smin</sub>	r <sub>1smin</sub>	d <sub>a</sub> h12	D <sub>a</sub> H12	r <sub>a</sub> max	r <sub>b</sub> max	B <sub>N</sub>	S <sub>N</sub>	S <sub>B</sub>	E <sub>tk</sub>	C <sub>dyn</sub>	C <sub>0stat</sub>		
	mm															kN	
1807HC	35	47	7	0.30	0.10	38	44	0.3	0.1				39.5	4.65	4.15		
1807HE	35	47	7	0.30	0.10	38	44	0.3	0.1				39.5	4.40	3.80		
C1807HC	35	47	7	0.30	0.10	38	44	0.3	0.1				39.5	3.20	2.85		
C1807HE	35	47	7	0.30	0.10	38	44	0.3	0.1				39.5	3.00	2.65		
1907HC	35	55	10	0.60	0.60	40	51.5	0.6	0.6				44.0	11.80	9.50		
1907HE	35	55	10	0.60	0.60	40	51.5	0.6	0.6				44.0	11.00	9.00		
C1907HC	35	55	10	0.60	0.60	40	51.5	0.6	0.6				44.0	8.15	6.55		
C1907HE	35	55	10	0.60	0.60	40	51.5	0.6	0.6				44.0	7.65	6.30		
XC1907HC	35	55	10	0.60	0.60	40	51.5	0.6	0.6				44.0	18.00	6.55		
XC1907HE	35	55	10	0.60	0.60	40	51.5	0.6	0.6				44.0	17.00	6.30		
ZSB1907C	35	55	10	0.60	0.60	40	51.5	0.6	0.6				43.3	6.95	6.20		
ZSB1907E	35	55	10	0.60	0.60	40	51.5	0.6	0.6				43.3	6.55	5.85		
CZSB1907C	35	55	10	0.60	0.60	40	51.5	0.6	0.6				43.3	4.80	4.40		
CZSB1907E	35	55	10	0.60	0.60	40	51.5	0.6	0.6				43.3	4.50	4.05		
XCZSB1907C	35	55	10	0.60	0.60	40	51.5	0.6	0.6				43.3	10.80	4.40		
XCZSB1907E	35	55	10	0.60	0.60	40	51.5	0.6	0.6				43.3	10.00	4.05		
107HC	35	62	14	1.00	1.00	41	56	1.0	0.3				45.6	19.00	13.70		
107HE	35	62	14	1.00	1.00	41	56	1.0	0.3				45.6	18.30	12.90		
C107HC	35	62	14	1.00	1.00	41	56	1.0	0.3	2.8	8.0	1.4	45.6	13.20	9.50		
C107HE	35	62	14	1.00	1.00	41	56	1.0	0.3	2.8	8.0	1.4	45.6	12.50	9.00		
XC107HC	35	62	14	1.00	1.00	41	56	1.0	0.3	2.8	8.0	1.4	45.6	29.00	9.50		
XC107HE	35	62	14	1.00	1.00	41	56	1.0	0.3	2.8	8.0	1.4	45.6	28.00	9.00		
ZSB107C	35	62	14	1.00	1.00	41	56	1.0	0.3				46.5	9.30	8.30		
ZSB107E	35	62	14	1.00	1.00	41	56	1.0	0.3				46.5	8.80	7.80		
CZSB107C	35	62	14	1.00	1.00	41	56	1.0	0.3	2.8	8.0	1.4	46.5	6.40	5.85		
CZSB107E	35	62	14	1.00	1.00	41	56	1.0	0.3	2.8	8.0	1.4	46.5	6.10	5.40		
XCZSB107C	35	62	14	1.00	1.00	41	56	1.0	0.3	2.8	8.0	1.4	46.5	14.30	5.85		
XCZSB107E	35	62	14	1.00	1.00	41	56	1.0	0.3	2.8	8.0	1.4	46.5	13.70	5.40		
207HC	35	72	17	1.10	1.10	44	63	1.0	1.0				50.7	25.50	18.00		
207HE	35	72	17	1.10	1.10	44	63	1.0	1.0				50.7	24.50	17.00		
C207HC	35	72	17	1.10	1.10	44	63	1.0	1.0				50.7	17.60	8.80		
C207HE	35	72	17	1.10	1.10	44	63	1.0	1.0				50.7	16.60	8.50		

**Designation examples:**

Barden

FAG

**Sealed design**

107HCRRUL

(B7007C.2RSD.T.P4S.UL)

**Hybrid ceramic design**

C107HCUL

(HCB7007C.T.P4S.UL)

# SPINDLE BEARINGS

## 1800HC/E, 1900HC/E, 100HC/E, 200HC/E, ZSB1900C/E, ZSB100C/E

C: Contact Angle  $\alpha = 15^\circ$  / E: Contact Angle  $\alpha = 25^\circ$

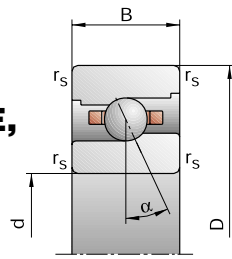

High Speed Design (ZSB)

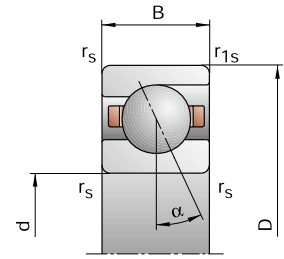

Standard Design

Attainable Speed*		Standard Preload $F_V$ (Force)			Unloading Force $K_{aE}$			Axial Rigidity $S_a$			Sealed Design	Weight	FAG Basic Bearing Number†
Grease	Oil minimal	L	M	H	L	M	H	L	M	H		kg	
min <sup>-1</sup>		N						N/μm					
26000	40000	17	58	135	51	189	473	23.1	39.9	60.7	–	0.03	B71807C.TPA.P4
24000	38000	19	76	197	54	223	601	49.4	82.6	121.4	–	0.03	B71807E.TPA.P4
34000	50000	9	30	78	27	93	259	20.6	32.9	50.9	–	0.03	HCB71807C.TPA.P4
30000	45000	13	48	112	37	141	336	48.8	78.9	108.7	–	0.03	HCB71807E.TPA.P4
24000	38000	61	209	481	190	711	1782	36.3	64.1	99.3	•	0.07	B71907C.T.P4S
22000	36000	61	276	619	178	835	1945	73.5	129.4	180.6	•	0.07	B71907E.T.P4S
32000	48000	21	96	217	63	309	741	26.7	49.7	72.4	•	0.06	HCB71907C.T.P4S
26000	40000	44	127	316	129	380	968	74.1	108.9	154.0	•	0.06	HCB71907E.T.P4S
40000	60000	21	96	217	63	309	741	26.7	49.7	72.4	•	0.06	XCB71907C.T.P4S
34000	50000	44	127	316	129	380	968	74.1	108.9	154.0	•	0.06	XCB71907E.T.P4S
32000	48000	24	71	142	72	224	471	24.8	38.9	53.6	•	0.08	HS71907C.T.P4S
26000	40000	38	115	230	110	339	690	61.4	91.7	119.6	•	0.08	HS71907E.T.P4S
36000	53000	16	49	98	48	152	316	24.0	37.1	50.1	•	0.08	HC71907C.T.P4S
30000	45000	26	79	159	75	233	476	60.5	90.4	117.1	•	0.08	HC71907E.T.P4S
48000	70000	16	49	98	48	152	316	24.0	37.1	50.1	•	0.08	XC71907C.T.P4S
40000	60000	26	79	159	75	233	476	60.5	90.4	117.1	•	0.08	XC71907E.T.P4S
22000	36000	97	333	697	303	1132	2548	38.7	67.8	99.5	•	0.15	B7007C.T.P4S
20000	34000	136	518	1116	400	1577	3525	88.4	146.9	202.1	•	0.15	B7007E.T.P4S
28000	43000	46	177	382	140	574	1312	32.2	56.2	80.5	•	0.13	HCB7007C.T.P4S
24000	38000	54	255	581	159	767	1789	72.4	126.2	173.3	•	0.13	HCB7007E.T.P4S
38000	56000	46	177	382	140	574	1312	32.2	56.2	80.5	•	0.13	XCB7007C.T.P4S
32000	48000	54	255	581	159	767	1789	72.4	126.2	173.3	•	0.13	XCB7007E.T.P4S
28000	43000	32	95	190	96	300	632	27.4	43.1	59.5	•	0.17	HS7007C.T.P4S
24000	38000	51	154	308	147	453	926	67.8	101.5	132.7	•	0.17	HS7007E.T.P4S
34000	50000	22	66	131	66	205	424	26.9	41.3	55.7	•	0.17	HC7007C.T.P4S
28000	43000	36	107	214	105	316	642	68.5	100.6	130.2	•	0.17	HC7007E.T.P4S
43000	63000	22	66	131	66	205	424	26.9	41.3	55.7	•	0.17	XC7007C.T.P4S
36000	53000	36	107	214	105	316	642	68.5	100.6	130.2	•	0.17	XC7007E.T.P4S
20000	34000	136	454	942	427	1555	3475	45.3	79.1	116.0	•	0.28	B7207C.T.P4S
19000	32000	197	714	1521	580	2185	4825	103.9	170.4	234.1	•	0.28	B7207E.T.P4S
26000	40000	66	241	514	202	786	1777	37.9	65.1	93.2	•	0.24	HCB7207C.T.P4S
22000	36000	84	362	804	247	1091	2489	86.9	147.5	201.3	•	0.24	HCB7207E.T.P4S

**Direct lube design**  
Consult Barden  
(HCB7007EDLR.T.P4S.UL)

**X-life ultra design**  
**XC107HCUL**  
(XCB7007C.T.P4S.UL)

† FAG Basic Bearing Number is for reference only. All bearings are available exclusively from Barden, and must be ordered using the Barden Basic Bearing Number.

\* = speeds indicated are for spring preloads.



# SPINDLE BEARINGS

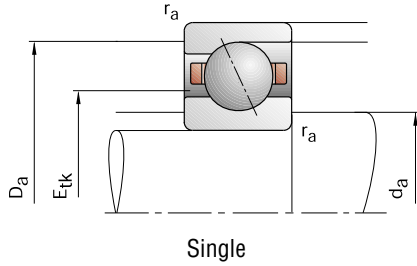

Single

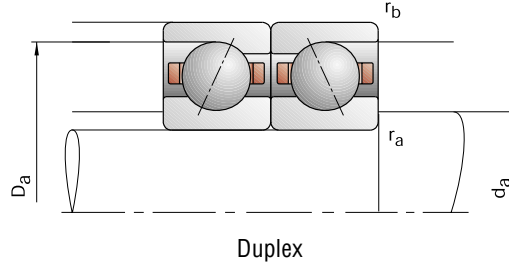

Duplex

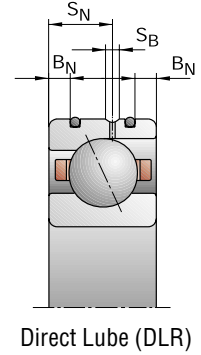

Direct Lube (DLR)

Barden Basic Bearing Number	Dimensions					Shaft & Shoulder Housing Dimensions				DLR Dimensions				Load Ratings			
	d	D	B	r <sub>smin</sub>	r <sub>1smin</sub>	d <sub>a</sub> h12	D <sub>a</sub> H12	r <sub>a</sub> max	r <sub>b</sub> max	B <sub>N</sub>	S <sub>N</sub>	S <sub>B</sub>	E <sub>tk</sub>	C <sub>dyn</sub>	C <sub>0stat</sub>		
	mm															kN	
1808HC	40	52	7	0.30	0.10	43	49	0.3	0.1				44.5	4.80	4.55		
1808HE	40	52	7	0.30	0.10	43	49	0.3	0.1				44.5	4.55	4.25		
C1808HC	40	52	7	0.30	0.10	43	49	0.3	0.1				44.5	3.35	3.15		
C1808HE	40	52	7	0.30	0.10	43	49	0.3	0.1				44.5	3.15	2.90		
1908HC	40	62	12	0.60	0.60	45	58.5	0.6	0.6				49.1	17.60	13.70		
1908HE	40	62	12	0.60	0.60	45	58.5	0.6	0.6				49.1	16.60	13.20		
C1908HC	40	62	12	0.60	0.60	45	58.5	0.6	0.6	2.2	6.6	1.4	49.1	12.20	9.65		
C1908HE	40	62	12	0.60	0.60	45	58.5	0.6	0.6	2.2	6.6	1.4	49.1	11.40	9.15		
XC1908HC	40	62	12	0.60	0.60	45	58.5	0.6	0.6	2.2	6.6	1.4	49.1	27.00	9.65		
XC1908HE	40	62	12	0.60	0.60	45	58.5	0.6	0.6	2.2	6.6	1.4	49.1	25.50	9.15		
ZSB1908C	40	62	12	0.60	0.60	45	58.5	0.6	0.6				49.3	7.20	6.95		
ZSB1908E	40	62	12	0.60	0.60	45	58.5	0.6	0.6				49.3	6.80	6.40		
CZSB1908C	40	62	12	0.60	0.60	45	58.5	0.6	0.6	2.2	6.6	1.4	49.3	5.00	4.80		
CZSB1908E	40	62	12	0.60	0.60	45	58.5	0.6	0.6	2.2	6.6	1.4	49.3	4.75	4.50		
XCZSB1908C	40	62	12	0.60	0.60	45	58.5	0.6	0.6	2.2	6.6	1.4	49.3	11.20	4.80		
XCZSB1908E	40	62	12	0.60	0.60	45	58.5	0.6	0.6	2.2	6.6	1.4	49.3	10.60	4.50		
108HC	40	68	15	1.00	1.00	46	62	1.0	0.3				50.8	20.40	16.00		
108HE	40	68	15	1.00	1.00	46	62	1.0	0.3				50.8	19.60	15.00		
C108HC	40	68	15	1.00	1.00	46	62	1.0	0.3	2.8	8.5	1.4	50.8	14.30	11.00		
C108HE	40	68	15	1.00	1.00	46	62	1.0	0.3	2.8	8.5	1.4	50.8	13.40	10.60		
XC108HC	40	68	15	1.00	1.00	46	62	1.0	0.3	2.8	8.5	1.4	50.8	32.00	11.00		
XC108HE	40	68	15	1.00	1.00	46	62	1.0	0.3	2.8	8.5	1.4	50.8	30.00	10.60		
ZSB108C	40	68	15	1.00	1.00	46	62	1.0	0.3				52.0	10.00	9.30		
ZSB108E	40	68	15	1.00	1.00	46	62	1.0	0.3				52.0	9.30	8.65		
CZSB108C	40	68	15	1.00	1.00	46	62	1.0	0.3	2.8	8.5	1.4	52.0	6.80	6.55		
CZSB108E	40	68	15	1.00	1.00	46	62	1.0	0.3	2.8	8.5	1.4	52.0	6.40	6.10		
XCZSB108C	40	68	15	1.00	1.00	46	62	1.0	0.3	2.8	8.5	1.4	52.0	15.30	6.55		
XCZSB108E	40	68	15	1.00	1.00	46	62	1.0	0.3	2.8	8.5	1.4	52.0	14.30	6.10		
208HC	40	80	18	1.10	1.10	48	72	1.0	1.0				56.7	32.00	22.40		
208HE	40	80	18	1.10	1.10	48	72	1.0	1.0				56.7	30.50	21.60		
C208HC	40	80	18	1.10	1.10	48	72	1.0	1.0				56.7	22.00	15.60		
C208HE	40	80	18	1.10	1.10	48	72	1.0	1.0				56.7	21.20	15.00		

**Designation examples:**

Barden

FAG

**Sealed design**

108HCRRUL

(B7008C.2RSD.T.P4S.UL)

**Hybrid ceramic design**

C108HCUL

(HCB7008C.T.P4S.UL)

# SPINDLE BEARINGS

## 1800HC/E, 1900HC/E, 100HC/E, 200HC/E, ZSB1900C/E, ZSB100C/E

C: Contact Angle  $\alpha = 15^\circ$  / E: Contact Angle  $\alpha = 25^\circ$

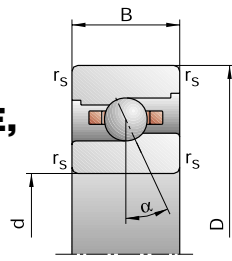

High Speed Design (ZSB)

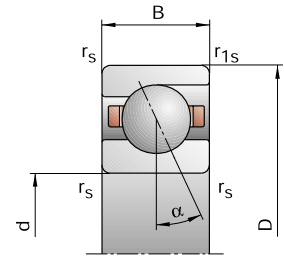

Standard Design

Attainable Speed*		Standard Preload $F_V$ (Force)			Unloading Force $K_{aE}$			Axial Rigidity $S_a$			Sealed Design	Weight	FAG Basic Bearing Number†
Grease	Oil minimal	L	M	H	L	M	H	L	M	H		kg	
min <sup>-1</sup>		N						N/μm					
24000	38000	17	59	138	51	190	481	24.7	42.4	64.9	–	0.03	B71808C.TPA.P4
22000	36000	17	75	199	48	220	604	50.8	88.2	129.8	–	0.03	B71808E.TPA.P4
30000	45000	8	29	77	24	90	253	21.2	34.8	53.5	–	0.03	HCB71808C.TPA.P4
26000	40000	16	47	112	46	138	334	56.9	84.0	115.9	–	0.03	HCB71808E.TPA.P4
22000	36000	85	300	633	265	1019	2315	41.1	72.9	107.4	•	0.11	B71908C.T.P4S
20000	34000	112	450	984	328	1366	3101	91.7	155.3	215.0	•	0.11	B71908E.T.P4S
28000	43000	39	156	341	119	505	1170	33.9	59.8	86.1	•	0.09	HCB71908C.T.P4S
24000	38000	76	222	519	224	666	1596	90.7	133.7	185.4	•	0.09	HCB71908E.T.P4S
36000	53000	39	156	341	119	505	1170	33.9	59.8	86.1	•	0.09	XCB71908C.T.P4S
30000	45000	76	222	519	224	666	1596	90.7	133.7	185.4	•	0.09	XCB71908E.T.P4S
28000	43000	25	74	147	75	233	484	27.0	42.3	57.7	•	0.13	HS71908C.T.P4S
24000	38000	40	120	239	115	352	715	66.9	99.9	130.0	•	0.13	HS71908E.T.P4S
32000	48000	17	51	102	51	158	328	26.4	40.5	54.5	•	0.12	HC71908C.T.P4S
28000	43000	28	83	166	81	244	496	67.0	98.7	127.8	•	0.12	HC71908E.T.P4S
40000	60000	17	51	102	51	158	328	26.4	40.5	54.5	•	0.12	XC71908C.T.P4S
36000	53000	28	83	166	81	244	496	67.0	98.7	127.8	•	0.12	XC71908E.T.P4S
20000	34000	102	353	743	318	1201	2722	43.5	76.9	113.2	•	0.19	B7008C.T.P4S
19000	32000	142	547	1180	417	1665	3728	99.2	165.8	228.5	•	0.19	B7008E.T.P4S
26000	40000	48	187	406	146	607	1397	36.2	63.5	91.3	•	0.17	HCB7008C.T.P4S
22000	36000	55	269	617	161	809	1900	80.3	142.5	196.1	•	0.17	HCB7008E.T.P4S
34000	50000	48	187	406	146	607	1397	36.2	63.5	91.3	•	0.17	XCB7008C.T.P4S
28000	43000	55	269	617	161	809	1900	80.3	142.5	196.1	•	0.17	XCB7008E.T.P4S
26000	40000	34	101	201	102	318	665	30.3	47.5	65.2	•	0.22	HS7008C.T.P4S
22000	36000	54	163	327	156	479	981	75.1	112.0	146.4	•	0.22	HS7008E.T.P4S
30000	45000	23	70	139	69	217	448	29.6	45.6	61.2	•	0.20	HC7008C.T.P4S
26000	40000	38	113	225	110	333	673	75.1	110.9	143.1	•	0.20	HC7008E.T.P4S
38000	56000	23	70	139	69	217	448	29.6	45.6	61.2	•	0.20	XC7008C.T.P4S
34000	50000	38	113	225	110	333	673	75.1	110.9	143.1	•	0.20	XC7008E.T.P4S
18000	30000	176	584	1204	554	2007	4451	49.6	86.5	126.5	•	0.37	B7208C.T.P4S
17000	28000	259	912	1925	764	2796	6112	114.2	185.5	253.8	•	0.37	B7208E.T.P4S
24000	38000	89	314	662	273	1027	2296	42.1	71.5	102.0	•	0.33	HCB7208C.T.P4S
20000	34000	118	477	1045	347	1441	3235	97.6	162.5	220.5	•	0.33	HCB7208E.T.P4S

**Direct lube design**  
Consult Barden  
(HCB7008EDLR.T.P4S.UL)

**X-life ultra design**  
**XC108HCUL**  
(XCB7008C.T.P4S.UL)

† FAG Basic Bearing Number is for reference only. All bearings are available exclusively from Barden, and must be ordered using the Barden Basic Bearing Number.

\* = speeds indicated are for spring preloads.



# SPINDLE BEARINGS

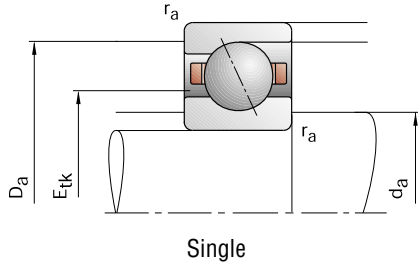

Single

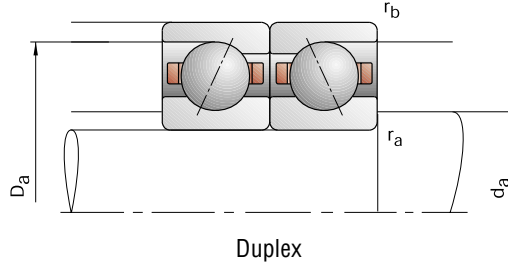

Duplex

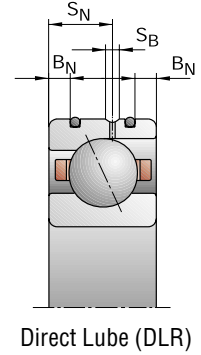

Direct Lube (DLR)

Barden Basic Bearing Number	Dimensions					Shaft & Shoulder Housing Dimensions				DLR Dimensions				Load Ratings	
	d	D	B	r <sub>smin</sub>	r <sub>1smin</sub>	d <sub>a</sub> h12	D <sub>a</sub> H12	r <sub>a</sub> max	r <sub>b</sub> max	B <sub>N</sub>	S <sub>N</sub>	S <sub>B</sub>	E <sub>tk</sub>	C <sub>dyn</sub>	C <sub>0stat</sub>
mm															
1809HC	45	58	7	0.30	0.10	48	55.5	0.3	0.1				49.6	7.20	6.95
1809HE	45	58	7	0.30	0.10	48	55.5	0.3	0.1				49.6	6.80	6.40
C1809HC	45	58	7	0.30	0.10	48	55.5	0.3	0.1				49.6	5.00	4.80
C1809HE	45	58	7	0.30	0.10	48	55.5	0.3	0.1				49.6	4.75	4.50
1909HC	45	68	12	0.60	0.60	50	63.5	0.6	0.6				54.4	18.60	15.60
1909HE	45	68	12	0.60	0.60	50	63.5	0.6	0.6				54.4	17.60	15.00
C1909HC	45	68	12	0.60	0.60	50	63.5	0.6	0.6	2.2	6.6	1.4	54.4	12.90	10.80
C1909HE	45	68	12	0.60	0.60	50	63.5	0.6	0.6	2.2	6.6	1.4	54.4	12.20	10.40
XC1909HC	45	68	12	0.60	0.60	50	63.5	0.6	0.6	2.2	6.6	1.4	54.4	29.00	10.80
XC1909HE	45	68	12	0.60	0.60	50	63.5	0.6	0.6	2.2	6.6	1.4	54.4	27.00	10.40
ZSB1909C	45	68	12	0.60	0.60	50	63.5	0.6	0.6				54.5	10.00	9.65
ZSB1909E	45	68	12	0.60	0.60	50	63.5	0.6	0.6				54.5	9.50	9.00
CZSB1909C	45	68	12	0.60	0.60	50	63.5	0.6	0.6	2.2	6.6	1.4	54.5	6.95	6.70
CZSB1909E	45	68	12	0.60	0.60	50	63.5	0.6	0.6	2.2	6.6	1.4	54.5	6.55	6.30
XCZSB1909C	45	68	12	0.60	0.60	50	63.5	0.6	0.6	2.2	6.6	1.4	54.5	15.60	6.70
XCZSB1909E	45	68	12	0.60	0.60	50	63.5	0.6	0.6	2.2	6.6	1.4	54.5	14.60	6.30
109HC	45	75	16	1.00	1.00	51	69	1.0	0.3				56.2	27.50	21.20
109HE	45	75	16	1.00	1.00	51	69	1.0	0.3				56.2	26.50	20.00
C109HC	45	75	16	1.00	1.00	51	69	1.0	0.3	3.4	9.3	1.4	56.2	19.00	14.60
C109HE	45	75	16	1.00	1.00	51	69	1.0	0.3	3.4	9.3	1.4	56.2	18.00	14.00
XC109HC	45	75	16	1.00	1.00	51	69	1.0	0.3	3.4	9.3	1.4	56.2	42.50	14.60
XC109HE	45	75	16	1.00	1.00	51	69	1.0	0.3	3.4	9.3	1.4	56.2	40.00	14.00
ZSB109C	45	75	16	1.00	1.00	51	69	1.0	0.3				57.7	12.90	12.20
ZSB109E	45	75	16	1.00	1.00	51	69	1.0	0.3				57.7	12.20	11.40
CZSB109C	45	75	16	1.00	1.00	51	69	1.0	0.3	3.4	9.3	1.4	57.7	8.80	8.50
CZSB109E	45	75	16	1.00	1.00	51	69	1.0	0.3	3.4	9.3	1.4	57.7	8.30	8.00
XCZSB109C	45	75	16	1.00	1.00	51	69	1.0	0.3	3.4	9.3	1.4	57.7	19.60	8.50
XCZSB109E	45	75	16	1.00	1.00	51	69	1.0	0.3	3.4	9.3	1.4	57.7	18.60	8.00
209HC	45	85	19	1.10	1.10	52.5	78	1.0	1.0				61.8	33.50	24.50
209HE	45	85	19	1.10	1.10	52.5	78	1.0	1.0				61.8	32.00	23.60
C209HC	45	85	19	1.10	1.10	52.5	78	1.0	1.0				61.8	23.20	12.20
C209HE	45	85	19	1.10	1.10	52.5	78	1.0	1.0				61.8	22.00	11.60

**Designation examples:**

Barden

FAG

**Sealed design**

109HCRRUL

(B7009C.2RSD.T.P4S.UL)

**Hybrid ceramic design**

C109HCUL

(HCB7009C.T.P4S.UL)



# SPINDLE BEARINGS

## 1800HC/E, 1900HC/E, 100HC/E, 200HC/E, ZSB1900C/E, ZSB100C/E

C: Contact Angle  $\alpha = 15^\circ$  / E: Contact Angle  $\alpha = 25^\circ$

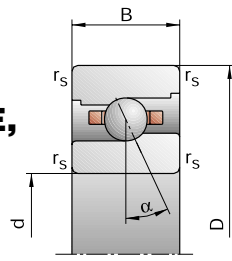

High Speed Design (ZSB)

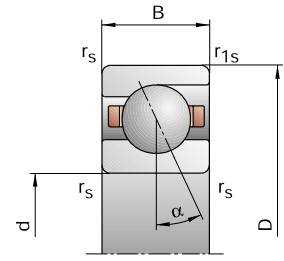

Standard Design

Attainable Speed*		Standard Preload $F_V$ (Force)			Unloading Force $K_{aE}$			Axial Rigidity $S_a$			Sealed Design	Weight	FAG Basic Bearing Number†
Grease	Oil minimal	L	M	H	L	M	H	L	M	H		kg	
min <sup>-1</sup>		N						N/μm					
22000	36000	22	98	221	66	318	774	28.2	53.6	80.7	–	0.04	B71809C.TPA.P4
19000	32000	35	133	328	100	391	999	69.0	113.1	162.6	–	0.04	B71809E.TPA.P4
28000	43000	15	53	130	45	165	431	27.5	45.3	68.2	–	0.04	HCB71809C.TPA.P4
24000	38000	24	85	193	69	249	580	68.6	107.9	147.7	–	0.04	HCB71809E.TPA.P4
19000	32000	89	315	667	276	1064	2425	44.4	78.7	116.0	•	0.13	B71909C.T.P4S
18000	30000	116	473	1038	339	1433	3261	99.2	168.8	233.6	•	0.13	B71909E.T.P4S
24000	38000	41	164	360	124	529	1229	36.6	64.8	93.3	•	0.11	HCB71909C.T.P4S
22000	36000	79	230	541	232	689	1659	98.2	144.8	200.8	•	0.11	HCB71909E.T.P4S
32000	48000	41	164	360	124	529	1229	36.6	64.8	93.3	•	0.11	XCB71909C.T.P4S
28000	43000	79	230	541	232	689	1659	98.2	144.8	200.8	•	0.11	XCB71909E.T.P4S
24000	38000	34	103	205	102	323	677	31.0	48.8	67.1	•	0.14	HS71909C.T.P4S
22000	36000	55	166	331	159	487	992	77.5	115.4	150.5	•	0.14	HS71909E.T.P4S
28000	43000	24	71	142	72	220	457	30.8	46.9	63.1	•	0.13	HC71909C.T.P4S
24000	38000	38	115	230	110	339	688	77.0	114.4	147.8	•	0.13	HC71909E.T.P4S
38000	56000	24	71	142	72	220	457	30.8	46.9	63.1	•	0.13	XC71909C.T.P4S
32000	48000	38	115	230	110	339	688	77.0	114.4	147.8	•	0.13	XC71909E.T.P4S
18000	30000	145	490	1019	453	1669	3734	50.2	87.8	128.6	•	0.23	B7009C.T.P4S
17000	28000	209	768	1638	614	2344	5176	115.5	190.0	260.6	•	0.23	B7009E.T.P4S
24000	38000	72	264	562	220	858	1935	42.5	73.0	104.2	•	0.20	HCB7009C.T.P4S
20000	34000	90	393	876	264	1182	2706	97.0	165.3	225.7	•	0.20	HCB7009E.T.P4S
30000	45000	72	264	562	220	858	1935	42.5	73.0	104.2	•	0.20	XCB7009C.T.P4S
26000	40000	90	393	876	264	1182	2706	97.0	165.3	225.7	•	0.20	XCB7009E.T.P4S
24000	38000	44	131	263	131	412	870	34.3	54.2	74.9	•	0.27	HS7009C.T.P4S
20000	34000	71	214	428	204	628	1283	85.7	128.1	167.4	•	0.27	HS7009E.T.P4S
26000	40000	30	91	182	89	282	586	33.4	52.1	70.2	•	0.26	HC7009C.T.P4S
24000	38000	49	147	294	142	431	876	85.5	126.1	163.3	•	0.26	HC7009E.T.P4S
34000	50000	30	91	182	89	282	586	33.4	52.1	70.2	•	0.26	XC7009C.T.P4S
30000	45000	49	147	294	142	431	876	85.5	126.1	163.3	•	0.26	XC7009E.T.P4S
17000	28000	184	607	1252	578	2078	4609	52.7	91.5	133.6	•	0.41	B7209C.T.P4S
15000	24000	270	955	2016	796	2916	6388	121.6	197.3	270.0	•	0.41	B7209E.T.P4S
22000	36000	93	329	694	285	1074	2400	44.8	76.1	108.3	•	0.34	HCB7209C.T.P4S
18000	30000	121	493	1083	356	1487	3346	103.4	172.2	233.8	•	0.34	HCB7209E.T.P4S

**Direct lube design**  
Consult Barden  
(HCB7009EDLR.T.P4S.UL)

**X-life ultra design**  
**XC109HCUL**  
(XCB7009C.T.P4S.UL)

† FAG Basic Bearing Number is for reference only. All bearings are available exclusively from Barden, and must be ordered using the Barden Basic Bearing Number.

\* = speeds indicated are for spring preloads.



# SPINDLE BEARINGS

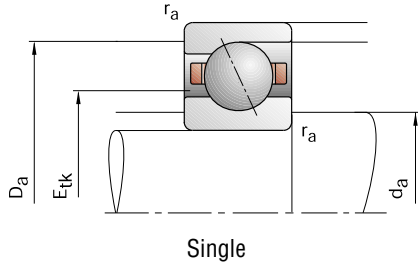

Single

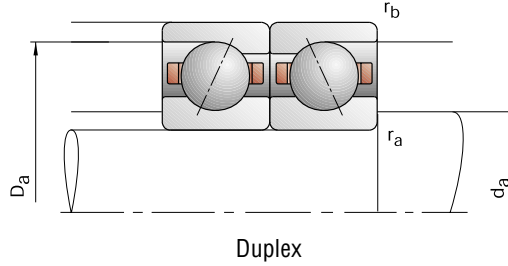

Duplex

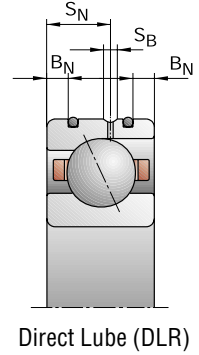

Direct Lube (DLR)

Barden Basic Bearing Number	Dimensions					Shaft & Shoulder Housing Dimensions				DLR Dimensions				Load Ratings			
	d	D	B	r <sub>smin</sub>	r <sub>1smin</sub>	d <sub>a</sub> h12	D <sub>a</sub> H12	r <sub>a</sub> max	r <sub>b</sub> max	B <sub>N</sub>	S <sub>N</sub>	S <sub>B</sub>	E <sub>tk</sub>	C <sub>dyn</sub>	C <sub>0stat</sub>		
	mm															kN	
1810HC	50	65	7	0.30	0.10	54	61.5	0.3	0.1				55.6	7.35	7.35		
1810HE	50	65	7	0.30	0.10	54	61.5	0.3	0.1				55.6	6.95	6.80		
C1810HC	50	65	7	0.30	0.10	54	61.5	0.3	0.1				55.6	5.10	5.10		
C1810HE	50	65	7	0.30	0.10	54	61.5	0.3	0.1				55.6	4.80	4.75		
1910HC	50	72	12	0.60	0.60	55	67.5	0.6	0.6				58.9	19.00	16.60		
1910HE	50	72	12	0.60	0.60	55	67.5	0.6	0.6				58.9	18.00	15.60		
C1910HC	50	72	12	0.60	0.60	55	67.5	0.6	0.6	2.2	6.6	1.4	58.9	13.20	11.60		
C1910HE	50	72	12	0.60	0.60	55	67.5	0.6	0.6	2.2	6.6	1.4	58.9	12.20	11.00		
XC1910HC	50	72	12	0.60	0.60	55	67.5	0.6	0.6	2.2	6.6	1.4	58.9	29.00	11.60		
XC1910HE	50	72	12	0.60	0.60	55	67.5	0.6	0.6	2.2	6.6	1.4	58.9	27.00	11.00		
ZSB1910C	50	72	12	0.60	0.60	55	67.5	0.6	0.6				59.0	10.40	10.20		
ZSB1910E	50	72	12	0.60	0.60	55	67.5	0.6	0.6				59.0	9.80	9.65		
CZSB1910C	50	72	12	0.60	0.60	55	67.5	0.6	0.6	2.2	6.6	1.4	59.0	7.10	7.20		
CZSB1910E	50	72	12	0.60	0.60	55	67.5	0.6	0.6	2.2	6.6	1.4	59.0	6.70	6.70		
XCZSB1910C	50	72	12	0.60	0.60	55	67.5	0.6	0.6	2.2	6.6	1.4	59.0	16.00	7.20		
XCZSB1910E	50	72	12	0.60	0.60	55	67.5	0.6	0.6	2.2	6.6	1.4	59.0	15.00	6.70		
110HC	50	80	16	1.00	1.00	56	74	1.0	0.3				61.2	28.50	22.80		
110HE	50	80	16	1.00	1.00	56	74	1.0	0.3				61.2	27.00	21.60		
C110HC	50	80	16	1.00	1.00	56	74	1.0	0.3	3.4	9.3	1.4	61.2	19.60	16.00		
C110HE	50	80	16	1.00	1.00	56	74	1.0	0.3	3.4	9.3	1.4	61.2	18.60	15.30		
XC110HC	50	80	16	1.00	1.00	56	74	1.0	0.3	3.4	9.3	1.4	61.2	44.00	16.00		
XC110HE	50	80	16	1.00	1.00	56	74	1.0	0.3	3.4	9.3	1.4	61.2	41.50	15.30		
ZSB110C	50	80	16	1.00	1.00	56	74	1.0	0.3				62.7	13.40	13.20		
ZSB110E	50	80	16	1.00	1.00	56	74	1.0	0.3				62.7	12.50	12.20		
CZSB110C	50	80	16	1.00	1.00	56	74	1.0	0.3	3.4	9.3	1.4	62.7	9.15	9.15		
CZSB110E	50	80	16	1.00	1.00	56	74	1.0	0.3	3.4	9.3	1.4	62.7	8.65	8.50		
XCZSB110C	50	80	16	1.00	1.00	56	74	1.0	0.3	3.4	9.3	1.4	62.7	20.40	9.15		
XCZSB110E	50	80	16	1.00	1.00	56	74	1.0	0.3	3.4	9.3	1.4	62.7	19.30	8.50		
210HC	50	90	20	1.10	1.10	57	83	1.0	1.0				66.2	43.00	31.50		
210HE	50	90	20	1.10	1.10	57	83	1.0	1.0				66.2	40.50	30.50		
C210HC	50	90	20	1.10	1.10	57	83	1.0	1.0				66.2	30.00	22.00		
C210HE	50	90	20	1.10	1.10	57	83	1.0	1.0				66.2	28.00	21.20		

**Designation examples:**

Barden

FAG

**Sealed design**

110HCRRUL

(B7010C.2RSD.T.P4S.UL)

**Hybrid ceramic design**

C110HCUL

(HCB7010C.T.P4S.UL)

# SPINDLE BEARINGS

## 1800HC/E, 1900HC/E, 100HC/E, 200HC/E, ZSB1900C/E, ZSB100C/E

C: Contact Angle  $\alpha = 15^\circ$  / E: Contact Angle  $\alpha = 25^\circ$

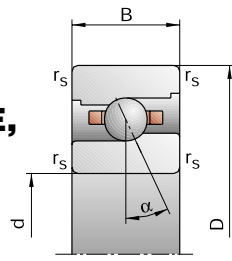

High Speed Design (ZSB)

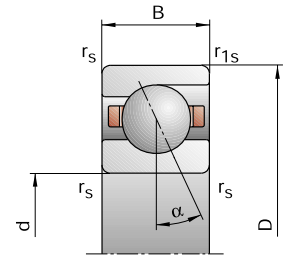

Standard Design

Attainable Speed*		Standard Preload $F_V$ (Force)			Unloading Force $K_{aE}$			Axial Rigidity $S_a$			Sealed Design	Weight	FAG Basic Bearing Number†
Grease	Oil minimal	L	M	H	L	M	H	L	M	H		kg	
min <sup>-1</sup>		N											
		N/μm											
19000	32000	21	99	224	62	320	780	28.5	55.9	84.0	–	0.05	B71810C.TPA.P4
17000	28000	34	133	332	97	390	1011	71.4	117.9	170.2	–	0.05	B71810E.TPA.P4
24000	38000	14	52	129	41	162	425	27.5	46.9	70.4	–	0.05	HCB71810C.TPA.P4
20000	34000	25	86	195	72	252	585	72.9	113.3	154.7	–	0.05	HCB71810E.TPA.P4
18000	30000	90	321	679	279	1081	2459	46.0	81.4	119.7	•	0.13	B71910C.T.P4S
16000	26000	118	482	1059	345	1458	3322	103.1	175.1	242.3	•	0.13	B71910E.T.P4S
22000	36000	41	166	366	124	534	1246	37.8	66.9	96.4	•	0.11	HCB71910C.T.P4S
20000	34000	79	232	549	232	694	1681	101.4	149.7	208.0	•	0.11	HCB71910E.T.P4S
30000	43000	41	166	366	124	534	1246	37.8	66.9	96.4	•	0.11	XCB71910C.T.P4S
26000	40000	79	232	549	232	694	1681	101.4	149.7	208.0	•	0.11	XCB71910E.T.P4S
22000	36000	35	105	209	105	329	687	32.8	51.4	70.2	•	0.15	HS71910C.T.P4S
20000	34000	58	173	345	167	507	1033	82.4	122.5	159.7	•	0.15	HS71910E.T.P4S
26000	40000	24	72	145	71	222	465	31.8	49.1	66.2	•	0.14	HC71910C.T.P4S
22000	36000	39	117	235	113	344	702	81.5	120.3	155.8	•	0.14	HC71910E.T.P4S
34000	50000	24	72	145	71	222	465	31.8	49.1	66.2	•	0.14	XC71910C.T.P4S
30000	45000	39	117	235	113	344	702	81.5	120.3	155.8	•	0.14	XC71910E.T.P4S
17000	28000	150	507	1054	468	1722	3850	52.7	92.0	134.7	•	0.25	B7010C.T.P4S
15000	24000	211	779	1663	619	2372	5240	120.4	198.1	271.5	•	0.25	B7010E.T.P4S
22000	36000	74	275	586	226	892	2014	44.6	76.9	109.7	•	0.21	HCB7010C.T.P4S
18000	30000	89	397	889	261	1192	2741	100.5	172.3	235.5	•	0.21	HCB7010E.T.P4S
28000	43000	74	275	586	226	892	2014	44.6	76.9	109.7	•	0.21	XCB7010C.T.P4S
24000	38000	89	397	889	261	1192	2741	100.5	172.3	235.5	•	0.21	XCB7010E.T.P4S
22000	36000	46	137	273	137	430	900	36.7	57.7	79.4	•	0.29	HS7010C.T.P4S
18000	30000	74	222	444	212	650	1329	91.2	136.2	178.0	•	0.29	HS7010E.T.P4S
24000	38000	32	95	190	95	294	610	36.0	55.4	74.7	•	0.27	HC7010C.T.P4S
22000	36000	51	154	308	148	451	917	91.3	134.6	174.3	•	0.27	HC7010E.T.P4S
32000	48000	32	95	190	95	294	610	36.0	55.4	74.7	•	0.27	XC7010C.T.P4S
28000	43000	51	154	308	148	451	917	91.3	134.6	174.3	•	0.27	XC7010E.T.P4S
16000	26000	242	792	1631	761	2708	6004	60.4	104.4	152.5	•	0.46	B7210C.T.P4S
14000	22000	355	1230	2583	1045	3757	8185	139.2	224.3	306.1	•	0.46	B7210E.T.P4S
20000	34000	123	425	893	377	1384	3080	51.4	86.5	122.8	•	0.39	HCB7210C.T.P4S
17000	28000	169	657	1425	498	1985	4409	121.0	198.4	268.1	•	0.39	HCB7210E.T.P4S

**Direct lube design**  
Consult Barden  
(HCB7010EDLR.T.P4S.UL)

**X-life ultra design**  
**XC110HCUL**  
(XCB7010C.T.P4S.UL)

† FAG Basic Bearing Number is for reference only. All bearings are available exclusively from Barden, and must be ordered using the Barden Basic Bearing Number.

\* = speeds indicated are for spring preloads.



# SPINDLE BEARINGS

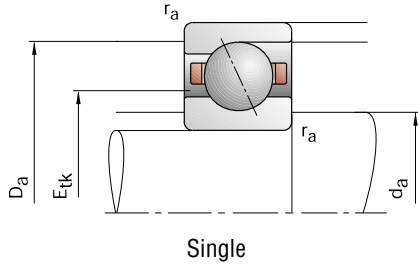

Single

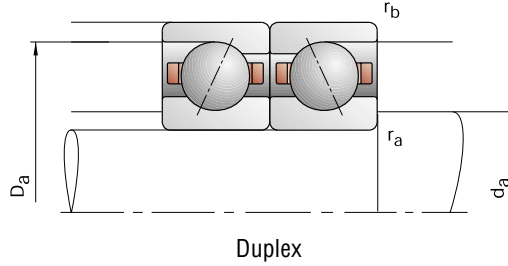

Duplex

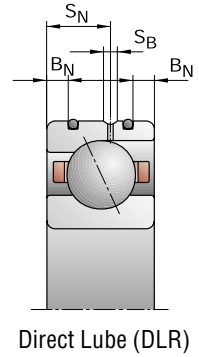

Direct Lube (DLR)

Barden Basic Bearing Number	Dimensions					Shaft & Shoulder Housing Dimensions				DLR Dimensions				Load Ratings			
	d	D	B	r <sub>smin</sub>	r <sub>1smin</sub>	d <sub>a</sub> h12	D <sub>a</sub> H12	r <sub>a</sub> max	r <sub>b</sub> max	B <sub>N</sub>	S <sub>N</sub>	S <sub>B</sub>	E <sub>tk</sub>	C <sub>dyn</sub>	C <sub>0stat</sub>		
	mm															kN	
1811HC	55	72	9	0.30	0.10	59	68.5	0.3	0.1				61.2	10.20	10.20		
1811HE	55	72	9	0.30	0.10	59	68.5	0.3	0.1				61.2	9.65	9.50		
C1811HC	55	72	9	0.30	0.10	59	68.5	0.3	0.1				61.2	7.10	7.20		
C1811HE	55	72	9	0.30	0.10	59	68.5	0.3	0.1				61.2	6.70	6.70		
1911HC	55	80	13	1.00	1.00	60	75.5	0.6	0.6				65.1	22.80	20.40		
1911HE	55	80	13	1.00	1.00	60	75.5	0.6	0.6				65.1	21.60	19.30		
C1911HC	55	80	13	1.00	1.00	60	75.5	0.6	0.6	2.8	7.2	1.4	65.1	16.00	14.30		
C1911HE	55	80	13	1.00	1.00	60	75.5	0.6	0.6	2.8	7.2	1.4	65.1	15.00	13.40		
XC1911HC	55	80	13	1.00	1.00	60	75.5	0.6	0.6	2.8	7.2	1.4	65.1	35.50	14.30		
XC1911HE	55	80	13	1.00	1.00	60	75.5	0.6	0.6	2.8	7.2	1.4	65.1	33.50	13.40		
ZSB1911C	55	80	13	1.00	1.00	60	75.5	0.6	0.6				65.2	13.40	13.70		
ZSB1911E	55	80	13	1.00	1.00	60	75.5	0.6	0.6				65.2	12.70	12.70		
CZSB1911C	55	80	13	1.00	1.00	60	75.5	0.6	0.6	2.8	7.2	1.4	65.2	9.30	9.50		
CZSB1911E	55	80	13	1.00	1.00	60	75.5	0.6	0.6	2.8	7.2	1.4	65.2	8.80	8.80		
XCZSB1911C	55	80	13	1.00	1.00	60	75.5	0.6	0.6	2.8	7.2	1.4	65.2	20.80	9.50		
XCZSB1911E	55	80	13	1.00	1.00	60	75.5	0.6	0.6	2.8	7.2	1.4	65.2	19.60	8.80		
111HC	55	90	18	1.10	1.10	62	83	1.0	0.6				68.1	38.00	31.00		
111HE	55	90	18	1.10	1.10	62	83	1.0	0.6				68.1	36.00	29.00		
C111HC	55	90	18	1.10	1.10	62	83	1.0	0.6	4.3	9.7	1.4	68.1	26.00	21.60		
C111HE	55	90	18	1.10	1.10	62	83	1.0	0.6	4.3	9.7	1.4	68.1	25.00	20.40		
XC111HC	55	90	18	1.10	1.10	62	83	1.0	0.6	4.3	9.7	1.4	68.1	58.50	21.60		
XC111HE	55	90	18	1.10	1.10	62	83	1.0	0.6	4.3	9.7	1.4	68.1	56.00	20.40		
ZSB111C	55	90	18	1.10	1.10	62	83	1.0	0.6				69.7	18.60	19.00		
ZSB111E	55	90	18	1.10	1.10	62	83	1.0	0.6				69.7	17.60	17.60		
CZSB111C	55	90	18	1.10	1.10	62	83	1.0	0.6	4.3	9.7	1.4	69.7	12.90	13.20		
CZSB111E	55	90	18	1.10	1.10	62	83	1.0	0.6	4.3	9.7	1.4	69.7	12.20	12.20		
XCZSB111C	55	90	18	1.10	1.10	62	83	1.0	0.6	4.3	9.7	1.4	69.7	29.00	13.20		
XCZSB111E	55	90	18	1.10	1.10	62	83	1.0	0.6	4.3	9.7	1.4	69.7	27.00	12.20		
211HC	55	100	21	1.50	1.50	63	92	1.5	1.5				73.7	46.50	37.50		
211HE	55	100	21	1.50	1.50	63	92	1.5	1.5				73.7	44.00	35.50		
C211HC	55	100	21	1.50	1.50	63	92	1.5	1.5				73.7	32.00	18.30		
C211HE	55	100	21	1.50	1.50	63	92	1.5	1.5				73.7	30.50	17.60		

**Designation examples:**

Barden

FAG

**Sealed design**

111HCRRUL

(B7011C.2RSD.T.P4S.UL)

**Hybrid ceramic design**

C111HCUL

(HCB7011C.T.P4S.UL)

# SPINDLE BEARINGS

## 1800HC/E, 1900HC/E, 100HC/E, 200HC/E, ZSB1900C/E, ZSB100C/E

C: Contact Angle  $\alpha = 15^\circ$  / E: Contact Angle  $\alpha = 25^\circ$

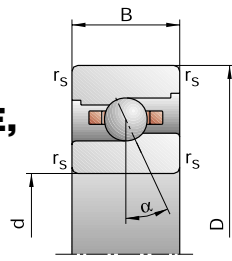

High Speed Design (ZSB)

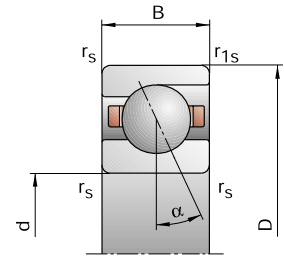

Standard Design

Attainable Speed*		Standard Preload $F_V$ (Force)			Unloading Force $K_{aE}$			Axial Rigidity $S_a$			Sealed Design	Weight	FAG Basic Bearing Number†
Grease	Oil minimal	L	M	H	L	M	H	L	M	H		kg	
min <sup>-1</sup>		N											
		N/ $\mu$ m											
17000	28000	35	147	326	105	477	1139	35.9	66.8	99.7	–	0.08	B71811C.TPA.P4
16000	26000	57	206	491	163	607	1497	88.4	142.6	202.4	–	0.08	B71811E.TPA.P4
22000	36000	17	82	194	50	257	645	30.5	57.4	84.9	–	0.08	HCB71811C.TPA.P4
19000	32000	30	98	269	86	286	805	80.0	122.1	178.6	–	0.08	HCB71811E.TPA.P4
16000	26000	112	391	825	347	1317	2985	51.2	90.0	131.9	•	0.18	B71911C.T.P4S
15000	24000	149	592	1287	436	1791	4036	115.5	194.2	267.4	•	0.18	B71911E.T.P4S
20000	34000	51	204	444	154	656	1510	42.1	74.2	106.2	•	0.15	HCB71911C.T.P4S
18000	30000	58	298	693	170	893	2125	94.2	168.8	233.2	•	0.15	HCB71911E.T.P4S
26000	40000	51	204	444	154	656	1510	42.1	74.2	106.2	•	0.15	XCB71911C.T.P4S
24000	38000	58	298	693	170	893	2125	94.2	168.8	233.2	•	0.15	XCB71911E.T.P4S
20000	34000	46	139	279	137	436	919	37.5	59.4	81.8	•	0.20	HS71911C.T.P4S
18000	30000	75	225	451	215	659	1349	93.9	140.1	183.1	•	0.20	HS71911E.T.P4S
24000	38000	32	96	193	95	296	619	36.8	56.8	76.7	•	0.19	HC71911C.T.P4S
20000	34000	52	156	313	150	457	931	93.6	138.5	179.3	•	0.19	HC71911E.T.P4S
32000	48000	32	96	193	95	296	619	36.8	56.8	76.7	•	0.19	XC71911C.T.P4S
26000	40000	52	156	313	150	457	931	93.6	138.5	179.3	•	0.19	XC71911E.T.P4S
15000	24000	207	687	1424	647	2336	5203	61.9	107.2	156.5	•	0.37	B7011C.T.P4S
14000	22000	298	1066	2257	876	3243	7117	142.4	231.6	316.4	•	0.37	B7011E.T.P4S
19000	32000	104	373	789	317	1212	2713	52.6	89.6	127.3	•	0.32	HCB7011C.T.P4S
17000	28000	134	553	1219	394	1664	3754	121.6	202.9	275.4	•	0.32	HCB7011E.T.P4S
26000	40000	104	373	789	317	1212	2713	52.6	89.6	127.3	•	0.32	XCB7011C.T.P4S
22000	36000	134	553	1219	394	1664	3754	121.6	202.9	275.4	•	0.32	XCB7011E.T.P4S
19000	32000	64	192	383	191	603	1264	42.6	67.2	92.4	•	0.43	HS7011C.T.P4S
17000	28000	105	315	630	301	922	1883	106.6	159.2	207.9	•	0.43	HS7011E.T.P4S
22000	36000	45	134	268	134	415	861	42.1	64.7	87.1	•	0.40	HC7011C.T.P4S
19000	32000	73	219	437	211	643	1303	106.7	157.8	203.9	•	0.40	HC7011E.T.P4S
28000	43000	45	134	268	134	415	861	42.1	64.7	87.1	•	0.40	XC7011C.T.P4S
24000	38000	73	219	437	211	643	1303	106.7	157.8	203.9	•	0.40	XC7011E.T.P4S
14000	22000	261	849	1750	816	2885	6395	67.3	115.6	168.4	•	0.61	B7211C.T.P4S
13000	20000	381	1331	2797	1120	4055	8833	155.5	250.7	341.7	•	0.61	B7211E.T.P4S
18000	30000	134	466	979	410	1513	3363	57.7	97.0	137.5	•	0.51	HCB7211C.T.P4S
15000	24000	178	702	1527	524	2111	4710	134.4	220.8	298.5	•	0.51	HCB7211E.T.P4S

**Direct lube design**  
Consult Barden  
(HCB7011EDLR.T.P4S.UL)

**X-life ultra design**  
**XC111HCUL**  
(XCB7011C.T.P4S.UL)

† FAG Basic Bearing Number is for reference only. All bearings are available exclusively from Barden, and must be ordered using the Barden Basic Bearing Number.

\* = speeds indicated are for spring preloads.



# SPINDLE BEARINGS

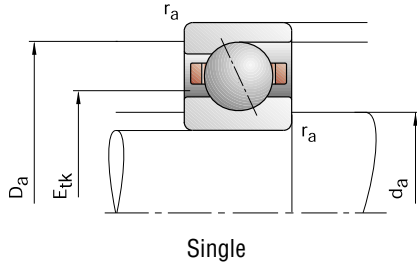

Single

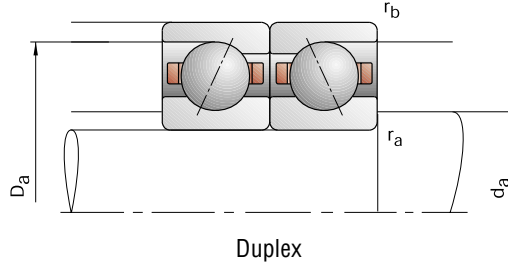

Duplex

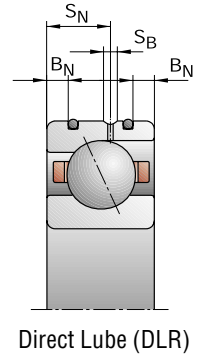

Direct Lube (DLR)

Barden Basic Bearing Number	Dimensions					Shaft & Shoulder Housing Dimensions				DLR Dimensions				Load Ratings	
	d	D	B	r <sub>smin</sub>	r <sub>1smin</sub>	d <sub>a</sub> h12	D <sub>a</sub> H12	r <sub>a</sub> max	r <sub>b</sub> max	B <sub>N</sub>	S <sub>N</sub>	S <sub>B</sub>	E <sub>tk</sub>	C <sub>dyn</sub>	C <sub>0stat</sub>
mm															
1812HC	60	78	10	0.30	0.10	63	74.5	0.3	0.1				66.3	13.20	13.20
1812HE	60	78	10	0.30	0.10	63	74.5	0.3	0.1				66.3	12.20	12.20
C1812HC	60	78	10	0.30	0.10	63	74.5	0.3	0.1				66.3	9.00	9.15
C1812HE	60	78	10	0.30	0.10	63	74.5	0.3	0.1				66.3	8.50	8.50
1912HC	60	85	13	1.00	1.00	65	80.5	0.6	0.6				70.1	24.00	22.80
1912HE	60	85	13	1.00	1.00	65	80.5	0.6	0.6				70.1	22.80	21.60
C1912HC	60	85	13	1.00	1.00	65	80.5	0.6	0.6	2.8	7.2	1.4	70.1	16.60	16.00
C1912HE	60	85	13	1.00	1.00	65	80.5	0.6	0.6	2.8	7.2	1.4	70.1	15.60	15.00
XC1912HC	60	85	13	1.00	1.00	65	80.5	0.6	0.6	2.8	7.2	1.4	70.1	37.50	16.00
XC1912HE	60	85	13	1.00	1.00	65	80.5	0.6	0.6	2.8	7.2	1.4	70.1	34.50	15.00
ZSB1912C	60	85	13	1.00	1.00	65	80.5	0.6	0.6				70.2	14.00	14.60
ZSB1912E	60	85	13	1.00	1.00	65	80.5	0.6	0.6				70.2	13.20	13.40
CZSB1912C	60	85	13	1.00	1.00	65	80.5	0.6	0.6	2.8	7.2	1.4	70.2	9.65	10.00
CZSB1912E	60	85	13	1.00	1.00	65	80.5	0.6	0.6	2.8	7.2	1.4	70.2	9.00	9.50
XCZSB1912C	60	85	13	1.00	1.00	65	80.5	0.6	0.6	2.8	7.2	1.4	70.2	21.60	10.00
XCZSB1912E	60	85	13	1.00	1.00	65	80.5	0.6	0.6	2.8	7.2	1.4	70.2	20.00	9.50
112HC	60	95	18	1.10	1.10	67	88	1.0	0.6				73.1	39.00	33.50
112HE	60	95	18	1.10	1.10	67	88	1.0	0.6				73.1	36.50	31.50
C112HC	60	95	18	1.10	1.10	67	88	1.0	0.6	4.3	9.7	1.4	73.1	27.00	23.20
C112HE	60	95	18	1.10	1.10	67	88	1.0	0.6	4.3	9.7	1.4	73.1	25.50	22.00
XC112HC	60	95	18	1.10	1.10	67	88	1.0	0.6	4.3	9.7	1.4	73.1	60.00	23.20
XC112HE	60	95	18	1.10	1.10	67	88	1.0	0.6	4.3	9.7	1.4	73.1	57.00	22.00
ZSB112C	60	95	18	1.10	1.10	67	88	1.0	0.6				74.7	19.30	20.00
ZSB112E	60	95	18	1.10	1.10	67	88	1.0	0.6				74.7	18.30	19.00
CZSB112C	60	95	18	1.10	1.10	67	88	1.0	0.6	4.3	9.7	1.4	74.7	13.40	14.00
CZSB112E	60	95	18	1.10	1.10	67	88	1.0	0.6	4.3	9.7	1.4	74.7	12.70	13.20
XCZSB112C	60	95	18	1.10	1.10	67	88	1.0	0.6	4.3	9.7	1.4	74.7	30.00	14.00
XCZSB112E	60	95	18	1.10	1.10	67	88	1.0	0.6	4.3	9.7	1.4	74.7	28.50	13.20
212HC	60	110	22	1.50	1.50	69.5	101.5	1.5	1.5				81.2	55.00	44.00
212HE	60	110	22	1.50	1.50	69.5	101.5	1.5	1.5				81.2	52.00	42.50
C212HC	60	110	22	1.50	1.50	69.5	101.5	1.5	1.5				81.2	38.00	30.50
C212HE	60	110	22	1.50	1.50	69.5	101.5	1.5	1.5				81.2	36.00	29.00

**Designation examples:**

Barden

FAG

**Sealed design**

112HCRRUL

(B7012C.2RSD.T.P4S.UL)

**Hybrid ceramic design**

C112HCUL

(HCB7012C.T.P4S.UL)



# SPINDLE BEARINGS

## 1800HC/E, 1900HC/E, 100HC/E, 200HC/E, ZSB1900C/E, ZSB100C/E

C: Contact Angle  $\alpha = 15^\circ$  / E: Contact Angle  $\alpha = 25^\circ$

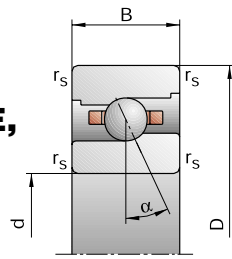

High Speed Design (ZSB)

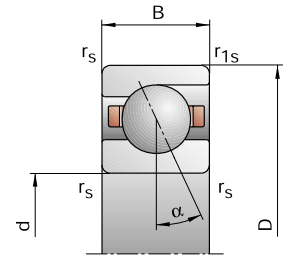

Standard Design

Attainable Speed*		Standard Preload $F_V$ (Force)			Unloading Force $K_{aE}$			Axial Rigidity $S_a$			Sealed Design	Weight	FAG Basic Bearing Number†
Grease	Oil minimal	L	M	H	L	M	H	L	M	H		kg	
min <sup>-1</sup>		N						N/μm					
16000	26000	51	200	435	153	654	1530	41.0	75.1	111.3	–	0.10	B71812C.TPA.P4
14000	22000	80	280	649	229	826	1985	99.6	159.2	223.9	–	0.10	B71812E.TPA.P4
20000	34000	24	112	258	71	352	860	34.6	64.3	94.4	–	0.10	HCB71812C.TPA.P4
17000	28000	41	145	370	118	424	1111	89.5	140.4	200.4	–	0.10	HCB71812E.TPA.P4
15000	24000	117	410	866	362	1376	3119	55.0	96.5	141.2	•	0.19	B71912C.T.P4S
14000	22000	156	622	1353	455	1879	4234	124.4	209.2	287.9	•	0.19	B71912E.T.P4S
19000	32000	54	215	470	163	690	1590	45.5	79.9	114.3	•	0.16	HCB71912C.T.P4S
17000	28000	57	302	707	167	903	2162	99.4	179.6	248.3	•	0.16	HCB71912E.T.P4S
26000	40000	54	215	470	163	690	1590	45.5	79.9	114.3	•	0.16	XCB71912C.T.P4S
22000	36000	57	302	707	167	903	2162	99.4	179.6	248.3	•	0.16	XCB71912E.T.P4S
19000	32000	48	145	289	143	454	949	39.8	62.8	86.2	•	0.21	HS71912C.T.P4S
17000	28000	78	235	469	224	688	1401	99.7	148.7	193.8	•	0.21	HS71912E.T.P4S
22000	36000	34	101	201	101	312	643	39.4	60.5	81.1	•	0.19	HC71912C.T.P4S
19000	32000	53	160	320	153	468	951	98.7	146.0	188.8	•	0.19	HC71912E.T.P4S
28000	43000	34	101	201	101	312	643	39.4	60.5	81.1	•	0.19	XC71912C.T.P4S
24000	38000	53	160	320	153	468	951	98.7	146.0	188.8	•	0.19	XC71912E.T.P4S
14000	22000	211	704	1459	658	2387	5310	64.5	111.7	162.8	•	0.40	B7012C.T.P4S
13000	20000	299	1075	2281	878	3263	7173	147.9	240.4	328.4	•	0.40	B7012E.T.P4S
18000	30000	105	378	801	320	1224	2743	54.7	93.0	132.0	•	0.34	HCB7012C.T.P4S
15000	24000	137	572	1263	402	1720	3885	127.0	213.0	289.0	•	0.34	HCB7012E.T.P4S
24000	38000	105	378	801	320	1224	2743	54.7	93.0	132.0	•	0.34	XCB7012C.T.P4S
20000	34000	137	572	1263	402	1720	3885	127.0	213.0	289.0	•	0.34	XCB7012E.T.P4S
18000	30000	67	201	402	200	630	1323	45.4	71.4	98.2	•	0.46	HS7012C.T.P4S
15000	24000	107	322	644	307	941	1921	112.7	168.1	219.3	•	0.46	HS7012E.T.P4S
20000	34000	46	139	279	136	429	895	44.2	68.5	92.4	•	0.43	HC7012C.T.P4S
18000	30000	75	225	451	217	660	1343	113.2	167.1	216.1	•	0.43	HC7012E.T.P4S
28000	43000	46	139	279	136	429	895	44.2	68.5	92.4	•	0.43	XC7012C.T.P4S
24000	38000	75	225	451	217	660	1343	113.2	167.1	216.1	•	0.43	XC7012E.T.P4S
13000	20000	315	1022	2100	986	3479	7697	71.4	122.8	178.8	•	0.80	B7212C.T.P4S
12000	19000	467	1599	3333	1374	4877	10509	165.9	265.8	360.8	•	0.80	B7212E.T.P4S
16000	26000	162	557	1164	496	1811	4002	61.3	102.7	145.2	•	0.70	HCB7212C.T.P4S
14000	22000	229	867	1866	674	2612	5767	145.8	236.5	318.7	•	0.70	HCB7212E.T.P4S

### Direct lube design

Consult Barden  
(HCB7012EDLR.T.P4S.UL)

### X-life ultra design

**XC112HCUL**  
(XCB7012C.T.P4S.UL)

† FAG Basic Bearing Number is for reference only. All bearings are available exclusively from Barden, and must be ordered using the Barden Basic Bearing Number.

\* = speeds indicated are for spring preloads.



# SPINDLE BEARINGS

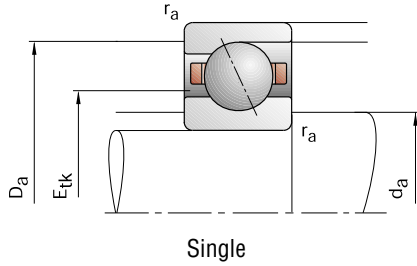

Single

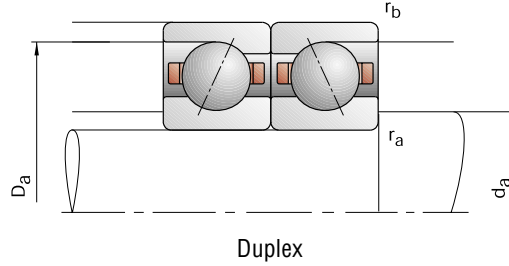

Duplex

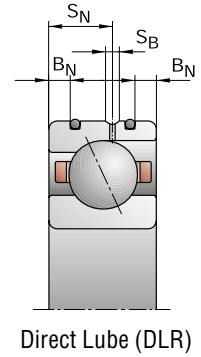

Direct Lube (DLR)

Barden Basic Bearing Number	Dimensions					Shaft & Shoulder Housing Dimensions				DLR Dimensions				Load Ratings			
	d	D	B	r <sub>smin</sub>	r <sub>1smin</sub>	d <sub>a</sub> h12	D <sub>a</sub> H12	r <sub>a</sub> max	r <sub>b</sub> max	B <sub>N</sub>	S <sub>N</sub>	S <sub>B</sub>	E <sub>tk</sub>	C <sub>dyn</sub>	C <sub>0stat</sub>		
	mm															kN	
1813HC	65	85	10	0.60	0.30	69	80.5	0.6	0.3				72.3	13.40	14.00		
1813HE	65	85	10	0.60	0.30	69	80.5	0.6	0.3				72.3	12.70	12.90		
C1813HC	65	85	10	0.60	0.30	69	80.5	0.6	0.3				72.3	9.30	9.80		
C1813HE	65	85	10	0.60	0.30	69	80.5	0.6	0.3				72.3	8.80	9.15		
1913HC	65	90	13	1.00	1.00	70	85.5	0.6	0.6				75.1	24.50	24.00		
1913HE	65	90	13	1.00	1.00	70	85.5	0.6	0.6				75.1	22.80	22.40		
C1913HC	65	90	13	1.00	1.00	70	85.5	0.6	0.6	2.8	7.2	1.4	75.1	17.00	16.60		
C1913HE	65	90	13	1.00	1.00	70	85.5	0.6	0.6	2.8	7.2	1.4	75.1	16.00	16.00		
XC1913HC	65	90	13	1.00	1.00	70	85.5	0.6	0.6	2.8	7.2	1.4	75.1	38.00	16.60		
XC1913HE	65	90	13	1.00	1.00	70	85.5	0.6	0.6	2.8	7.2	1.4	75.1	35.50	16.00		
ZSB1913C	65	90	13	1.00	1.00	70	85.5	0.6	0.6				75.2	14.30	15.30		
ZSB1913E	65	90	13	1.00	1.00	70	85.5	0.6	0.6				75.2	13.40	14.30		
CZSB1913C	65	90	13	1.00	1.00	70	85.5	0.6	0.6	2.8	7.2	1.4	75.2	9.80	10.80		
CZSB1913E	65	90	13	1.00	1.00	70	85.5	0.6	0.6	2.8	7.2	1.4	75.2	9.30	10.00		
XCZSB1913C	65	90	13	1.00	1.00	70	85.5	0.6	0.6	2.8	7.2	1.4	75.2	22.00	10.80		
XCZSB1913E	65	90	13	1.00	1.00	70	85.5	0.6	0.6	2.8	7.2	1.4	75.2	20.80	10.00		
113HC	65	100	18	1.10	1.10	72	93	1.0	0.6				78.1	40.00	35.50		
113HE	65	100	18	1.10	1.10	72	93	1.0	0.6				78.1	38.00	33.50		
C113HC	65	100	18	1.10	1.10	72	93	1.0	0.6	4.0	10.4	1.4	78.1	27.50	24.50		
C113HE	65	100	18	1.10	1.10	72	93	1.0	0.6	4.0	10.4	1.4	78.1	26.00	23.60		
XC113HC	65	100	18	1.10	1.10	72	93	1.0	0.6	4.0	10.4	1.4	78.1	61.00	24.50		
XC113HE	65	100	18	1.10	1.10	72	93	1.0	0.6	4.0	10.4	1.4	78.1	58.50	23.60		
ZSB113C	65	100	18	1.10	1.10	72	93	1.0	0.6				79.7	20.00	21.60		
ZSB113E	65	100	18	1.10	1.10	72	93	1.0	0.6				79.7	19.00	20.00		
CZSB113C	65	100	18	1.10	1.10	72	93	1.0	0.6	4.0	10.4	1.4	79.7	13.70	15.00		
CZSB113E	65	100	18	1.10	1.10	72	93	1.0	0.6	4.0	10.4	1.4	79.7	12.90	14.00		
XCZSB113C	65	100	18	1.10	1.10	72	93	1.0	0.6	4.0	10.4	1.4	79.7	30.50	15.00		
XCZSB113E	65	100	18	1.10	1.10	72	93	1.0	0.6	4.0	10.4	1.4	79.7	28.50	14.00		
213HC	65	120	23	1.50	1.50	75.5	109.5	1.5	1.5				88.2	57.00	48.00		
213HE	65	120	23	1.50	1.50	75.5	109.5	1.5	1.5				88.2	54.00	45.50		
C213HC	65	120	23	1.50	1.50	75.5	109.5	1.5	1.5				88.2	40.00	23.60		
C213HE	65	120	23	1.50	1.50	75.5	109.5	1.5	1.5				88.2	37.50	22.40		

**Designation examples:**

Barden

FAG

**Sealed design**

113HCRRUL

(B7013C.2RSD.T.P4S.UL)

**Hybrid ceramic design**

C113HCUL

(HCB7013C.T.P4S.UL)

# SPINDLE BEARINGS

## 1800HC/E, 1900HC/E, 100HC/E, 200HC/E, ZSB1900C/E, ZSB100C/E

C: Contact Angle  $\alpha = 15^\circ$  / E: Contact Angle  $\alpha = 25^\circ$

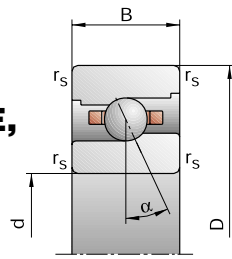

High Speed Design (ZSB)

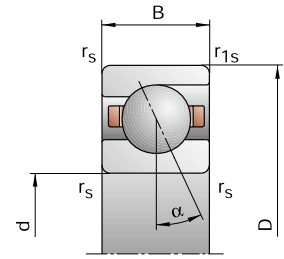

Standard Design

Attainable Speed*		Standard Preload $F_V$ (Force)			Unloading Force $K_{aE}$			Axial Rigidity $S_a$			Sealed Design	Weight	FAG Basic Bearing Number†
Grease	Oil minimal	L	M	H	L	M	H	L	M	H		kg	
min <sup>-1</sup>		N						N/μm					
15000	24000	51	201	440	154	660	1554	43.6	79.9	118.6	–	0.13	B71813C.TPA.P4
13000	20000	82	289	673	236	857	2070	106.8	171.0	241.1	–	0.13	B71813E.TPA.P4
19000	32000	24	116	267	71	366	895	36.6	69.1	101.6	–	0.13	HCB71813C.TPA.P4
16000	26000	42	149	384	121	438	1160	95.5	150.5	215.8	–	0.13	HCB71813E.TPA.P4
14000	22000	118	417	883	364	1396	3172	56.5	99.4	145.6	•	0.20	B71913C.T.P4S
13000	20000	153	617	1348	447	1860	4207	127.1	214.0	294.5	•	0.20	B71913E.T.P4S
18000	30000	55	219	479	166	702	1617	47.1	82.6	117.9	•	0.17	HCB71913C.T.P4S
15000	24000	57	307	721	167	918	2203	102.3	185.7	256.8	•	0.17	HCB71913E.T.P4S
24000	38000	55	219	479	166	702	1617	47.1	82.6	117.9	•	0.17	XCB71913C.T.P4S
20000	34000	57	307	721	167	918	2203	102.3	185.7	256.8	•	0.17	XCB71913E.T.P4S
18000	30000	49	147	295	145	459	965	41.6	65.6	90.0	•	0.23	HS71913C.T.P4S
15000	24000	80	239	478	229	698	1426	104.6	155.7	203.1	•	0.23	HS71913E.T.P4S
20000	34000	34	103	205	101	317	654	41.1	63.3	84.9	•	0.21	HC71913C.T.P4S
18000	30000	55	166	331	159	486	983	104.4	154.4	199.1	•	0.21	HC71913E.T.P4S
26000	43000	34	103	205	101	317	654	41.1	63.3	84.9	•	0.21	XC71913C.T.P4S
24000	38000	55	166	331	159	486	983	104.4	154.4	199.1	•	0.21	XC71913E.T.P4S
13000	20000	216	720	1495	672	2433	5422	67.1	116.1	169.1	•	0.42	B7013C.T.P4S
12000	19000	310	1118	2372	910	3391	7452	155.1	252.3	344.4	•	0.42	B7013E.T.P4S
17000	28000	109	391	830	332	1264	2837	57.4	97.3	138.1	•	0.36	HCB7013C.T.P4S
15000	24000	137	579	1281	402	1739	3934	131.6	221.3	300.2	•	0.36	HCB7013E.T.P4S
22000	36000	109	391	830	332	1264	2837	57.4	97.3	138.1	•	0.36	XCB7013C.T.P4S
19000	32000	137	579	1281	402	1739	3934	131.6	221.3	300.2	•	0.36	XCB7013E.T.P4S
17000	28000	70	209	418	208	654	1373	48.0	75.5	103.8	•	0.48	HS7013C.T.P4S
15000	24000	112	336	672	321	981	2002	119.7	178.3	232.5	•	0.48	HS7013E.T.P4S
20000	34000	47	142	284	139	438	907	46.6	72.0	96.7	•	0.45	HC7013C.T.P4S
17000	28000	77	230	460	222	674	1367	119.2	176.0	227.1	•	0.45	HC7013E.T.P4S
26000	40000	47	142	284	139	438	907	46.6	72.0	96.7	•	0.45	XC7013C.T.P4S
22000	36000	77	230	460	222	674	1367	119.2	176.0	227.1	•	0.45	XC7013E.T.P4S
12000	19000	325	1051	2163	1015	3565	7874	75.1	128.6	186.9	•	1.02	B7213C.T.P4S
11000	18000	482	1656	3455	1417	5043	10873	174.9	280.1	380.1	•	1.02	B7213E.T.P4S
15000	24000	170	580	1213	520	1882	4161	64.9	108.3	153.1	•	0.88	HCB7213C.T.P4S
13000	20000	234	892	1918	688	2684	5918	153.2	248.9	334.9	•	0.88	HCB7213E.T.P4S

**Direct lube design**  
Consult Barden  
(HCB7013EDLR.T.P4S.UL)

**X-life ultra design**  
**XC113HCUL**  
(XCB7013C.T.P4S.UL)

† FAG Basic Bearing Number is for reference only. All bearings are available exclusively from Barden, and must be ordered using the Barden Basic Bearing Number.

\* = speeds indicated are for spring preloads.



# SPINDLE BEARINGS

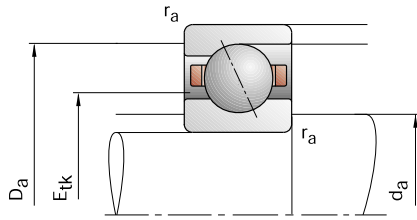

Single

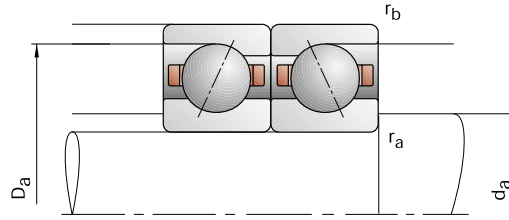

Duplex

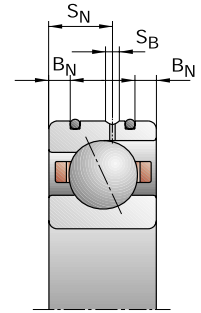

Direct Lube (DLR)

Barden Basic Bearing Number	Dimensions					Shaft & Shoulder Housing Dimensions				DLR Dimensions				Load Ratings	
	d	D	B	r <sub>smin</sub>	r <sub>1smin</sub>	d <sub>a</sub> h12	D <sub>a</sub> H12	r <sub>a</sub> max	r <sub>b</sub> max	B <sub>N</sub>	S <sub>N</sub>	S <sub>B</sub>	E <sub>tk</sub>	C <sub>dyn</sub>	C <sub>0stat</sub>
mm															
1814HC	70	90	10	0.60	0.30	74	85.5	0.6	0.3				77.3	14.00	15.00
1814HE	70	90	10	0.60	0.30	74	85.5	0.6	0.3				77.3	12.90	13.70
C1814HC	70	90	10	0.60	0.30	74	85.5	0.6	0.3				77.3	9.50	10.40
C1814HE	70	90	10	0.60	0.30	74	85.5	0.6	0.3				77.3	9.50	9.65
1914HC	70	100	16	1.00	1.00	76	94.5	0.6	0.6				82.2	33.50	32.50
1914HE	70	100	16	1.00	1.00	76	94.5	0.6	0.6				82.2	31.50	31.00
C1914HC	70	100	16	1.00	1.00	76	94.5	0.6	0.6	3.1	9.3	1.4	82.2	23.20	22.80
C1914HE	70	100	16	1.00	1.00	76	94.5	0.6	0.6	3.1	9.3	1.4	82.2	22.00	21.60
XC1914HC	70	100	16	1.00	1.00	76	94.5	0.6	0.6	3.1	9.3	1.4	82.2	52.00	22.80
XC1914HE	70	100	16	1.00	1.00	76	94.5	0.6	0.6	3.1	9.3	1.4	82.2	49.00	21.60
ZSB1914C	70	100	16	1.00	1.00	76	94.5	0.6	0.6				82.3	18.30	20.00
ZSB1914E	70	100	16	1.00	1.00	76	94.5	0.6	0.6				82.3	17.30	18.60
CZSB1914C	70	100	16	1.00	1.00	76	94.5	0.6	0.6	3.1	9.3	1.4	82.3	12.70	14.00
CZSB1914E	70	100	16	1.00	1.00	76	94.5	0.6	0.6	3.1	9.3	1.4	82.3	12.00	13.20
XCZSB1914C	70	100	16	1.00	1.00	76	94.5	0.6	0.6	3.1	9.3	1.4	82.3	28.50	14.00
XCZSB1914E	70	100	16	1.00	1.00	76	94.5	0.6	0.6	3.1	9.3	1.4	82.3	27.00	13.20
114HC	70	110	20	1.10	1.10	77	102	1.0	0.6				85.0	50.00	43.00
114HE	70	110	20	1.10	1.10	77	102	1.0	0.6				85.0	46.50	41.50
C114HC	70	110	20	1.10	1.10	77	102	1.0	0.6	4.0	11.6	1.4	85.0	34.00	30.00
C114HE	70	110	20	1.10	1.10	77	102	1.0	0.6	4.0	11.6	1.4	85.0	32.50	29.00
XC114HC	70	110	20	1.10	1.10	77	102	1.0	0.6	4.0	11.6	1.4	85.0	76.50	30.00
XC114HE	70	110	20	1.10	1.10	77	102	1.0	0.6	4.0	11.6	1.4	85.0	72.00	29.00
ZSB114C	70	110	20	1.10	1.10	77	102	1.0	0.6				86.7	26.00	28.00
ZSB114E	70	110	20	1.10	1.10	77	102	1.0	0.6				86.7	24.50	26.00
CZSB114C	70	110	20	1.10	1.10	77	102	1.0	0.6	4.0	11.6	1.4	86.7	18.00	19.60
CZSB114E	70	110	20	1.10	1.10	77	102	1.0	0.6	4.0	11.6	1.4	86.7	17.00	18.30
XCZSB114C	70	110	20	1.10	1.10	77	102	1.0	0.6	4.0	11.6	1.4	86.7	40.00	19.60
XCZSB114E	70	110	20	1.10	1.10	77	102	1.0	0.6	4.0	11.6	1.4	86.7	38.00	18.30
214HC	70	125	24	1.50	1.50	80	115	1.5	1.5				92.7	69.50	58.50
214HE	70	125	24	1.50	1.50	80	115	1.5	1.5				92.7	65.50	56.00
C214HC	70	125	24	1.50	1.50	80	115	1.5	1.5				92.7	48.00	40.50
C214HE	70	125	24	1.50	1.50	80	115	1.5	1.5				92.7	45.50	39.00

**Designation examples:**

Barden

FAG

**Sealed design**

114HCRRUL

(B7014C.2RSD.T.P4S.UL)

**Hybrid ceramic design**

C114HCUL

(HCB7014C.T.P4S.UL)

# SPINDLE BEARINGS

## 1800HC/E, 1900HC/E, 100HC/E, 200HC/E, ZSB1900C/E, ZSB100C/E

C: Contact Angle  $\alpha = 15^\circ$  / E: Contact Angle  $\alpha = 25^\circ$

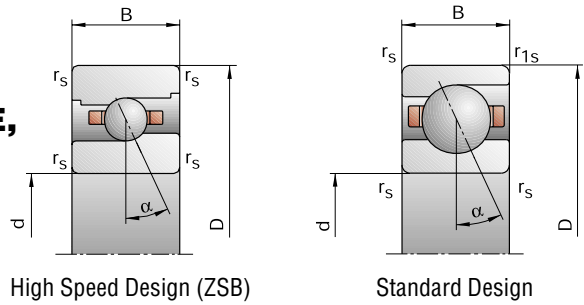

High Speed Design (ZSB)

Standard Design

Attainable Speed*		Standard Preload $F_V$ (Force)			Unloading Force $K_{aE}$			Axial Rigidity $S_a$			Sealed Design	Weight	FAG Basic Bearing Number†
Grease	Oil minimal	L	M	H	L	M	H	L	M	H		kg	
min <sup>-1</sup>		N						N/μm					
14000	22000	53	210	459	160	688	1617	46.1	84.4	125.2	–	0.14	B71814C.TPA.P4
13000	20000	81	289	678	233	855	2079	111.0	178.1	251.3	–	0.14	B71814E.TPA.P4
18000	30000	24	120	277	71	378	927	38.2	72.9	107.1	–	0.14	HCB71814C.TPA.P4
15000	24000	40	147	387	115	431	1166	97.9	156.1	225.3	–	0.14	HCB71814E.TPA.P4
13000	20000	172	588	1230	532	1970	4418	66.5	115.5	168.2	•	0.33	B71914C.T.P4S
12000	19000	234	890	1917	684	2691	5984	151.6	250.6	342.8	•	0.33	B71914E.T.P4S
16000	26000	82	311	671	248	997	2271	55.7	96.0	136.7	•	0.28	HCB71914C.T.P4S
14000	22000	96	452	1026	281	1351	3143	125.8	218.6	299.0	•	0.28	HCB71914E.T.P4S
22000	36000	82	311	671	248	997	2271	55.7	96.0	136.7	•	0.28	XCB71914C.T.P4S
18000	30000	96	452	1026	281	1351	3143	125.8	218.6	299.0	•	0.28	XCB71914E.T.P4S
16000	26000	64	192	383	190	600	1254	47.6	75.0	102.6	•	0.37	HS71914C.T.P4S
14000	22000	103	308	616	295	898	1833	119.0	176.9	230.7	•	0.37	HS71914E.T.P4S
19000	32000	44	131	263	131	403	839	46.9	71.5	96.3	•	0.35	HC71914C.T.P4S
16000	26000	71	214	428	205	626	1271	118.8	175.4	226.7	•	0.35	HC71914E.T.P4S
24000	40000	44	131	263	131	403	839	46.9	71.5	96.3	•	0.35	XC71914C.T.P4S
22000	36000	71	214	428	205	626	1271	118.8	175.4	226.7	•	0.35	XC71914E.T.P4S
12000	19000	278	915	1888	866	3095	6864	73.9	127.3	185.1	•	0.59	B7014C.T.P4S
11000	18000	398	1397	2945	1167	4242	9262	170.1	274.3	373.5	•	0.59	B7014E.T.P4S
16000	26000	140	492	1036	427	1590	3538	63.0	106.1	150.1	•	0.50	HCB7014C.T.P4S
13000	20000	184	736	1609	541	2208	4948	146.7	241.9	327.1	•	0.50	HCB7014E.T.P4S
20000	34000	140	492	1036	427	1590	3538	63.0	106.1	150.1	•	0.50	XCB7014C.T.P4S
17000	28000	184	736	1609	541	2208	4948	146.7	241.9	327.1	•	0.50	XCB7014E.T.P4S
16000	26000	89	268	536	265	837	1757	52.5	82.6	113.5	•	0.67	HS7014C.T.P4S
13000	20000	146	437	874	419	1277	2608	131.9	196.4	256.2	•	0.67	HS7014E.T.P4S
18000	30000	63	188	375	187	579	1202	52.0	79.8	107.4	•	0.63	HC7014C.T.P4S
15000	24000	101	304	607	292	892	1807	131.8	194.9	251.5	•	0.63	HC7014E.T.P4S
24000	38000	63	188	375	187	579	1202	52.0	79.8	107.4	•	0.63	XC7014C.T.P4S
20000	34000	101	304	607	292	892	1807	131.8	194.9	251.5	•	0.63	XC7014E.T.P4S
11000	18000	404	1301	2664	1264	4419	9712	83.8	143.2	207.6	•	1.12	B7214C.T.P4S
10000	17000	600	2030	4233	1765	6187	13319	194.9	310.5	421.0	•	1.12	B7214E.T.P4S
14000	22000	208	708	1477	635	2298	5066	71.8	119.8	169.0	•	0.96	HCB7214C.T.P4S
12000	19000	295	1101	2350	868	3315	7237	171.5	276.5	370.8	•	0.96	HCB7214E.T.P4S

### Direct lube design

Consult Barden  
(HCB7014EDLR.T.P4S.UL)

### X-life ultra design

**XC114HCUL**  
(XCB7014C.T.P4S.UL)

† FAG Basic Bearing Number is for reference only. All bearings are available exclusively from Barden, and must be ordered using the Barden Basic Bearing Number.

\* = speeds indicated are for spring preloads.



# SPINDLE BEARINGS

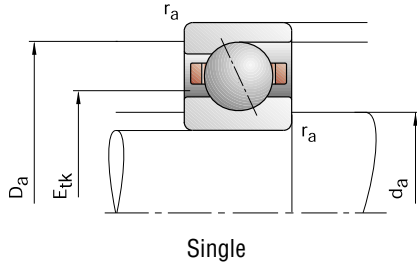

Single

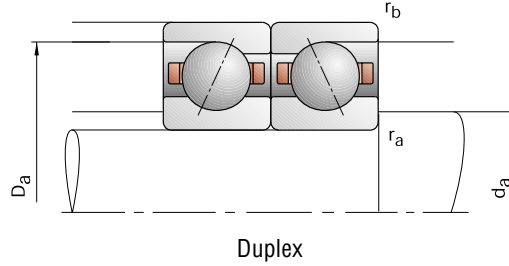

Duplex

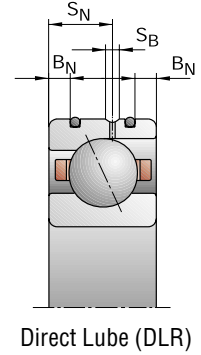

Direct Lube (DLR)

Barden Basic Bearing Number	Dimensions					Shaft & Shoulder Housing Dimensions				DLR Dimensions				Load Ratings			
	d	D	B	r <sub>smin</sub>	r <sub>1smin</sub>	d <sub>a</sub> h12	D <sub>a</sub> H12	r <sub>a</sub> max	r <sub>b</sub> max	B <sub>N</sub>	S <sub>N</sub>	S <sub>B</sub>	E <sub>tk</sub>	C <sub>dyn</sub>	C <sub>0stat</sub>		
	mm															kN	
1815HC	75	95	10	0.60	0.30	79	90.5	0.6	0.3				82.3	14.30	15.60		
1815HE	75	95	10	0.60	0.30	79	90.5	0.6	0.3				82.3	13.40	14.60		
C1815HC	75	95	10	0.60	0.30	79	90.5	0.6	0.3				82.3	9.80	11.00		
C1815HE	75	95	10	0.60	0.30	79	90.5	0.6	0.3				82.3	9.30	10.20		
1915HC	75	105	16	1.00	1.00	81	99.5	0.6	0.6				87.2	34.00	34.50		
1915HE	75	105	16	1.00	1.00	81	99.5	0.6	0.6				87.2	32.00	32.50		
C1915HC	75	105	16	1.00	1.00	81	99.5	0.6	0.6	3.1	9.3	1.4	87.2	23.60	24.00		
C1915HE	75	105	16	1.00	1.00	81	99.5	0.6	0.6	3.1	9.3	1.4	87.2	22.00	22.80		
XC1915HC	75	105	16	1.00	1.00	81	99.5	0.6	0.6	3.1	9.3	1.4	87.2	53.00	24.00		
XC1915HE	75	105	16	1.00	1.00	81	99.5	0.6	0.6	3.1	9.3	1.4	87.2	49.00	22.80		
ZSB1915C	75	105	16	1.00	1.00	81	99.5	0.6	0.6				87.3	19.00	21.20		
ZSB1915E	75	105	16	1.00	1.00	81	99.5	0.6	0.6				87.3	17.60	20.00		
CZSB1915C	75	105	16	1.00	1.00	81	99.5	0.6	0.6	3.1	9.3	1.4	87.3	12.90	15.00		
CZSB1915E	75	105	16	1.00	1.00	81	99.5	0.6	0.6	3.1	9.3	1.4	87.3	12.20	13.70		
XCZSB1915C	75	105	16	1.00	1.00	81	99.5	0.6	0.6	3.1	9.3	1.4	87.3	29.00	15.00		
XCZSB1915E	75	105	16	1.00	1.00	81	99.5	0.6	0.6	3.1	9.3	1.4	87.3	27.00	13.70		
115HC	75	115	20	1.10	1.10	82	107	1.0	0.6				90.0	51.00	46.50		
115HE	75	115	20	1.10	1.10	82	107	1.0	0.6				90.0	48.00	44.00		
C115HC	75	115	20	1.10	1.10	82	107	1.0	0.6	4.0	11.6	1.4	90.0	35.50	32.50		
C115HE	75	115	20	1.10	1.10	82	107	1.0	0.6	4.0	11.6	1.4	90.0	33.50	30.50		
XC115HC	75	115	20	1.10	1.10	82	107	1.0	0.6	4.0	11.6	1.4	90.0	80.00	32.50		
XC115HE	75	115	20	1.10	1.10	82	107	1.0	0.6	4.0	11.6	1.4	90.0	75.00	30.50		
ZSB115C	75	115	20	1.10	1.10	82	107	1.0	0.6				91.7	26.50	29.00		
ZSB115E	75	115	20	1.10	1.10	82	107	1.0	0.6				91.7	25.00	27.00		
CZSB115C	75	115	20	1.10	1.10	82	107	1.0	0.6	4.0	11.6	1.4	91.7	18.30	20.00		
CZSB115E	75	115	20	1.10	1.10	82	107	1.0	0.6	4.0	11.6	1.4	91.7	17.30	18.60		
XCZSB115C	75	115	20	1.10	1.10	82	107	1.0	0.6	4.0	11.6	1.4	91.7	40.50	20.00		
XCZSB115E	75	115	20	1.10	1.10	82	107	1.0	0.6	4.0	11.6	1.4	91.7	38.00	18.60		
215HC	75	130	25	1.50	1.50	85	120	1.5	1.5				97.7	72.00	63.00		
215HE	75	130	25	1.50	1.50	85	120	1.5	1.5				97.7	68.00	60.00		
C215HC	75	130	25	1.50	1.50	85	120	1.5	1.5				97.7	50.00	44.00		
C215HE	75	130	25	1.50	1.50	85	120	1.5	1.5				97.7	47.50	41.50		

**Designation examples:**

Barden

FAG

**Sealed design**

115HCRRUL

(B7015C.2RSD.T.P4S.UL)

**Hybrid ceramic design**

C115HCUL

(HCB7015C.T.P4S.UL)



# SPINDLE BEARINGS

## 1800HC/E, 1900HC/E, 100HC/E, 200HC/E, ZSB1900C/E, ZSB100C/E

C: Contact Angle  $\alpha = 15^\circ$  / E: Contact Angle  $\alpha = 25^\circ$

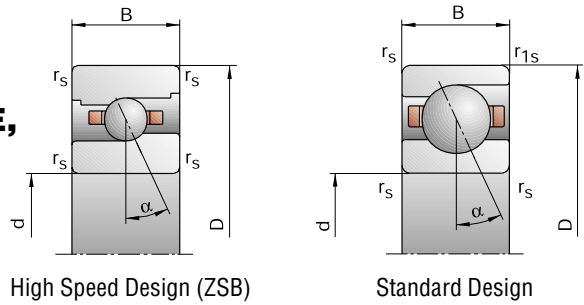

High Speed Design (ZSB)

Standard Design

Attainable Speed*		Standard Preload $F_V$ (Force)			Unloading Force $K_{aE}$			Axial Rigidity $S_a$			Sealed Design	Weight	FAG Basic Bearing Number†
Grease	Oil minimal	L	M	H	L	M	H	L	M	H		kg	
min <sup>-1</sup>		N						N/μm					
13000	20000	53	213	467	159	695	1638	47.7	87.8	130.1	–	0.14	B71815C.TPA.P4
12000	19000	84	298	702	241	881	2150	116.8	187.3	264.5	–	0.14	B71815E.TPA.P4
16000	26000	24	120	280	71	377	933	39.8	75.6	111.2	–	0.14	HCB71815C.TPA.P4
14000	22000	41	148	392	118	434	1180	103.0	163.0	235.4	–	0.14	HCB71815E.TPA.P4
12000	19000	174	596	1246	537	1991	4460	68.5	118.8	172.7	•	0.35	B71915C.T.P4S
11000	18000	236	901	1943	689	2721	6055	156.2	258.3	353.3	•	0.35	B71915E.T.P4S
16000	26000	84	320	691	254	1025	2336	57.7	99.6	141.7	•	0.30	HCB71915C.T.P4S
13000	20000	96	457	1039	280	1365	3179	128.9	225.4	308.4	•	0.30	HCB71915E.T.P4S
20000	34000	84	320	691	254	1025	2336	57.7	99.6	141.7	•	0.30	XCB71915C.T.P4S
17000	28000	96	457	1039	280	1365	3179	128.9	225.4	308.4	•	0.30	XCB71915E.T.P4S
16000	26000	65	196	391	193	611	1276	49.8	78.3	107.0	•	0.40	HS71915C.T.P4S
13000	20000	105	315	630	301	918	1872	124.8	185.4	241.4	•	0.40	HS71915E.T.P4S
18000	30000	45	134	268	133	412	852	48.8	74.9	100.3	•	0.37	HC71915C.T.P4S
15000	24000	73	219	437	211	641	1297	125.0	184.1	237.4	•	0.37	HC71915E.T.P4S
23000	40000	45	134	268	133	412	852	48.8	74.9	100.3	•	0.37	XC71915C.T.P4S
19000	32000	73	219	437	211	641	1297	125.0	184.1	237.4	•	0.37	XC71915E.T.P4S
12000	19000	283	931	1923	880	3138	6964	76.8	131.9	191.7	•	0.62	B7015C.T.P4S
11000	18000	408	1439	3027	1196	4365	9505	177.7	286.7	389.8	•	0.62	B7015E.T.P4S
15000	24000	144	509	1071	439	1643	3650	65.9	111.0	156.8	•	0.53	HCB7015C.T.P4S
13000	20000	190	762	1667	557	2285	5122	153.6	253.5	342.7	•	0.53	HCB7015E.T.P4S
19000	32000	144	509	1071	439	1643	3650	65.9	111.0	156.8	•	0.53	XCB7015C.T.P4S
16000	26000	190	762	1667	557	2285	5122	153.6	253.5	342.7	•	0.53	XCB7015E.T.P4S
15000	24000	91	273	547	270	852	1790	54.0	85.0	116.7	•	0.71	HS7015C.T.P4S
13000	20000	148	444	888	425	1297	2647	135.8	201.9	263.2	•	0.71	HS7015E.T.P4S
17000	28000	63	188	375	187	578	1199	53.2	81.4	109.5	•	0.66	HC7015C.T.P4S
15000	24000	101	304	607	292	891	1805	134.9	199.2	257.0	•	0.66	HC7015E.T.P4S
22000	36000	63	188	375	187	578	1199	53.2	81.4	109.5	•	0.66	XC7015C.T.P4S
19000	32000	101	304	607	292	891	1805	134.9	199.2	257.0	•	0.66	XC7015E.T.P4S
11000	18000	416	1346	2757	1299	4560	10021	87.8	150.1	217.4	•	1.21	B7215C.T.P4S
9500	16000	619	2103	4389	1820	6402	13790	204.9	326.6	442.6	•	1.21	B7215E.T.P4S
14000	22000	215	733	1531	656	2375	5239	75.5	125.8	177.4	•	1.05	HCB7215C.T.P4S
12000	19000	306	1142	2439	900	3436	7503	180.6	291.2	390.2	•	1.05	HCB7215E.T.P4S

### Direct lube design

Consult Barden  
(HCB7015EDLR.T.P4S.UL)

### X-life ultra design

**XC115HCUL**  
(XCB7015C.T.P4S.UL)

† FAG Basic Bearing Number is for reference only. All bearings are available exclusively from Barden, and must be ordered using the Barden Basic Bearing Number.

\* = speeds indicated are for spring preloads.



# SPINDLE BEARINGS

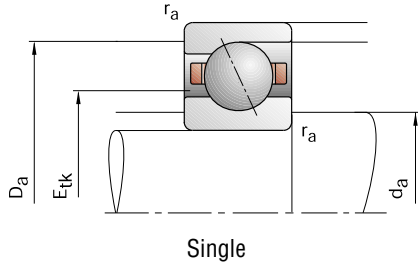

Single

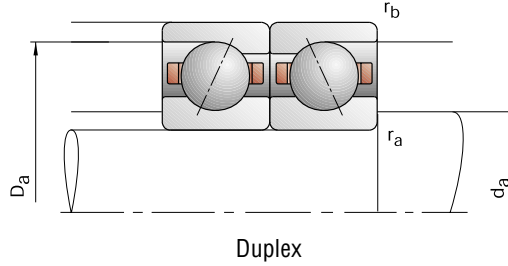

Duplex

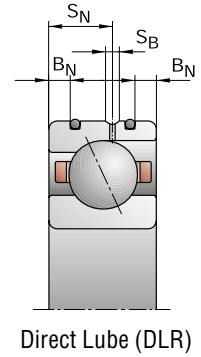

Direct Lube (DLR)

Barden Basic Bearing Number	Dimensions					Shaft & Shoulder Housing Dimensions				DLR Dimensions				Load Ratings	
	d	D	B	r <sub>smin</sub>	r <sub>1smin</sub>	d <sub>a</sub>	D <sub>a</sub>	r <sub>a</sub>	r <sub>b</sub>	B <sub>N</sub>	S <sub>N</sub>	S <sub>B</sub>	E <sub>tk</sub>	C <sub>dyn</sub>	C <sub>0stat</sub>
	mm														
1816HC	80	100	10	0.60	0.30	84	95.5	0.6	0.3				87.3	14.60	16.60
1816HE	80	100	10	0.60	0.30	84	95.5	0.6	0.3				87.3	13.70	15.60
C1816HC	80	100	10	0.60	0.30	84	95.5	0.6	0.3				87.3	10.00	11.60
C1816HE	80	100	10	0.60	0.30	84	95.5	0.6	0.3				87.3	9.50	10.80
1916HC	80	110	16	1.00	1.00	86	104	0.6	0.6				92.2	34.50	36.00
1916HE	80	110	16	1.00	1.00	86	104	0.6	0.6				92.2	32.50	34.00
C1916HC	80	110	16	1.00	1.00	86	104	0.6	0.6	3.1	9.3	1.4	92.2	24.00	25.00
C1916HE	80	110	16	1.00	1.00	86	104	0.6	0.6	3.1	9.3	1.4	92.2	22.40	23.60
XC1916HC	80	110	16	1.00	1.00	86	104	0.6	0.6	3.1	9.3	1.4	92.2	54.00	25.00
XC1916HE	80	110	16	1.00	1.00	86	104	0.6	0.6	3.1	9.3	1.4	92.2	50.00	23.60
ZSB1916C	80	110	16	1.00	1.00	86	104	0.6	0.6				92.2	21.20	24.00
ZSB1916E	80	110	16	1.00	1.00	86	104	0.6	0.6				92.2	19.60	22.40
CZSB1916C	80	110	16	1.00	1.00	86	104	0.6	0.6	3.1	9.3	1.4	92.2	14.60	16.60
CZSB1916E	80	110	16	1.00	1.00	86	104	0.6	0.6	3.1	9.3	1.4	92.2	13.70	15.60
XCZSB1916C	80	110	16	1.00	1.00	86	104	0.6	0.6	3.1	9.3	1.4	92.2	32.50	16.60
XCZSB1916E	80	110	16	1.00	1.00	86	104	0.6	0.6	3.1	9.3	1.4	92.2	30.50	15.60
116HC	80	125	22	1.10	1.10	88	117	1.0	0.6				96.8	63.00	58.50
116HE	80	125	22	1.10	1.10	88	117	1.0	0.6				96.8	60.00	55.00
C116HC	80	125	22	1.10	1.10	88	117	1.0	0.6	4.7	12.2	2.2	96.8	44.00	40.50
C116HE	80	125	22	1.10	1.10	88	117	1.0	0.6	4.7	12.2	2.2	96.8	41.50	39.00
XC116HC	80	125	22	1.10	1.10	88	117	1.0	0.6	4.7	12.2	2.2	96.8	98.00	40.50
XC116HE	80	125	22	1.10	1.10	88	117	1.0	0.6	4.7	12.2	2.2	96.8	93.00	39.00
ZSB116C	80	125	22	1.10	1.10	88	117	1.0	0.6				98.9	31.50	34.50
ZSB116E	80	125	22	1.10	1.10	88	117	1.0	0.6				98.9	30.00	32.50
CZSB116C	80	125	22	1.10	1.10	88	117	1.0	0.6	4.7	12.2	2.2	98.9	21.60	24.50
CZSB116E	80	125	22	1.10	1.10	88	117	1.0	0.6	4.7	12.2	2.2	98.9	20.40	22.80
XCZSB116C	80	125	22	1.10	1.10	88	117	1.0	0.6	4.7	12.2	2.2	98.9	48.00	24.50
XCZSB116E	80	125	22	1.10	1.10	88	117	1.0	0.6	4.7	12.2	2.2	98.9	45.50	22.80
216HC	80	140	26	2.00	2.00	91	129	2.0	2.0				104.3	93.00	78.00
216HE	80	140	26	2.00	2.00	91	129	2.0	2.0				104.3	88.00	73.50
C216HC	80	140	26	2.00	2.00	91	129	2.0	2.0				104.3	64.00	54.00
C216HE	80	140	26	2.00	2.00	91	129	2.0	2.0				104.3	61.00	51.00

**Designation examples:**

Barden

FAG

**Sealed design**

116HCRRUL

(B7016C.2RSD.T.P4S.UL)

**Hybrid ceramic design**

C116HCUL

(HCB7016C.T.P4S.UL)

# SPINDLE BEARINGS

## 1800HC/E, 1900HC/E, 100HC/E, 200HC/E, ZSB1900C/E, ZSB100C/E

C: Contact Angle  $\alpha = 15^\circ$  / E: Contact Angle  $\alpha = 25^\circ$

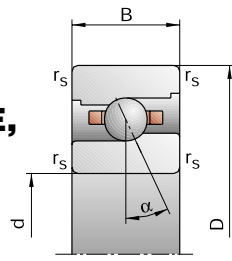

High Speed Design (ZSB)

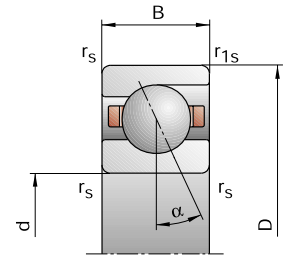

Standard Design

Attainable Speed*		Standard Preload $F_V$ (Force)			Unloading Force $K_{aE}$			Axial Rigidity $S_a$			Sealed Design	Weight	FAG Basic Bearing Number†		
Grease	Oil minimal	L	M	H	L	M	H	L	M	H		kg			
min <sup>-1</sup>		N											N/μm	kg	
12000	19000	53	216	474	159	703	1655	49.5	91.2	134.9	–	0.15	B71816C.TPA.P4		
11000	18000	84	302	712	241	892	2176	121.4	195.3	275.3	–	0.15	B71816E.TPA.P4		
16000	26000	23	121	282	68	379	935	40.7	78.4	115.0	–	0.15	HCB71816C.TPA.P4		
13000	20000	41	152	402	118	445	1208	107.1	170.7	246.3	–	0.15	HCB71816E.TPA.P4		
12000	19000	175	603	1262	539	2009	4504	70.3	122.0	177.2	•	0.37	B71916C.T.P4S		
11000	18000	238	911	1969	695	2748	6127	160.9	266.0	363.7	•	0.37	B71916E.T.P4S		
15000	24000	83	319	689	251	1019	2320	59.0	101.8	144.5	•	0.31	HCB71916C.T.P4S		
13000	20000	96	462	1052	280	1379	3215	132.5	232.3	317.6	•	0.31	HCB71916E.T.P4S		
19000	32000	83	319	689	251	1019	2320	59.0	101.8	144.5	•	0.31	XCB71916C.T.P4S		
16000	26000	96	462	1052	280	1379	3215	132.5	232.3	317.6	•	0.31	XCB71916E.T.P4S		
15000	24000	73	218	437	217	679	1425	52.9	82.6	113.1	•	0.41	HS71916C.T.P4S		
13000	20000	117	352	704	335	1026	2092	131.8	196.3	255.6	•	0.41	HS71916E.T.P4S		
17000	28000	50	150	300	148	461	954	51.7	79.3	106.3	•	0.38	HC71916C.T.P4S		
15000	24000	81	244	488	234	714	1448	132.0	194.7	251.1	•	0.38	HC71916E.T.P4S		
22000	36000	50	150	300	148	461	954	51.7	79.3	106.3	•	0.38	XC71916C.T.P4S		
19000	32000	81	244	488	234	714	1448	132.0	194.7	251.1	•	0.38	XC71916E.T.P4S		
11000	18000	357	1163	2391	1110	3920	8635	86.3	147.5	213.5	•	0.84	B7016C.T.P4S		
9500	16000	529	1830	3825	1552	5557	11989	201.7	323.3	437.9	•	0.84	B7016E.T.P4S		
14000	22000	185	643	1345	564	2077	4585	74.5	124.8	175.8	•	0.71	HCB7016C.T.P4S		
12000	19000	250	967	2089	734	2902	6423	175.2	285.5	384.2	•	0.71	HCB7016E.T.P4S		
18000	30000	185	643	1345	564	2077	4585	74.5	124.8	175.8	•	0.71	XCB7016C.T.P4S		
15000	24000	250	967	2089	734	2902	6423	175.2	285.5	384.2	•	0.71	XCB7016E.T.P4S		
14000	22000	109	328	657	323	1024	2150	59.1	93.2	127.9	•	0.96	HS7016C.T.P4S		
12000	19000	175	524	1049	502	1530	3127	147.9	220.0	287.0	•	0.96	HS7016E.T.P4S		
16000	26000	74	222	445	219	682	1418	57.7	88.7	119.3	•	0.89	HC7016C.T.P4S		
13000	20000	123	368	736	355	1079	2185	148.4	219.2	282.8	•	0.89	HC7016E.T.P4S		
20000	34000	74	222	445	219	682	1418	57.7	88.7	119.3	•	0.89	XC7016C.T.P4S		
17000	28000	123	368	736	355	1079	2185	148.4	219.2	282.8	•	0.89	XC7016E.T.P4S		
10000	17000	553	1761	3602	1730	5976	13149	94.8	161.2	233.8	–	1.47	B7216C.T.P4S		
9000	15000	839	2783	5750	2474	8475	18117	222.2	351.3	475.0	–	1.47	B7216E.T.P4S		
12000	19000	290	964	1992	888	3127	6823	81.9	135.2	190.0	–	1.21	HCB7216C.T.P4S		
11000	18000	423	1511	3197	1247	4558	9859	197.1	313.2	418.6	–	1.21	HCB7216E.T.P4S		

**Direct lube design**  
Consult Barden  
(HCB7016EDLR.T.P4S.UL)

**X-life ultra design**  
**XC116HCUL**  
(XCB7016C.T.P4S.UL)

† FAG Basic Bearing Number is for reference only. All bearings are available exclusively from Barden, and must be ordered using the Barden Basic Bearing Number.

\* = speeds indicated are for spring preloads.



# SPINDLE BEARINGS

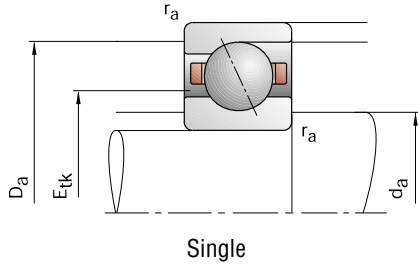

Single

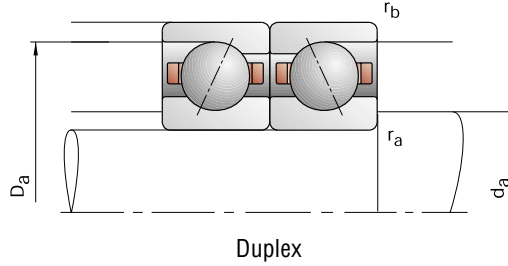

Duplex

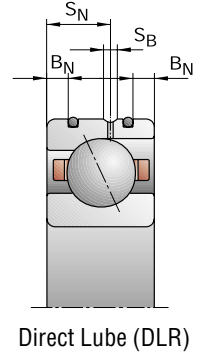

Direct Lube (DLR)

Barden Basic Bearing Number	Dimensions					Shaft & Shoulder Housing Dimensions				DLR Dimensions				Load Ratings	
	d	D	B	r <sub>smin</sub>	r <sub>1smin</sub>	d <sub>a</sub>	D <sub>a</sub>	r <sub>a</sub>	r <sub>b</sub>	B <sub>N</sub>	S <sub>N</sub>	S <sub>B</sub>	E <sub>tk</sub>	C <sub>dyn</sub>	C <sub>0stat</sub>
	mm														
1817HC	85	110	13	1.00	0.30	90	104.5	1.0	0.3				94.1	21.60	24.00
1817HE	85	110	13	1.00	0.30	90	104.5	1.0	0.3				94.1	20.40	22.40
C1817HC	85	110	13	1.00	0.30	90	104.5	1.0	0.3				94.1	15.00	16.60
C1817HE	85	110	13	1.00	0.30	90	104.5	1.0	0.3				94.1	14.00	15.60
1917HC	85	120	18	1.10	1.10	92	114	0.6	0.6				99.2	45.00	46.50
1917HE	85	120	18	1.10	1.10	92	114	0.6	0.6				99.2	42.50	44.00
C1917HC	85	120	18	1.10	1.10	92	114	0.6	0.6	4.0	10.4	2.2	99.2	31.00	32.50
C1917HE	85	120	18	1.10	1.10	92	114	0.6	0.6	4.0	10.4	2.2	99.2	29.00	30.50
XC1917HC	85	120	18	1.10	1.10	92	114	0.6	0.6	4.0	10.4	2.2	99.2	69.50	32.50
XC1917HE	85	120	18	1.10	1.10	92	114	0.6	0.6	4.0	10.4	2.2	99.2	64.00	30.50
ZSB1917C	85	120	18	1.10	1.10	92	114	0.6	0.6				99.7	22.00	26.00
ZSB1917E	85	120	18	1.10	1.10	92	114	0.6	0.6				99.7	20.40	24.50
CZSB1917C	85	120	18	1.10	1.10	92	114	0.6	0.6	4.0	10.4	2.2	99.7	15.00	18.00
CZSB1917E	85	120	18	1.10	1.10	92	114	0.6	0.6	4.0	10.4	2.2	99.7	14.30	17.00
XCZSB1917C	85	120	18	1.10	1.10	92	114	0.6	0.6	4.0	10.4	2.2	99.7	33.50	18.00
XCZSB1917E	85	120	18	1.10	1.10	92	114	0.6	0.6	4.0	10.4	2.2	99.7	32.00	17.00
117HC	85	130	22	1.10	1.10	93	122	1.0	0.6				101.8	65.50	62.00
117HE	85	130	22	1.10	1.10	93	122	1.0	0.6				101.8	62.00	58.50
C117HC	85	130	22	1.10	1.10	93	122	1.0	0.6	4.7	12.2	2.2	101.8	45.00	43.00
C117HE	85	130	22	1.10	1.10	93	122	1.0	0.6	4.7	12.2	2.2	101.8	42.50	40.50
XC117HC	85	130	22	1.10	1.10	93	122	1.0	0.6	4.7	12.2	2.2	101.8	100.00	43.00
XC117HE	85	130	22	1.10	1.10	93	122	1.0	0.6	4.7	12.2	2.2	101.8	95.00	40.50
ZSB117C	85	130	22	1.10	1.10	93	122	1.0	0.6				103.9	32.00	36.00
ZSB117E	85	130	22	1.10	1.10	93	122	1.0	0.6				103.9	30.00	33.50
CZSB117C	85	130	22	1.10	1.10	93	122	1.0	0.6	4.7	12.2	2.2	103.9	22.00	25.00
CZSB117E	85	130	22	1.10	1.10	93	122	1.0	0.6	4.7	12.2	2.2	103.9	20.80	23.20
XCZSB117C	85	130	22	1.10	1.10	93	122	1.0	0.6	4.7	12.2	2.2	103.9	49.00	25.00
XCZSB117E	85	130	22	1.10	1.10	93	122	1.0	0.6	4.7	12.2	2.2	103.9	46.50	23.20
217HC	85	150	28	2.00	2.00	98	138	2.0	2.0				112.3	96.50	85.00
217HE	85	150	28	2.00	2.00	98	138	2.0	2.0				112.3	91.50	80.00
C217HC	85	150	28	2.00	2.00	98	138	2.0	2.0				112.3	67.00	58.50
C217HE	85	150	28	2.00	2.00	98	138	2.0	2.0				112.3	63.00	56.00

**Designation examples:**

Barden

FAG

**Sealed design**

117HCRRUL

(B7017C.2RSD.T.P4S.UL)

**Hybrid ceramic design**

C117HCUL

(HCB7017C.T.P4S.UL)

# SPINDLE BEARINGS

## 1800HC/E, 1900HC/E, 100HC/E, 200HC/E, ZSB1900C/E, ZSB100C/E

C: Contact Angle  $\alpha = 15^\circ$  / E: Contact Angle  $\alpha = 25^\circ$

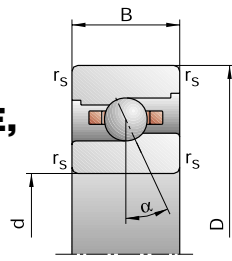

High Speed Design (ZSB)

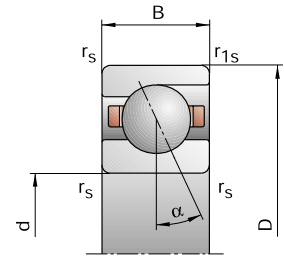

Standard Design

Attainable Speed*		Standard Preload $F_V$ (Force)			Unloading Force $K_{aE}$			Axial Rigidity $S_a$			Sealed Design	Weight	FAG Basic Bearing Number†
Grease	Oil minimal	L	M	H	L	M	H	L	M	H		kg	
min <sup>-1</sup>		N						N/μm					
11000	18000	93	344	739	281	1129	2603	59.5	106.2	156.2	–	0.27	B71817C.TPA.P4
10000	17000	113	507	1142	325	1508	3507	131.7	230.0	319.4	–	0.27	B71817E.TPA.P4
14000	22000	48	205	457	143	650	1532	51.8	93.4	135.2	–	0.27	HCB71817C.TPA.P4
12000	19000	89	279	678	258	823	2048	137.5	207.1	290.5	–	0.27	HCB71817E.TPA.P4
11000	18000	239	804	1672	739	2687	5982	80.3	138.0	200.0	•	0.53	B71917C.T.P4S
9500	16000	336	1232	2631	983	3716	8205	185.3	301.8	411.4	•	0.53	B71917E.T.P4S
13000	20000	120	438	934	363	1405	3160	68.6	116.5	164.9	•	0.45	HCB71917C.T.P4S
12000	19000	148	642	1436	433	1921	4389	157.3	266.2	361.7	•	0.45	HCB71917E.T.P4S
18000	30000	120	438	934	363	1405	3160	68.6	116.5	164.9	•	0.45	XCB71917C.T.P4S
15000	24000	148	642	1436	433	1921	4389	157.3	266.2	361.7	•	0.45	XCB71917E.T.P4S
14000	22000	76	228	456	225	708	1482	56.4	88.3	120.7	•	0.61	HS71917C.T.P4S
12000	19000	123	368	736	352	1071	2184	141.7	210.4	273.8	•	0.61	HS71917E.T.P4S
16000	26000	53	158	316	157	485	1003	55.8	85.2	114.0	•	0.57	HC71917C.T.P4S
13000	20000	84	253	506	242	739	1499	140.9	208.0	268.3	•	0.57	HC71917E.T.P4S
20000	34000	53	158	316	157	485	1003	55.8	85.2	114.0	•	0.57	XC71917C.T.P4S
17000	28000	84	253	506	242	739	1499	140.9	208.0	268.3	•	0.57	XC71917E.T.P4S
10000	17000	370	1209	2484	1150	4070	8957	90.3	154.3	223.1	•	0.89	B7017C.T.P4S
9000	15000	545	1888	3949	1598	5728	12364	210.6	337.5	457.1	•	0.89	B7017E.T.P4S
13000	20000	192	667	1401	585	2152	4772	78.0	130.5	184.1	•	0.74	HCB7017C.T.P4S
11000	18000	260	1008	2179	763	3024	6697	183.6	299.5	402.9	•	0.74	HCB7017E.T.P4S
17000	28000	192	667	1401	585	2152	4772	78.0	130.5	184.1	•	0.74	XCB7017C.T.P4S
14000	22000	260	1008	2179	763	3024	6697	183.6	299.5	402.9	•	0.74	XCB7017E.T.P4S
13000	20000	109	328	657	323	1022	2144	60.5	95.1	130.2	•	0.99	HS7017C.T.P4S
11000	18000	178	534	1067	509	1559	3178	151.9	226.4	294.9	•	0.99	HS7017E.T.P4S
15000	24000	76	228	456	225	700	1452	59.6	91.5	122.9	•	0.92	HC7017C.T.P4S
13000	20000	123	368	736	355	1079	2183	151.8	224.1	288.9	•	0.93	HC7017E.T.P4S
19000	32000	76	228	456	225	700	1452	59.6	91.5	122.9	•	0.92	XC7017C.T.P4S
16000	26000	123	368	736	355	1079	2183	151.8	224.1	288.9	•	0.93	XC7017E.T.P4S
9000	15000	573	1825	3734	1789	6176	13586	99.8	169.5	245.6	–	1.85	B7217C.T.P4S
8000	13000	869	2889	5972	2554	8786	18785	234.3	370.6	500.9	–	1.85	B7217E.T.P4S
11000	18000	301	999	2066	920	3234	7057	86.4	142.4	199.8	–	1.58	HCB7217C.T.P4S
10000	17000	437	1567	3319	1287	4722	10222	207.8	330.5	441.6	–	1.58	HCB7217E.T.P4S

**Direct lube design**  
Consult Barden  
(HCB7017EDLR.T.P4S.UL)

**X-life ultra design**  
**XC117HCUL**  
(XCB7017C.T.P4S.UL)

† FAG Basic Bearing Number is for reference only. All bearings are available exclusively from Barden, and must be ordered using the Barden Basic Bearing Number.

\* = speeds indicated are for spring preloads.



# SPINDLE BEARINGS

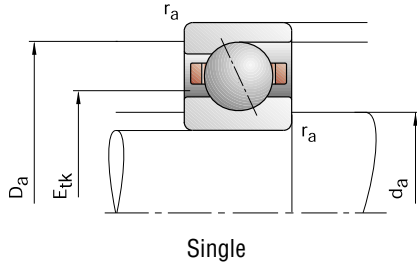

Single

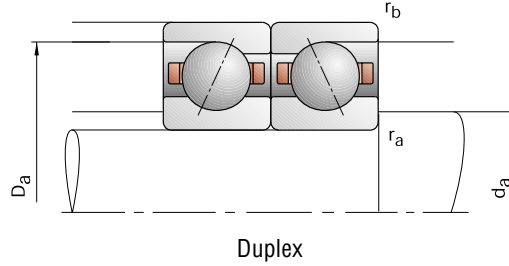

Duplex

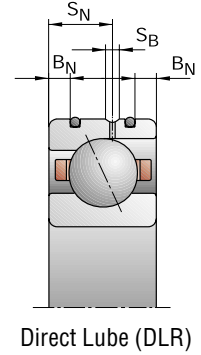

Direct Lube (DLR)

Barden Basic Bearing Number	Dimensions					Shaft & Shoulder Housing Dimensions				DLR Dimensions				Load Ratings	
	d	D	B	r <sub>smin</sub>	r <sub>1smin</sub>	d <sub>a</sub>	D <sub>a</sub>	r <sub>a</sub>	r <sub>b</sub>	B <sub>N</sub>	S <sub>N</sub>	S <sub>B</sub>	E <sub>tk</sub>	C <sub>dyn</sub>	C <sub>0stat</sub>
	mm														
1818HC	90	115	13	1.00	0.30	95	109.5	1.0	0.3				99.4	21.20	23.60
1818HE	90	115	13	1.00	0.30	95	109.5	1.0	0.3				99.4	20.00	22.00
C1818HC	90	115	13	1.00	0.30	95	109.5	1.0	0.3				99.4	14.60	16.60
C1818HE	90	115	13	1.00	0.30	95	109.5	1.0	0.3				99.4	14.00	15.30
1918HC	90	125	18	1.10	1.10	97	119	0.6	0.6				104.2	45.50	49.00
1918HE	90	125	18	1.10	1.10	97	119	0.6	0.6				104.2	43.00	46.50
C1918HC	90	125	18	1.10	1.10	97	119	0.6	0.6	4.0	10.4	2.2	104.2	31.50	34.00
C1918HE	90	125	18	1.10	1.10	97	119	0.6	0.6	4.0	10.4	2.2	104.2	30.00	32.00
XC1918HC	90	125	18	1.10	1.10	97	119	0.6	0.6	4.0	10.4	2.2	104.2	71.00	34.00
XC1918HE	90	125	18	1.10	1.10	97	119	0.6	0.6	4.0	10.4	2.2	104.2	67.00	32.00
ZSB1918C	90	125	18	1.10	1.10	97	119	0.6	0.6				104.5	23.60	28.50
ZSB1918E	90	125	18	1.10	1.10	97	119	0.6	0.6				104.5	22.40	26.50
CZSB1918C	90	125	18	1.10	1.10	97	119	0.6	0.6	4.0	10.4	2.2	104.5	16.30	19.60
CZSB1918E	90	125	18	1.10	1.10	97	119	0.6	0.6	4.0	10.4	2.2	104.5	15.60	18.60
XCZSB1918C	90	125	18	1.10	1.10	97	119	0.6	0.6	4.0	10.4	2.2	104.5	36.50	19.60
XCZSB1918E	90	125	18	1.10	1.10	97	119	0.6	0.6	4.0	10.4	2.2	104.5	34.50	18.60
118HC	90	140	24	1.50	1.50	100	131	1.5	0.6				108.6	76.50	72.00
118HE	90	140	24	1.50	1.50	100	131	1.5	0.6				108.6	72.00	68.00
C118HC	90	140	24	1.50	1.50	100	131	1.5	0.6	5.5	14.5	2.2	108.6	53.00	50.00
C118HE	90	140	24	1.50	1.50	100	131	1.5	0.6	5.5	14.5	2.2	108.6	50.00	47.50
XC118HC	90	140	24	1.50	1.50	100	131	1.5	0.6	5.5	14.5	2.2	108.6	118.00	50.00
XC118HE	90	140	24	1.50	1.50	100	131	1.5	0.6	5.5	14.5	2.2	108.6	112.00	47.50
ZSB118C	90	140	24	1.50	1.50	100	131	1.5	0.6				111.0	37.50	43.00
ZSB118E	90	140	24	1.50	1.50	100	131	1.5	0.6				111.0	35.50	40.00
CZSB118C	90	140	24	1.50	1.50	100	131	1.5	0.6	5.5	14.5	2.2	111.0	26.00	30.00
CZSB118E	90	140	24	1.50	1.50	100	131	1.5	0.6	5.5	14.5	2.2	111.0	24.50	28.00
XCZSB118C	90	140	24	1.50	1.50	100	131	1.5	0.6	5.5	14.5	2.2	111.0	58.50	30.00
XCZSB118E	90	140	24	1.50	1.50	100	131	1.5	0.6	5.5	14.5	2.2	111.0	55.00	28.00
218HC	90	160	30	2.00	2.00	104	147	2.0	2.0				118.8	122.00	104.00
218HE	90	160	30	2.00	2.00	104	147	2.0	2.0				118.8	116.00	100.00
C218HC	90	160	30	2.00	2.00	104	147	2.0	2.0				118.8	85.00	73.50
C218HE	90	160	30	2.00	2.00	104	147	2.0	2.0				118.8	80.00	69.50

**Designation examples:**

Barden

FAG

**Sealed design**

118HCRRUL

(B7018C.2RSD.T.P4S.UL)

**Hybrid ceramic design**

C118HCUL

(HCB7018C.T.P4S.UL)



# SPINDLE BEARINGS

## 1800HC/E, 1900HC/E, 100HC/E, 200HC/E, ZSB1900C/E, ZSB100C/E

C: Contact Angle  $\alpha = 15^\circ$  / E: Contact Angle  $\alpha = 25^\circ$

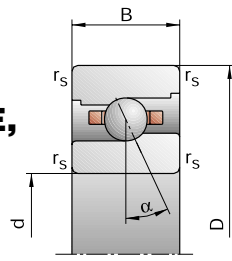

High Speed Design (ZSB)

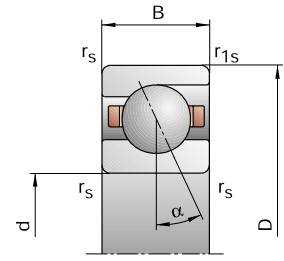

Standard Design

Attainable Speed*		Standard Preload $F_V$ (Force)			Unloading Force $K_{aE}$			Axial Rigidity $S_a$			Sealed Design	Weight	FAG Basic Bearing Number†		
Grease	Oil minimal	L	M	H	L	M	H	L	M	H		kg			
min <sup>-1</sup>		N											N/μm	kg	
11000	18000	91	337	724	275	1104	2544	59.0	105.2	154.5	–	0.28	B71818C.TPA.P4		
9500	16000	110	495	1116	316	1471	3423	130.4	227.8	316.3	–	0.28	B71818E.TPA.P4		
14000	22000	47	200	446	140	633	1496	51.4	92.4	133.8	–	0.28	HCB71818C.TPA.P4		
12000	19000	79	271	659	228	799	1989	131.5	205.0	287.4	–	0.28	HCB71818E.TPA.P4		
10000	17000	240	811	1688	740	2703	6019	82.3	141.6	204.9	•	0.55	B71918C.T.P4S		
9000	15000	337	1243	2655	985	3745	8266	190.3	310.5	422.9	•	0.55	B71918E.T.P4S		
13000	20000	122	445	950	369	1425	3207	70.9	120.1	169.8	•	0.47	HCB71918C.T.P4S		
11000	18000	149	653	1461	436	1953	4461	162.0	274.9	373.3	•	0.47	HCB71918E.T.P4S		
17000	28000	122	445	950	369	1425	3207	70.9	120.1	169.8	•	0.47	XCB71918C.T.P4S		
14000	22000	149	653	1461	436	1953	4461	162.0	274.9	373.3	•	0.47	XCB71918E.T.P4S		
13000	20000	83	249	498	246	772	1620	58.2	91.0	124.5	•	0.63	HS71918C.T.P4S		
11000	18000	133	398	796	381	1158	2362	145.7	216.0	281.2	•	0.63	HS71918E.T.P4S		
15000	24000	57	170	340	168	520	1078	56.9	87.1	116.7	•	0.58	HC71918C.T.P4S		
13000	20000	92	276	552	265	807	1636	145.3	214.5	276.5	•	0.58	HC71918E.T.P4S		
19000	32000	57	170	340	168	520	1078	56.9	87.1	116.7	•	0.58	XC71918C.T.P4S		
16000	26000	92	276	552	265	807	1636	145.3	214.5	276.5	•	0.58	XC71918E.T.P4S		
9500	16000	440	1427	2925	1369	4810	10569	95.8	163.5	236.2	•	1.15	B7018C.T.P4S		
8500	14000	649	2217	4623	1905	6732	14476	223.6	356.6	482.2	•	1.15	B7018E.T.P4S		
12000	19000	227	775	1622	691	2501	5523	82.6	137.2	193.2	•	0.96	HCB7018C.T.P4S		
10000	17000	319	1207	2585	937	3625	7934	196.9	318.6	427.0	•	0.96	HCB7018E.T.P4S		
15000	24000	227	775	1622	691	2501	5523	82.6	137.2	193.2	•	0.96	XCB7018C.T.P4S		
13000	20000	319	1207	2585	937	3625	7934	196.9	318.6	427.0	•	0.96	XCB7018E.T.P4S		
12000	19000	130	389	777	386	1212	2536	66.1	103.5	141.6	•	1.31	HS7018C.T.P4S		
10000	17000	207	621	1242	592	1813	3689	164.4	244.9	318.6	•	1.31	HS7018E.T.P4S		
14000	22000	89	268	536	264	823	1706	64.7	99.3	133.3	•	1.22	HC7018C.T.P4S		
12000	19000	146	437	874	422	1278	2593	165.7	244.0	314.9	•	1.22	HC7018E.T.P4S		
18000	30000	89	268	536	264	823	1706	64.7	99.3	133.3	•	1.22	XC7018C.T.P4S		
15000	24000	146	437	874	422	1278	2593	165.7	244.0	314.9	•	1.22	XC7018E.T.P4S		
8500	14000	738	2332	4746	2308	7904	17237	109.7	185.7	267.8	–	2.26	B7218C.T.P4S		
7500	12000	1136	3717	7651	3343	11322	24113	258.6	406.9	549.2	–	2.26	B7218E.T.P4S		
11000	18000	399	1309	2691	1224	4252	9221	96.1	157.7	220.9	–	1.86	HCB7218C.T.P4S		
9000	15000	580	2021	4246	1707	6083	13095	230.4	362.8	483.7	–	1.86	HCB7218E.T.P4S		

**Direct lube design**  
Consult Barden  
(HCB7018EDLR.T.P4S.UL)

**X-life ultra design**  
**XC118HCUL**  
(XCB7018C.T.P4S.UL)

† FAG Basic Bearing Number is for reference only. All bearings are available exclusively from Barden, and must be ordered using the Barden Basic Bearing Number.

\* = speeds indicated are for spring preloads.



# SPINDLE BEARINGS

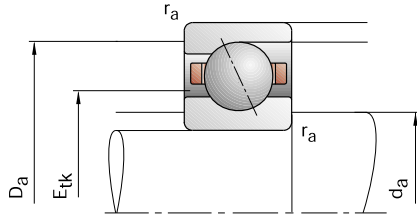

Single

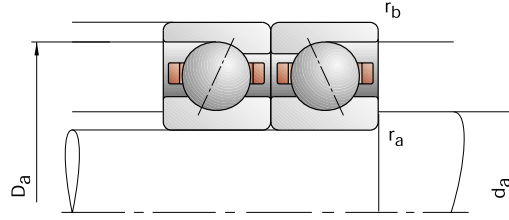

Duplex

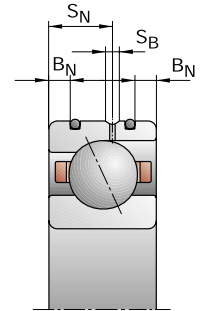

Direct Lube (DLR)

Barden Basic Bearing Number	Dimensions					Shaft & Shoulder Housing Dimensions				DLR Dimensions				Load Ratings			
	d	D	B	r <sub>smin</sub>	r <sub>1smin</sub>	d <sub>a</sub> h12	D <sub>a</sub> H12	r <sub>a</sub> max	r <sub>b</sub> max	B <sub>N</sub>	S <sub>N</sub>	S <sub>B</sub>	E <sub>tk</sub>	C <sub>dyn</sub>	C <sub>0stat</sub>		
	mm															kN	
1819HC	95	120	13	1.00	0.30	100	114.5	1.0	0.3				104.4	21.60	24.50		
1819HE	95	120	13	1.00	0.30	100	114.5	1.0	0.3				104.4	20.40	22.80		
C1819HC	95	120	13	1.00	0.30	100	114.5	1.0	0.3				104.4	15.00	17.00		
C1819HE	95	120	13	1.00	0.30	100	114.5	1.0	0.3				104.4	14.00	16.00		
1919HC	95	130	18	1.10	1.10	102	124	0.6	0.6				109.2	46.50	51.00		
1919HE	95	130	18	1.10	1.10	102	124	0.6	0.6				109.2	44.00	48.00		
C1919HC	95	130	18	1.10	1.10	102	124	0.6	0.6	4.0	10.4	2.2	109.2	32.00	35.50		
C1919HE	95	130	18	1.10	1.10	102	124	0.6	0.6	4.0	10.4	2.2	109.2	30.50	33.50		
XC1919HC	95	130	18	1.10	1.10	102	124	0.6	0.6	4.0	10.4	2.2	109.2	71.00	35.50		
XC1919HE	95	130	18	1.10	1.10	102	124	0.6	0.6	4.0	10.4	2.2	109.2	68.00	33.50		
ZSB1919C	95	130	18	1.10	1.10	102	124	0.6	0.6				109.5	24.50	30.00		
ZSB1919E	95	130	18	1.10	1.10	102	124	0.6	0.6				109.5	22.80	28.00		
CZSB1919C	95	130	18	1.10	1.10	102	124	0.6	0.6	4.0	10.4	2.2	109.5	17.00	20.80		
CZSB1919E	95	130	18	1.10	1.10	102	124	0.6	0.6	4.0	10.4	2.2	109.5	16.00	19.30		
XCZSB1919C	95	130	18	1.10	1.10	102	124	0.6	0.6	4.0	10.4	2.2	109.5	38.00	20.80		
XCZSB1919E	95	130	18	1.10	1.10	102	124	0.6	0.6	4.0	10.4	2.2	109.5	35.50	19.30		
119HC	95	145	24	1.50	1.50	105	136	1.5	0.6				113.6	78.00	76.50		
119HE	95	145	24	1.50	1.50	105	136	1.5	0.6				113.6	75.00	72.00		
C119HC	95	145	24	1.50	1.50	105	136	1.5	0.6	5.5	14.5	2.2	113.6	54.00	53.00		
C119HE	95	145	24	1.50	1.50	105	136	1.5	0.6	5.5	14.5	2.2	113.6	51.00	51.00		
XC119HC	95	145	24	1.50	1.50	105	136	1.5	0.6	5.5	14.5	2.2	113.6	120.00	53.00		
XC119HE	95	145	24	1.50	1.50	105	136	1.5	0.6	5.5	14.5	2.2	113.6	114.00	51.00		
ZSB119C	95	145	24	1.50	1.50	105	136	1.5	0.6				116.0	38.00	44.00		
ZSB119E	95	145	24	1.50	1.50	105	136	1.5	0.6				116.0	35.50	41.50		
CZSB119C	95	145	24	1.50	1.50	105	136	1.5	0.6	5.5	14.5	2.2	116.0	26.00	31.00		
CZSB119E	95	145	24	1.50	1.50	105	136	1.5	0.6	5.5	14.5	2.2	116.0	24.50	28.50		
XCZSB119C	95	145	24	1.50	1.50	105	136	1.5	0.6	5.5	14.5	2.2	116.0	58.50	31.00		
XCZSB119E	95	145	24	1.50	1.50	105	136	1.5	0.6	5.5	14.5	2.2	116.0	55.00	28.50		
219HC	95	170	32	2.10	2.10	110.5	154	2.0	2.0				125.8	127.00	114.00		
219HE	95	170	32	2.10	2.10	110.5	154	2.0	2.0				125.8	122.00	108.00		
C219HC	95	170	32	2.10	2.10	110.5	154	2.0	2.0				125.8	88.00	80.00		
C219HE	95	170	32	2.10	2.10	110.5	154	2.0	2.0				125.8	83.00	75.00		

**Designation examples:**

Barden

FAG

**Sealed design**

119HCRRUL

(B7019C.2RSD.T.P4S.UL)

**Hybrid ceramic design**

C119HCUL

(HCB7019C.T.P4S.UL)

# SPINDLE BEARINGS

## 1800HC/E, 1900HC/E, 100HC/E, 200HC/E, ZSB1900C/E, ZSB100C/E

C: Contact Angle  $\alpha = 15^\circ$  / E: Contact Angle  $\alpha = 25^\circ$

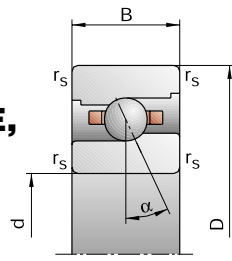

High Speed Design (ZSB)

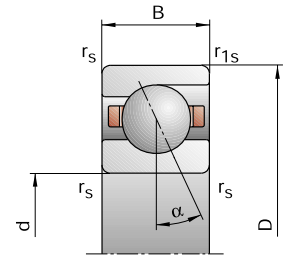

Standard Design

Attainable Speed*		Standard Preload $F_V$ (Force)			Unloading Force $K_{aE}$			Axial Rigidity $S_a$			Sealed Design	Weight	FAG Basic Bearing Number†
Grease	Oil minimal	L	M	H	L	M	H	L	M	H		kg	
min <sup>-1</sup>		N						N/μm					
10000	17000	92	343	737	278	1122	2586	60.5	107.9	158.4	–	0.29	B71819C.TPA.P4
9000	15000	111	504	1137	319	1497	3485	133.7	234.0	324.9	–	0.29	B71819E.TPA.P4
13000	20000	46	199	444	137	629	1484	52.1	94.0	135.7	–	0.29	HCB71819C.TPA.P4
11000	18000	77	267	655	222	786	1974	133.0	208.0	292.4	–	0.29	HCB71819E.TPA.P4
9500	16000	245	827	1724	755	2752	6135	84.9	145.9	211.1	•	0.58	B71919C.T.P4S
8500	14000	343	1269	2713	1002	3820	8439	196.4	320.5	436.5	•	0.58	B71919E.T.P4S
12000	19000	121	443	947	365	1415	3185	72.3	122.5	173.0	•	0.49	HCB71919C.T.P4S
10000	17000	150	663	1487	439	1982	4537	166.6	283.4	384.9	•	0.49	HCB71919E.T.P4S
16000	26000	121	443	947	365	1415	3185	72.3	122.5	173.0	•	0.49	XCB71919C.T.P4S
14000	22000	150	663	1487	439	1982	4537	166.6	283.4	384.9	•	0.49	XCB71919E.T.P4S
12000	19000	85	255	509	252	789	1651	60.8	94.8	129.4	•	0.66	HS71919C.T.P4S
10000	17000	138	414	828	395	1205	2455	152.8	226.9	295.0	•	0.66	HS71919E.T.P4S
14000	22000	59	177	354	174	541	1122	59.7	91.4	122.5	•	0.61	HC71919C.T.P4S
12000	19000	96	288	575	277	842	1704	153.1	225.5	290.4	•	0.61	HC71919E.T.P4S
18000	30000	59	177	354	174	541	1122	59.7	91.4	122.5	•	0.61	XC71919C.T.P4S
16000	26000	96	288	575	277	842	1704	153.1	225.5	290.4	•	0.61	XC71919E.T.P4S
9000	15000	447	1452	2980	1388	4880	10731	99.4	169.3	244.3	•	1.20	B7019C.T.P4S
8000	13000	675	2308	4813	1981	7005	15060	234.4	373.7	505.1	•	1.20	B7019E.T.P4S
11000	18000	238	811	1692	724	2617	5757	86.7	144.1	202.4	•	1.01	HCB7019C.T.P4S
9500	16000	325	1231	2641	954	3694	8096	204.9	331.4	444.1	•	1.01	HCB7019E.T.P4S
15000	24000	238	811	1692	724	2617	5757	86.7	144.1	202.4	•	1.01	XCB7019C.T.P4S
13000	20000	325	1231	2641	954	3694	8096	204.9	331.4	444.1	•	1.01	XCB7019E.T.P4S
11000	18000	130	389	777	385	1210	2529	67.4	105.5	144.1	•	1.34	HS7019C.T.P4S
9500	16000	211	633	1265	604	1847	3756	169.3	251.8	327.5	•	1.34	HS7019E.T.P4S
13000	20000	89	268	536	263	822	1702	65.9	101.3	135.7	•	1.24	HC7019C.T.P4S
11000	18000	146	437	874	422	1277	2591	169.3	249.1	321.4	•	1.25	HC7019E.T.P4S
17000	28000	89	268	536	263	822	1702	65.9	101.3	135.7	•	1.24	XC7019C.T.P4S
14000	22000	146	437	874	422	1277	2591	169.3	249.1	321.4	•	1.25	XC7019E.T.P4S
8000	13000	768	2426	4937	2398	8203	17878	115.7	195.6	281.8	–	2.78	B7219C.T.P4S
7000	11000	1193	3906	8042	3509	11890	25320	274.2	431.5	582.0	–	2.78	B7219E.T.P4S
10000	17000	411	1353	2784	1258	4384	9513	101.0	165.9	232.1	–	2.36	HCB7219C.T.P4S
8500	14000	598	2092	4400	1759	6291	13552	242.8	382.6	510.0	–	2.36	HCB7219E.T.P4S

**Direct lube design**  
Consult Barden  
(HCB7019EDLR.T.P4S.UL)

**X-life ultra design**  
**XC119HCUL**  
(XCB7019C.T.P4S.UL)

† FAG Basic Bearing Number is for reference only. All bearings are available exclusively from Barden, and must be ordered using the Barden Basic Bearing Number.

\* = speeds indicated are for spring preloads.



# SPINDLE BEARINGS

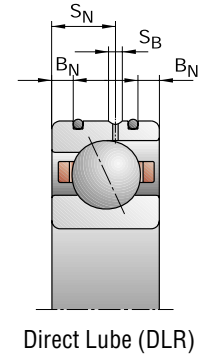
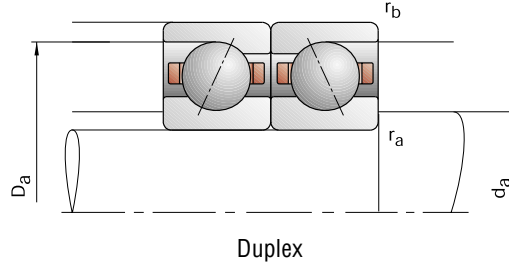
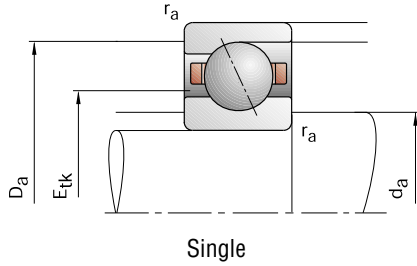

Barden Basic Bearing Number	Dimensions					Shaft & Shoulder Housing Dimensions				DLR Dimensions				Load Ratings			
	d	D	B	r <sub>smin</sub>	r <sub>1smin</sub>	d <sub>a</sub> h12	D <sub>a</sub> H12	r <sub>a</sub> max	r <sub>b</sub> max	B <sub>N</sub>	S <sub>N</sub>	S <sub>B</sub>	E <sub>tk</sub>	C <sub>dyn</sub>	C <sub>0stat</sub>		
	mm															kN	
1820HC	100	125	13	1.00	0.30	105	119.5	1.0	0.3				109.4	21.60	25.00		
1820HE	100	125	13	1.00	0.30	105	119.5	1.0	0.3				109.4	20.40	23.60		
C1820HC	100	125	13	1.00	0.30	105	119.5	1.0	0.3				109.4	15.00	17.60		
C1820HE	100	125	13	1.00	0.30	105	119.5	1.0	0.3				109.4	14.00	16.30		
1920HC	100	140	20	1.10	1.10	107	133	0.6	0.6				117.2	58.50	64.00		
1920HE	100	140	20	1.10	1.10	107	133	0.6	0.6				117.2	55.00	60.00		
C1920HC	100	140	20	1.10	1.10	107	133	0.6	0.6	4.0	12.0	2.2	117.2	40.50	44.00		
C1920HE	100	140	20	1.10	1.10	107	133	0.6	0.6	4.0	12.0	2.2	117.2	38.00	42.50		
XC1920HC	100	140	20	1.10	1.10	107	133	0.6	0.6	4.0	12.0	2.2	117.2	90.00	44.00		
XC1920HE	100	140	20	1.10	1.10	107	133	0.6	0.6	4.0	12.0	2.2	117.2	85.00	42.50		
ZSB1920C	100	140	20	1.10	1.10	107	133	0.6	0.6				116.7	29.00	36.00		
ZSB1920E	100	140	20	1.10	1.10	107	133	0.6	0.6				116.7	27.50	33.50		
CZSB1920C	100	140	20	1.10	1.10	107	133	0.6	0.6	4.0	12.0	2.2	116.7	20.40	25.00		
CZSB1920E	100	140	20	1.10	1.10	107	133	0.6	0.6	4.0	12.0	2.2	116.7	19.00	23.60		
XCZSB1920C	100	140	20	1.10	1.10	107	133	0.6	0.6	4.0	12.0	2.2	116.7	45.50	25.00		
XCZSB1920E	100	140	20	1.10	1.10	107	133	0.6	0.6	4.0	12.0	2.2	116.7	42.50	23.60		
120HC	100	150	24	1.50	1.50	110	141	1.5	0.6				118.6	81.50	81.50		
120HE	100	150	24	1.50	1.50	110	141	1.5	0.6				118.6	76.50	76.50		
C120HC	100	150	24	1.50	1.50	110	141	1.5	0.6	5.5	14.5	2.2	118.6	56.00	56.00		
C120HE	100	150	24	1.50	1.50	110	141	1.5	0.6	5.5	14.5	2.2	118.6	53.00	53.00		
XC120HC	100	150	24	1.50	1.50	110	141	1.5	0.6	5.5	14.5	2.2	118.6	125.00	56.00		
XC120HE	100	150	24	1.50	1.50	110	141	1.5	0.6	5.5	14.5	2.2	118.6	118.00	53.00		
ZSB120C	100	150	24	1.50	1.50	110	141	1.5	0.6				121.0	38.00	45.50		
ZSB120E	100	150	24	1.50	1.50	110	141	1.5	0.6				121.0	36.00	42.50		
CZSB120C	100	150	24	1.50	1.50	110	141	1.5	0.6	5.5	14.5	2.2	121.0	26.50	31.50		
CZSB120E	100	150	24	1.50	1.50	110	141	1.5	0.6	5.5	14.5	2.2	121.0	25.00	30.00		
XCZSB120C	100	150	24	1.50	1.50	110	141	1.5	0.6	5.5	14.5	2.2	121.0	58.50	31.50		
XCZSB120E	100	150	24	1.50	1.50	110	141	1.5	0.6	5.5	14.5	2.2	121.0	56.00	30.00		
220HC	100	180	34	2.10	2.10	114.5	165.5	2.1	2.1				132.4	132.00	122.00		
220HE	100	180	34	2.10	2.10	114.5	165.5	2.1	2.1				132.4	125.00	116.00		
C220HC	100	180	34	2.10	2.10	114.5	165.5	2.1	2.1				132.4	91.50	85.00		
C220HE	100	180	34	2.10	2.10	114.5	165.5	2.1	2.1				132.4	86.50	81.50		

**Designation examples:**

Barden

FAG

**Sealed design**

120HCRRUL

(B7020C.2RSD.T.P4S.UL)

**Hybrid ceramic design**

C120HCUL

(HCB7020C.T.P4S.UL)

# SPINDLE BEARINGS

## 1800HC/E, 1900HC/E, 100HC/E, 200HC/E, ZSB1900C/E, ZSB100C/E

C: Contact Angle  $\alpha = 15^\circ$  / E: Contact Angle  $\alpha = 25^\circ$

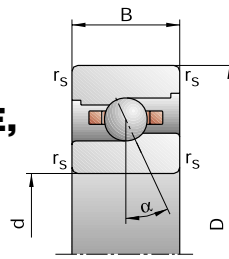

High Speed Design (ZSB)

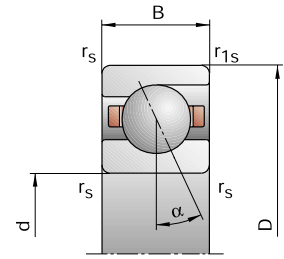

Standard Design

Attainable Speed*		Standard Preload $F_V$ (Force)			Unloading Force $K_{aE}$			Axial Rigidity $S_a$			Sealed Design	Weight	FAG Basic Bearing Number†
Grease	Oil minimal	L	M	H	L	M	H	L	M	H		kg	
min <sup>-1</sup>		N											
		N/μm											
9500	16000	91	341	735	274	1112	2570	61.2	109.4	160.6	–	0.30	B71820C.TPA.P4
8500	14000	109	500	1132	313	1483	3464	135.5	237.9	330.4	–	0.30	B71820E.TPA.P4
12000	19000	46	203	454	136	641	1517	52.8	96.5	139.5	–	0.30	HCB71820C.TPA.P4
10000	17000	79	272	669	228	801	2016	137.2	213.8	300.7	–	0.30	HCB71820E.TPA.P4
9000	15000	318	1059	2194	980	3524	7827	94.6	161.7	233.7	•	0.79	B71920C.T.P4S
8000	13000	453	1626	3437	1323	4902	10706	219.8	355.1	481.6	•	0.79	B71920E.T.P4S
11000	18000	161	576	1220	488	1841	4106	81.4	136.6	192.3	•	0.66	HCB71920C.T.P4S
9500	16000	204	852	1881	596	2544	5745	188.0	313.9	424.3	•	0.66	HCB71920E.T.P4S
15000	24000	161	576	1220	488	1841	4106	81.4	136.6	192.3	•	0.66	XCB71920C.T.P4S
12000	19000	204	852	1881	596	2544	5745	188.0	313.9	424.3	•	0.66	XCB71920E.T.P4S
11000	18000	102	306	611	301	947	1978	65.5	102.4	139.7	•	0.90	HS71920C.T.P4S
9500	16000	166	497	994	476	1447	2950	165.5	245.4	319.2	•	0.90	HS71920E.T.P4S
13000	20000	70	209	418	207	639	1324	64.4	98.3	131.5	•	0.84	HC71920C.T.P4S
11000	18000	115	345	690	332	1009	2046	165.4	243.6	314.1	•	0.84	HC71920E.T.P4S
17000	28000	70	209	418	207	639	1324	64.4	98.3	131.5	•	0.84	XC71920C.T.P4S
14000	22000	115	345	690	332	1009	2046	165.4	243.6	314.1	•	0.84	XC71920E.T.P4S
8500	14000	467	1516	3112	1450	5092	11199	104.1	177.2	255.8	•	1.26	B7020C.T.P4S
7500	12000	685	2347	4902	2009	7114	15314	243.1	387.4	523.6	•	1.26	B7020E.T.P4S
11000	18000	238	818	1707	723	2632	5787	89.4	148.6	208.5	•	1.05	HCB7020C.T.P4S
9000	15000	334	1272	2731	980	3815	8366	213.5	345.9	463.5	•	1.05	HCB7020E.T.P4S
14000	22000	238	818	1707	723	2632	5787	89.4	148.6	208.5	•	1.05	XCB7020C.T.P4S
12000	19000	334	1272	2731	980	3815	8366	213.5	345.9	463.5	•	1.05	XCB7020E.T.P4S
11000	18000	134	402	804	397	1250	2618	69.5	108.9	149.0	•	1.40	HS7020C.T.P4S
9000	15000	215	644	1288	615	1879	3822	173.9	258.6	336.2	•	1.40	HS7020E.T.P4S
12000	19000	91	273	547	269	837	1736	67.8	104.0	139.4	•	1.29	HC7020C.T.P4S
11000	18000	148	444	888	428	1297	2631	173.8	255.7	329.8	•	1.29	HC7020E.T.P4S
16000	26000	91	273	547	269	837	1736	67.8	104.0	139.4	•	1.29	XC7020C.T.P4S
14000	22000	148	444	888	428	1297	2631	173.8	255.7	329.8	•	1.29	XC7020E.T.P4S
7500	12000	796	2519	5128	2482	8499	18521	121.7	205.5	295.8	–	3.32	B7220C.T.P4S
6700	10000	1217	3994	8229	3576	12137	25856	287.0	451.4	608.5	–	3.32	B7220E.T.P4S
9500	16000	428	1408	2898	1309	4556	9884	106.4	174.6	244.2	–	2.87	HCB7220C.T.P4S
8000	13000	623	2181	5427	1832	6554	16724	256.2	403.6	548.1	–	2.87	HCB7220E.T.P4S

**Direct lube design**  
Consult Barden  
(HCB7020EDLR.T.P4S.UL)

**X-life ultra design**  
**XC120HCUL**  
(XCB7020C.T.P4S.UL)

† FAG Basic Bearing Number is for reference only. All bearings are available exclusively from Barden, and must be ordered using the Barden Basic Bearing Number.

\* = speeds indicated are for spring preloads.



# SPINDLE BEARINGS

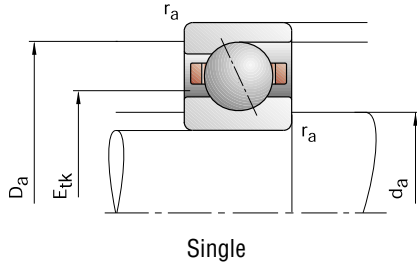

Single

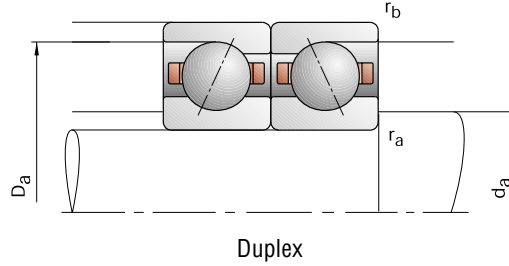

Duplex

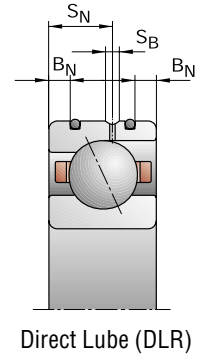

Direct Lube (DLR)

Barden Basic Bearing Number	Dimensions					Shaft & Shoulder Housing Dimensions				DLR Dimensions				Load Ratings			
	d	D	B	r <sub>smin</sub>	r <sub>1smin</sub>	d <sub>a</sub> h12	D <sub>a</sub> H12	r <sub>a</sub> max	r <sub>b</sub> max	B <sub>N</sub>	S <sub>N</sub>	S <sub>B</sub>	E <sub>tk</sub>	C <sub>dyn</sub>	C <sub>0stat</sub>		
	mm															kN	
1821HC	105	130	13	1.00	0.30	110	124.5	1.0	0.3				114.4	22.80	27.50		
1821HE	105	130	13	1.00	0.30	110	124.5	1.0	0.3				114.4	21.60	25.50		
C1821HC	105	130	13	1.00	0.30	110	124.5	1.0	0.3				114.4	15.60	19.00		
C1821HE	105	130	13	1.00	0.30	110	124.5	1.0	0.3				114.4	15.00	18.00		
1921HC	105	145	20	1.10	1.10	112	138	0.6	0.6				121.2	58.50	64.00		
1921HE	105	145	20	1.10	1.10	112	138	0.6	0.6				121.2	55.00	60.00		
C1921HC	105	145	20	1.10	1.10	112	138	0.6	0.6	4.0	12.0	2.2	121.2	40.00	45.00		
C1921HE	105	145	20	1.10	1.10	112	138	0.6	0.6	4.0	12.0	2.2	121.2	38.00	42.50		
XC1921HC	105	145	20	1.10	1.10	112	138	0.6	0.6	4.0	12.0	2.2	121.2	90.00	45.00		
XC1921HE	105	145	20	1.10	1.10	112	138	0.6	0.6	4.0	12.0	2.2	121.2	85.00	42.50		
ZSB1921C	105	145	20	1.10	1.10	112	138	0.6	0.6				121.7	30.00	38.00		
ZSB1921E	105	145	20	1.10	1.10	112	138	0.6	0.6				121.7	28.00	35.50		
CZSB1921C	105	145	20	1.10	1.10	112	138	0.6	0.6	4.0	12.0	2.2	121.7	20.80	26.50		
CZSB1921E	105	145	20	1.10	1.10	112	138	0.6	0.6	4.0	12.0	2.2	121.7	19.60	24.50		
XCZSB1921C	105	145	20	1.10	1.10	112	138	0.6	0.6	4.0	12.0	2.2	121.7	46.50	26.50		
XCZSB1921E	105	145	20	1.10	1.10	112	138	0.6	0.6	4.0	12.0	2.2	121.7	44.00	24.50		
121HC	105	160	26	2.00	2.00	116	150	2.0	1.0				125.8	106.00	102.00		
121HE	105	160	26	2.00	2.00	116	150	2.0	1.0				125.8	102.00	98.00		
C121HC	105	160	26	2.00	2.00	116	150	2.0	1.0	6.0	15.2	2.2	125.8	73.50	72.00		
C121HE	105	160	26	2.00	2.00	116	150	2.0	1.0	6.0	15.2	2.2	125.8	69.50	68.00		
XC121HC	105	160	26	2.00	2.00	116	150	2.0	1.0	6.0	15.2	2.2	125.8	163.00	72.00		
XC121HE	105	160	26	2.00	2.00	116	150	2.0	1.0	6.0	15.2	2.2	125.8	156.00	68.00		
ZSB121C	105	160	26	2.00	2.00	116	150	2.0	1.0				127.9	49.00	58.50		
ZSB121E	105	160	26	2.00	2.00	116	150	2.0	1.0				127.9	46.50	54.00		
CZSB121C	105	160	26	2.00	2.00	116	150	2.0	1.0	6.0	15.2	2.2	127.9	34.00	40.50		
CZSB121E	105	160	26	2.00	2.00	116	150	2.0	1.0	6.0	15.2	2.2	127.9	32.00	38.00		
XCZSB121C	105	160	26	2.00	2.00	116	150	2.0	1.0	6.0	15.2	2.2	127.9	76.50	40.50		
XCZSB121E	105	160	26	2.00	2.00	116	150	2.0	1.0	6.0	15.2	2.2	127.9	71.00	38.00		
221HC	105	190	36	2.10	2.10	120.5	174.5	2.1	2.1				139.9	163.00	146.00		
221HE	105	190	36	2.10	2.10	120.5	174.5	2.1	2.1				139.9	156.00	140.00		
C221HC	105	190	36	2.10	2.10	120.5	174.5	2.1	2.1				139.9	112.00	102.00		
C221HE	105	190	36	2.10	2.10	120.5	174.5	2.1	2.1				139.9	106.00	98.00		

**Designation examples:**

Barden

FAG

**Sealed design**

121HCRRUL

(B7021C.2RSD.T.P4S.UL)

**Hybrid ceramic design**

C121HCUL

(HCB7021C.T.P4S.UL)



# SPINDLE BEARINGS

## 1800HC/E, 1900HC/E, 100HC/E, 200HC/E, ZSB1900C/E, ZSB100C/E

C: Contact Angle  $\alpha = 15^\circ$  / E: Contact Angle  $\alpha = 25^\circ$

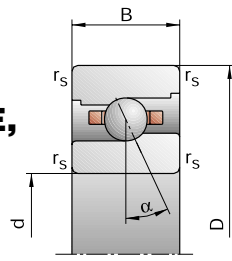

High Speed Design (ZSB)

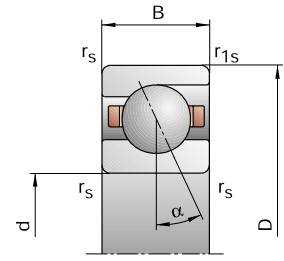

Standard Design

Attainable Speed*		Standard Preload $F_V$ (Force)			Unloading Force $K_{aE}$			Axial Rigidity $S_a$			Sealed Design	Weight	FAG Basic Bearing Number†
Grease	Oil minimal	L	M	H	L	M	H	L	M	H		kg	
min <sup>-1</sup>		N											
		N/μm											
9000	15000	95	358	774	286	1164	2696	65.9	117.3	172.2	–	0.3	B71821C.TPA.P4
8000	13000	112	525	1193	321	1555	3644	144.8	256.0	355.8	–	0.3	B71821E.TPA.P4
12000	19000	47	209	470	139	658	1563	56.4	102.9	148.6	–	0.3	HCB71821C.TPA.P4
10000	17000	80	278	686	231	817	2062	146.2	227.9	320.5	–	0.3	HCB71821E.TPA.P4
8500	14000	318	1059	2194	980	3524	7826	94.6	161.7	233.7	•	0.8	B71921C.T.P4S
7500	12000	453	1626	3437	1323	4902	10705	219.8	355.1	481.6	•	0.8	B71921E.T.P4S
11000	18000	161	576	1220	487	1840	4105	81.2	136.6	192.3	•	0.7	HCB71921C.T.P4S
9000	15000	204	852	1881	596	2543	5745	188.0	313.8	424.3	•	0.7	HCB71921E.T.P4S
14000	22000	161	576	1220	487	1840	4105	81.2	136.6	192.3	•	0.7	XCB71921C.T.P4S
12000	19000	204	852	1881	596	2543	5745	188.0	313.8	424.3	•	0.7	XCB71921E.T.P4S
11000	18000	104	311	622	307	961	2008	68.3	106.4	144.9	•	0.9	HS71921C.T.P4S
9000	15000	169	506	1012	484	1472	2999	172.2	255.3	331.8	•	0.9	HS71921E.T.P4S
12000	19000	71	214	429	209	653	1357	66.7	102.3	137.0	•	0.9	HC71921C.T.P4S
11000	18000	117	352	704	337	1029	2086	171.9	253.8	327.1	•	0.9	HC71921E.T.P4S
16000	26000	71	214	429	209	653	1357	66.7	102.3	137.0	•	0.9	XC71921C.T.P4S
14000	22000	117	352	704	337	1029	2086	171.9	253.8	327.1	•	0.9	XC71921E.T.P4S
8000	13000	625	1999	4083	1942	6714	14681	114.3	193.4	278.6	•	1.6	B7021C.T.P4S
7000	11000	960	3206	6639	2816	9723	20806	270.9	428.4	578.2	•	1.6	B7021E.T.P4S
10000	17000	337	1125	2328	1028	3629	7914	100.3	165.2	231.3	•	1.3	HCB7021C.T.P4S
8500	14000	470	1703	3618	1383	5119	11103	238.4	379.6	506.8	•	1.3	HCB7021E.T.P4S
13000	20000	337	1125	2328	1028	3629	7914	100.3	165.2	231.3	•	1.3	XCB7021C.T.P4S
11000	18000	470	1703	3618	1383	5119	11103	238.4	379.6	506.8	•	1.3	XCB7021E.T.P4S
10000	17000	170	509	1018	504	1580	3317	75.9	118.7	162.4	•	1.8	HS7021C.T.P4S
8500	14000	276	828	1656	790	2412	4919	190.6	283.4	368.9	•	1.8	HS7021E.T.P4S
12000	19000	118	355	710	350	1088	2259	74.8	114.6	153.8	•	1.6	HC7021C.T.P4S
10000	17000	192	575	1150	555	1682	3412	191.0	281.3	362.9	•	1.6	HC7021E.T.P4S
15000	24000	118	355	710	350	1088	2259	74.8	114.6	153.8	•	1.6	XC7021C.T.P4S
13000	21000	192	575	1150	555	1682	3412	191.0	281.3	362.9	•	1.6	XC7021E.T.P4S
7000	11000	997	3140	6377	3116	10597	23098	132.0	222.4	320.4	–	4.0	B7221C.T.P4S
6300	9500	1558	5040	10337	4587	15335	32479	313.5	490.7	660.3	–	4.0	B7221E.T.P4S
9000	15000	535	1734	3559	1635	5604	12126	115.2	187.9	262.4	–	3.3	HCB7221C.T.P4S
7500	12000	805	2756	5751	2371	8297	17714	280.6	438.8	583.1	–	3.3	HCB7221E.T.P4S

**Direct lube design**  
Consult Barden  
(HCB7021EDLR.T.P4S.UL)

**X-life ultra design**  
**XC121HCUL**  
(XCB7021C.T.P4S.UL)

† FAG Basic Bearing Number is for reference only. All bearings are available exclusively from Barden, and must be ordered using the Barden Basic Bearing Number.

\* = speeds indicated are for spring preloads.



# SPINDLE BEARINGS

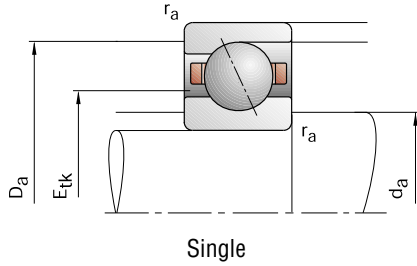

Single

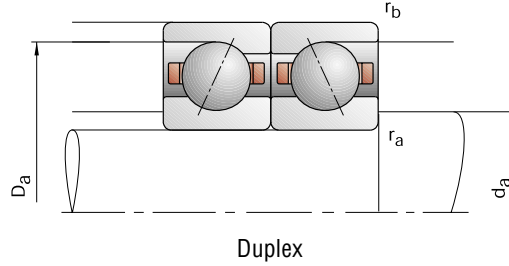

Duplex

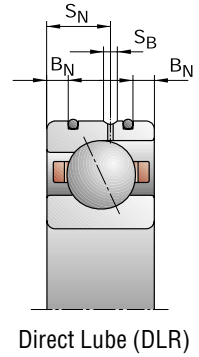

Direct Lube (DLR)

Barden Basic Bearing Number	Dimensions					Shaft & Shoulder Housing Dimensions				DLR Dimensions				Load Ratings			
	d	D	B	r <sub>smin</sub>	r <sub>1smin</sub>	d <sub>a</sub> h12	D <sub>a</sub> H12	r <sub>a</sub> max	r <sub>b</sub> max	B <sub>N</sub>	S <sub>N</sub>	S <sub>B</sub>	E <sub>tk</sub>	C <sub>dyn</sub>	C <sub>0stat</sub>		
	mm															kN	
1822HC	110	140	16	1.00	0.30	116	133.5	1.0	0.3				121.2	31.50	36.50		
1822HE	110	140	16	1.00	0.30	116	133.5	1.0	0.3				121.2	29.00	34.00		
C1822HC	110	140	16	1.00	0.30	116	133.5	1.0	0.3				121.2	21.60	25.50		
C1822HE	110	140	16	1.00	0.30	116	133.5	1.0	0.3				121.2	20.40	24.00		
1922HC	110	150	20	1.10	1.10	117	143	0.6	0.6				126.2	58.50	67.00		
1922HE	110	150	20	1.10	1.10	117	143	0.6	0.6				126.2	56.00	63.00		
C1922HC	110	150	20	1.10	1.10	117	143	0.6	0.6	4.0	12.0	2.2	126.2	40.50	46.50		
C1922HE	110	150	20	1.10	1.10	117	143	0.6	0.6	4.0	12.0	2.2	126.2	39.00	44.00		
XC1922HC	110	150	20	1.10	1.10	117	143	0.6	0.6	4.0	12.0	2.2	126.2	90.00	46.50		
XC1922HE	110	150	20	1.10	1.10	117	143	0.6	0.6	4.0	12.0	2.2	126.2	86.50	44.00		
ZSB1922C	110	150	20	1.10	1.10	117	143	0.6	0.6				126.4	34.50	44.00		
ZSB1922E	110	150	20	1.10	1.10	117	143	0.6	0.6				126.4	32.50	40.50		
CZSB1922C	110	150	20	1.10	1.10	117	143	0.6	0.6	4.0	12.0	2.2	126.4	24.00	30.50		
CZSB1922E	110	150	20	1.10	1.10	117	143	0.6	0.6	4.0	12.0	2.2	126.4	22.80	28.50		
XCZSB1922C	110	150	20	1.10	1.10	117	143	0.6	0.6	4.0	12.0	2.2	126.4	54.00	30.50		
XCZSB1922E	110	150	20	1.10	1.10	117	143	0.6	0.6	4.0	12.0	2.2	126.4	51.00	28.50		
122HC	110	170	28	2.00	2.00	121	159	2.0	1.0				133.3	110.00	110.00		
122HE	110	170	28	2.00	2.00	121	159	2.0	1.0				133.3	104.00	104.00		
C122HC	110	170	28	2.00	2.00	121	159	2.0	1.0	6.0	16.2	2.2	133.3	75.00	76.50		
C122HE	110	170	28	2.00	2.00	121	159	2.0	1.0	6.0	16.2	2.2	133.3	72.00	72.00		
XC122HC	110	170	28	2.00	2.00	121	159	2.0	1.0	6.0	16.2	2.2	133.3	166.00	76.50		
XC122HE	110	170	28	2.00	2.00	121	159	2.0	1.0	6.0	16.2	2.2	133.3	160.00	72.00		
ZSB122C	110	170	28	2.00	2.00	121	159	2.0	1.0				135.4	50.00	60.00		
ZSB122E	110	170	28	2.00	2.00	121	159	2.0	1.0				135.4	46.50	56.00		
CZSB122C	110	170	28	2.00	2.00	121	159	2.0	1.0	6.0	16.2	2.2	135.4	34.50	41.50		
CZSB122E	110	170	28	2.00	2.00	121	159	2.0	1.0	6.0	16.2	2.2	135.4	32.50	39.00		
XCZSB122C	110	170	28	2.00	2.00	121	159	2.0	1.0	6.0	16.2	2.2	135.4	76.50	41.50		
XCZSB122E	110	170	28	2.00	2.00	121	159	2.0	1.0	6.0	16.2	2.2	135.4	72.00	39.00		
222HC	110	200	38	2.10	2.10	126.5	183.5	2.1	2.1				147.4	163.00	150.00		
222HE	110	200	38	2.10	2.10	126.5	183.5	2.1	2.1				147.4	153.00	143.00		
C222HC	110	200	38	2.10	2.10	126.5	183.5	2.1	2.1				147.4	112.00	104.00		
C222HE	110	200	38	2.10	2.10	126.5	183.5	2.1	2.1				147.4	106.00	98.00		

**Designation examples:**

Barden

FAG

**Sealed design**

122HCRRUL

(B7022C.2RSD.T.P4S.UL)

**Hybrid ceramic design**

C122HCUL

(HCB7022C.T.P4S.UL)

# SPINDLE BEARINGS

## 1800HC/E, 1900HC/E, 100HC/E, 200HC/E, ZSB1900C/E, ZSB100C/E

C: Contact Angle  $\alpha = 15^\circ$  / E: Contact Angle  $\alpha = 25^\circ$

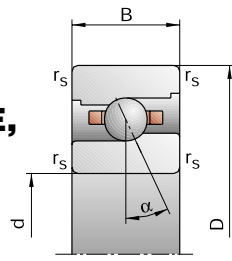

High Speed Design (ZSB)

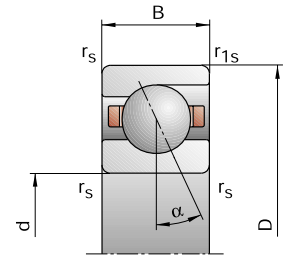

Standard Design



Attainable Speed*		Standard Preload $F_V$ (Force)			Unloading Force $K_{aE}$			Axial Rigidity $S_a$			Sealed Design	Weight	FAG Basic Bearing Number†
Grease	Oil minimal	L	M	H	L	M	H	L	M	H		kg	
min <sup>-1</sup>		N											
		N/μm											
8500	14000	146	521	1105	445	1721	3917	77.1	135.8	198.7	–	0.5	B71822C.TPA.P4
7500	12000	181	757	1673	522	2259	5156	170.6	291.1	401.7	–	0.5	B71822E.TPA.P4
11000	18000	79	315	690	237	1006	2334	68.0	120.1	172.8	–	0.5	HCB71822C.TPA.P4
9000	15000	83	445	1042	240	1320	3173	147.3	268.8	372.7	–	0.5	HCB71822E.TPA.P4
8000	13000	316	1056	2191	972	3501	7781	96.5	164.8	237.9	•	0.8	B71922C.T.P4S
7500	12000	458	1651	3495	1337	4973	10873	226.3	365.8	496.2	•	0.8	B71922E.T.P4S
10000	17000	163	583	1236	493	1860	4150	83.7	140.4	197.5	•	0.7	HCB71922C.T.P4S
9000	15000	205	861	1905	599	2569	5813	193.3	323.0	436.8	•	0.7	HCB71922E.T.P4S
13000	20000	163	583	1236	493	1860	4150	83.7	140.4	197.5	•	0.7	XCB71922C.T.P4S
11000	18000	205	861	1905	599	2569	5813	193.3	323.0	436.8	•	0.7	XCB71922E.T.P4S
10000	17000	121	362	724	357	1120	2342	71.5	111.7	152.3	•	1.0	HS71922C.T.P4S
8500	14000	196	587	1173	560	1709	3480	180.2	267.6	347.7	•	1.0	HS71922E.T.P4S
12000	19000	83	249	498	245	761	1573	70.2	107.4	143.6	•	0.9	HC71922C.T.P4S
10000	17000	135	405	810	390	1185	2395	180.2	265.2	341.3	•	0.9	HC71922E.T.P4S
15000	24000	83	249	498	245	761	1573	70.2	107.4	143.6	•	0.9	XC71922C.T.P4S
13000	20000	135	405	810	390	1185	2395	180.2	265.2	341.3	•	0.9	XC71922E.T.P4S
7500	12000	648	2072	4235	2011	6949	15201	119.6	202.1	290.9	•	2.0	B7022C.T.P4S
6700	10000	975	3262	6760	2857	9878	21147	281.3	444.8	600.0	•	2.0	B7022E.T.P4S
9500	16000	340	1140	2363	1035	3667	8007	103.8	170.9	239.2	•	1.7	HCB7022C.T.P4S
8000	13000	479	1742	3707	1408	5232	11364	248.0	395.3	527.8	•	1.7	HCB7022E.T.P4S
12000	19000	340	1140	2363	1035	3667	8007	103.8	170.9	239.2	•	1.7	XCB7022C.T.P4S
10000	17000	479	1742	3707	1408	5232	11364	248.0	395.3	527.8	•	1.7	XCB7022E.T.P4S
9500	16000	174	523	1045	516	1623	3403	78.2	122.3	167.3	•	2.2	HS7022C.T.P4S
8000	13000	280	840	1679	802	2446	4984	195.8	290.9	378.4	•	2.2	HS7022E.T.P4S
11000	18000	118	355	710	349	1086	2254	76.2	116.8	156.6	•	2.1	HC7022C.T.P4S
9000	15000	192	575	1150	555	1681	3409	195.2	287.3	370.4	•	2.1	HC7022E.T.P4S
14000	22000	118	355	710	349	1086	2254	76.2	116.8	156.6	•	2.1	XC7022C.T.P4S
12000	19000	192	575	1150	555	1681	3409	195.2	287.3	370.4	•	2.1	XC7022E.T.P4S
6700	10000	997	3139	6376	3115	10591	23087	132.0	222.4	320.3	–	4.7	B7222C.T.P4S
6000	9000	1525	4939	10131	4487	15015	31793	311.0	486.8	654.6	–	4.7	B7222E.T.P4S
8500	14000	535	1734	3558	1635	5602	12118	115.2	187.8	262.3	–	4.0	HCB7222C.T.P4S
7000	11000	789	2705	5648	2322	8137	17383	278.5	435.7	578.9	–	4.0	HCB7222E.T.P4S

**Direct lube design**  
Consult Barden  
(HCB7022EDLR.T.P4S.UL)

**X-life ultra design**  
**XC122HCUL**  
(XCB7022C.T.P4S.UL)

† FAG Basic Bearing Number is for reference only. All bearings are available exclusively from Barden, and must be ordered using the Barden Basic Bearing Number.

\* = speeds indicated are for spring preloads.

# SPINDLE BEARINGS

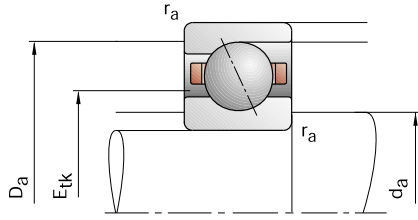

Single

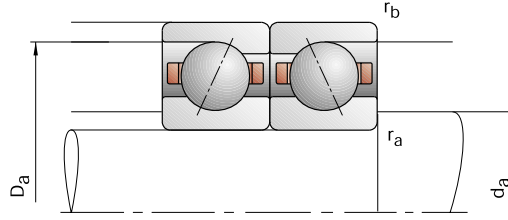

Duplex

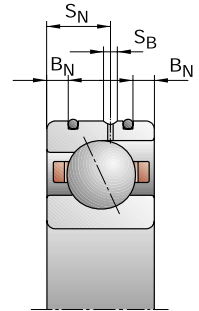

Direct Lube (DLR)

Barden Basic Bearing Number	Dimensions					Shaft & Shoulder Housing Dimensions				DLR Dimensions				Load Ratings		
	d	D	B	r <sub>smin</sub>	r <sub>1smin</sub>	d <sub>a</sub>	D <sub>a</sub>	r <sub>a</sub>	r <sub>b</sub>	B <sub>N</sub>	S <sub>N</sub>	S <sub>B</sub>	E <sub>tk</sub>	C <sub>dyn</sub>	C <sub>0stat</sub>	
	mm															kN
1824HC	120	150	16	1.00	0.30	126	143.5	1.0	0.3				131.2	32.00	39.00	
1824HE	120	150	16	1.00	0.30	126	143.5	1.0	0.3				131.2	30.00	36.00	
C1824HC	120	150	16	1.00	0.30	126	143.5	1.0	0.3				131.2	22.00	27.00	
C1824HE	120	150	16	1.00	0.30	126	143.5	1.0	0.3				131.2	20.80	25.00	
1924HC	120	165	22	1.10	1.10	128	157	0.6	0.6				138.2	73.50	85.00	
1924HE	120	165	22	1.10	1.10	128	157	0.6	0.6				138.2	69.50	80.00	
C1924HC	120	165	22	1.10	1.10	128	157	0.6	0.6				138.2	51.00	58.50	
C1924HE	120	165	22	1.10	1.10	128	157	0.6	0.6				138.2	48.00	55.00	
XC1924HC	120	165	22	1.10	1.10	128	157	0.6	0.6				138.2	114.00	58.50	
XC1924HE	120	165	22	1.10	1.10	128	157	0.6	0.6				138.2	108.00	55.00	
ZSB1924C	120	165	22	1.10	1.10	128	157	0.6	0.6				138.9	36.50	48.00	
ZSB1924E	120	165	22	1.10	1.10	128	157	0.6	0.6				138.9	34.00	45.00	
CZSB1924C	120	165	22	1.10	1.10	128	157	0.6	0.6				138.9	25.00	33.50	
CZSB1924E	120	165	22	1.10	1.10	128	157	0.6	0.6				138.9	23.60	31.00	
XCZSB1924C	120	165	22	1.10	1.10	128	157	0.6	0.6				138.9	56.00	33.50	
XCZSB1924E	120	165	22	1.10	1.10	128	157	0.6	0.6				138.9	53.00	31.00	
124HC	120	180	28	2.00	2.00	131	169	2.0	1.0				143.3	112.00	116.00	
124HE	120	180	28	2.00	2.00	131	169	2.0	1.0				143.3	106.00	110.00	
C124HC	120	180	28	2.00	2.00	131	169	2.0	1.0				143.3	78.00	81.50	
C124HE	120	180	28	2.00	2.00	131	169	2.0	1.0				143.3	73.50	76.50	
XC124HC	120	180	28	2.00	2.00	131	169	2.0	1.0				143.3	173.00	81.50	
XC124HE	120	180	28	2.00	2.00	131	169	2.0	1.0				143.3	163.00	76.50	
ZSB124C	120	180	28	2.00	2.00	131	169	2.0	1.0				145.4	51.00	63.00	
ZSB124E	120	180	28	2.00	2.00	131	169	2.0	1.0				145.4	48.00	58.50	
CZSB124C	120	180	28	2.00	2.00	131	169	2.0	1.0				145.4	35.50	44.00	
CZSB124E	120	180	28	2.00	2.00	131	169	2.0	1.0				145.4	33.50	41.50	
XCZSB124C	120	180	28	2.00	2.00	131	169	2.0	1.0				145.4	80.00	44.00	
XCZSB124E	120	180	28	2.00	2.00	131	169	2.0	1.0				145.4	75.00	41.50	
224HC	120	215	40	2.10	2.10	140	195	2.1	2.1				158.0	204.00	196.00	
224HE	120	215	40	2.10	2.10	140	195	2.1	2.1				158.0	196.00	186.00	
C224HC	120	215	40	2.10	2.10	140	195	2.1	2.1				158.0	140.00	137.00	
C224HE	120	215	40	2.10	2.10	140	195	2.1	2.1				158.0	134.00	129.00	

**Designation examples:**

Barden

FAG

**Sealed design**

124HCRRUL

(B7024C.2RSD.T.P4S.UL)

**Hybrid ceramic design**

C124HCUL

(HCB7024C.T.P4S.UL)

# SPINDLE BEARINGS

## 1800HC/E, 1900HC/E, 100HC/E, 200HC/E, ZSB1900C/E, ZSB100C/E

C: Contact Angle  $\alpha = 15^\circ$  / E: Contact Angle  $\alpha = 25^\circ$

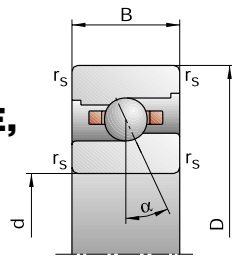

High Speed Design (ZSB)

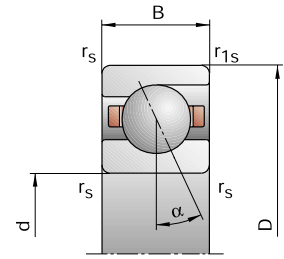

Standard Design

Attainable Speed*		Standard Preload $F_V$ (Force)			Unloading Force $K_{aE}$			Axial Rigidity $S_a$			Sealed Design	Weight	FAG Basic Bearing Number†
Grease	Oil minimal	L	M	H	L	M	H	L	M	H		kg	
min <sup>-1</sup>		N						N/μm					
7500	12000	146	527	1119	445	1734	3956	80.1	141.0	206.3	–	0.5	B71824C.TPA.P4
7000	11000	184	779	1725	530	2323	5308	178.5	305.9	421.9	–	0.5	B71824E.TPA.P4
10000	17000	79	319	700	237	1015	2358	70.8	125.0	179.7	–	0.5	HCB71824C.TPA.P4
8500	14000	80	445	1049	231	1318	3188	151.4	279.6	388.1	–	0.5	HCB71824E.TPA.P4
7000	11000	408	1344	2773	1257	4462	9838	109.5	186.0	267.5	•	1.2	B71924C.T.P4S
6700	10000	591	2087	4388	1726	6291	13620	256.2	411.5	555.9	•	1.2	B71924E.T.P4S
9000	15000	212	742	1566	642	2370	5263	95.1	158.4	222.4	•	1.0	HCB71924C.T.P4S
8000	13000	277	1110	2421	811	3315	7395	222.7	365.9	492.3	•	1.0	HCB71924E.T.P4S
12000	19000	212	742	1566	642	2370	5263	95.1	158.4	222.4	•	1.0	XCB71924C.T.P4S
10000	17000	277	1110	2421	811	3315	7395	222.7	365.9	492.3	•	1.0	XCB71924E.T.P4S
9000	15000	127	382	764	374	1179	2462	77.6	121.2	164.9	•	1.3	HS71924C.T.P4S
8000	13000	207	621	1242	591	1806	3680	196.3	291.4	378.6	•	1.3	HS71924E.T.P4S
11000	18000	88	263	525	260	802	1654	76.7	116.7	155.7	•	1.3	HC71924C.T.P4S
9000	15000	143	428	856	413	1248	2528	196.6	288.6	371.6	•	1.3	HC71924E.T.P4S
14000	22000	88	263	525	260	802	1654	76.7	116.7	155.7	•	1.3	XC71924C.T.P4S
12000	19000	143	428	856	413	1248	2528	196.6	288.6	371.6	•	1.3	XC71924E.T.P4S
6700	10000	657	2107	4308	2035	7046	15410	123.7	208.9	300.3	•	2.1	B7024C.T.P4S
6300	9500	989	3317	6881	2896	10031	21490	291.7	461.2	621.8	•	2.1	B7024E.T.P4S
8500	14000	351	1175	2437	1068	3775	8244	108.3	178.0	248.9	•	1.8	HCB7024C.T.P4S
7500	12000	488	1782	3795	1434	5334	11621	257.6	410.6	548.6	•	1.8	HCB7024E.T.P4S
11000	18000	351	1175	2437	1068	3775	8244	108.3	178.0	248.9	•	1.8	XCB7024C.T.P4S
9500	16000	488	1782	3795	1434	5334	11621	257.6	410.6	548.6	•	1.8	XCB7024E.T.P4S
8500	14000	179	536	1072	530	1659	3480	82.1	128.0	175.0	•	2.3	HS7024C.T.P4S
7500	12000	288	863	1725	824	2511	5114	205.8	305.6	397.2	•	2.3	HS7024E.T.P4S
10000	17000	123	369	737	363	1128	2336	80.5	123.2	164.9	•	2.1	HC7024C.T.P4S
8500	14000	199	598	1196	575	1747	3543	205.8	303.1	390.8	•	2.1	HC7024E.T.P4S
13000	20000	123	369	737	363	1128	2336	80.5	123.2	164.9	•	2.1	XC7024C.T.P4S
11000	18000	199	598	1196	575	1747	3543	205.8	303.1	390.8	•	2.1	XC7024E.T.P4S
6000	9000	1269	3957	8038	3947	13275	28900	140.0	233.9	335.7	–	5.5	B7224C.T.P4S
5300	8000	2003	6418	13107	5898	19505	41076	335.4	522.0	699.7	–	5.5	B7224E.T.P4S
7500	12000	684	2190	4478	2088	7051	15167	122.8	198.5	275.8	–	4.4	HCB7224C.T.P4S
6300	9500	1047	3506	7288	3085	10550	22362	301.6	467.4	618.6	–	4.4	HCB7224E.T.P4S

### X-life ultra design

**XC124HCUL**  
(XCB7024C.T.P4S.UL)

† FAG Basic Bearing Number is for reference only. All bearings are available exclusively from Barden, and must be ordered using the Barden Basic Bearing Number.

\* = speeds indicated are for spring preloads.



# SPINDLE BEARINGS

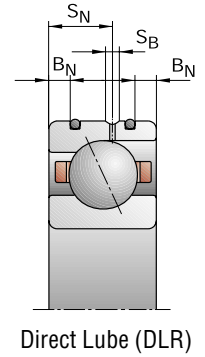
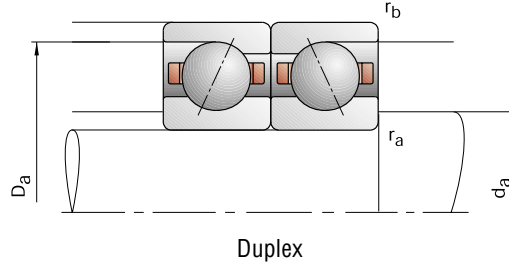
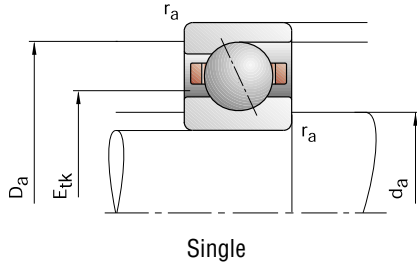

Barden Basic Bearing Number	Dimensions					Shaft & Shoulder Housing Dimensions				DLR Dimensions				Load Ratings			
	d	D	B	r <sub>smin</sub>	r <sub>1smin</sub>	d <sub>a</sub> h12	D <sub>a</sub> H12	r <sub>a</sub> max	r <sub>b</sub> max	B <sub>N</sub>	S <sub>N</sub>	S <sub>B</sub>	E <sub>tk</sub>	C <sub>dyn</sub>	C <sub>0stat</sub>		
	mm															kN	
1826HC	130	165	18	1.10	0.60	137	158	1.1	0.6				143.1	42.50	51.00		
1826HE	130	165	18	1.10	0.60	137	158	1.1	0.6				143.1	40.00	48.00		
C1826HC	130	165	18	1.10	0.60	137	158	1.1	0.6				143.1	29.00	35.50		
C1826HE	130	165	18	1.10	0.60	137	158	1.1	0.6				143.1	27.50	33.50		
1926HC	130	180	24	1.50	1.50	139	171	0.6	0.6				150.2	86.50	100.00		
1926HE	130	180	24	1.50	1.50	139	171	0.6	0.6				150.2	81.50	95.00		
C1926HC	130	180	24	1.50	1.50	139	171	0.6	0.6				150.2	60.00	69.50		
C1926HE	130	180	24	1.50	1.50	139	171	0.6	0.6				150.2	57.00	65.50		
XC1926HC	130	180	24	1.50	1.50	139	171	0.6	0.6				150.2	134.00	69.50		
XC1926HE	130	180	24	1.50	1.50	139	171	0.6	0.6				150.2	127.00	65.50		
ZSB1926C	130	180	24	1.50	1.50	139	171	0.6	0.6				151.0	41.50	56.00		
ZSB1926E	130	180	24	1.50	1.50	139	171	0.6	0.6				151.0	39.00	52.00		
CZSB1926C	130	180	24	1.50	1.50	139	171	0.6	0.6				151.0	29.00	39.00		
CZSB1926E	130	180	24	1.50	1.50	139	171	0.6	0.6				151.0	27.00	36.50		
XCZSB1926C	130	180	24	1.50	1.50	139	171	0.6	0.6				151.0	64.00	39.00		
XCZSB1926E	130	180	24	1.50	1.50	139	171	0.6	0.6				151.0	60.00	36.50		
126HC	130	200	33	2.00	2.00	142	189	2.0	1.0				157.2	143.00	150.00		
126HE	130	200	33	2.00	2.00	142	189	2.0	1.0				157.2	137.00	143.00		
C126HC	130	200	33	2.00	2.00	142	189	2.0	1.0				157.2	100.00	104.00		
C126HE	130	200	33	2.00	2.00	142	189	2.0	1.0				157.2	95.00	98.00		
XC126HC	130	200	33	2.00	2.00	142	189	2.0	1.0				157.2	224.00	104.00		
XC126HE	130	200	33	2.00	2.00	142	189	2.0	1.0				157.2	212.00	98.00		
ZSB126C	130	200	33	2.00	2.00	142	189	2.0	1.0				159.7	65.50	83.00		
ZSB126E	130	200	33	2.00	2.00	142	189	2.0	1.0				159.7	62.00	78.00		
CZSB126C	130	200	33	2.00	2.00	142	189	2.0	1.0				159.7	45.50	58.50		
CZSB126E	130	200	33	2.00	2.00	142	189	2.0	1.0				159.7	42.50	54.00		
XCZSB126C	130	200	33	2.00	2.00	142	189	2.0	1.0				159.7	102.00	58.50		
XCZSB126E	130	200	33	2.00	2.00	142	189	2.0	1.0				159.7	95.00	54.00		
226HC	130	230	40	3.00	3.00	148	211.5	2.5	2.5				170.5	212.00	216.00		
226HE	130	230	40	3.00	3.00	148	211.5	2.5	2.5				170.5	204.00	204.00		
C226HC	130	230	40	3.00	3.00	148	211.5	2.5	2.5				170.5	146.00	150.00		
C226HE	130	230	40	3.00	3.00	148	211.5	2.5	2.5				170.5	140.00	143.00		

### Designation examples:

Barden

FAG

### Sealed design

126HCRRUL

(B7026C.2RSD.T.P4S.UL)

### Hybrid ceramic design

C126HCUL

(HCB7026C.T.P4S.UL)

# SPINDLE BEARINGS

## 1800HC/E, 1900HC/E, 100HC/E, 200HC/E, ZSB1900C/E, ZSB100C/E

C: Contact Angle  $\alpha = 15^\circ$  / E: Contact Angle  $\alpha = 25^\circ$

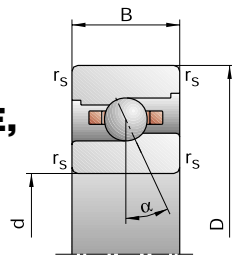

High Speed Design (ZSB)

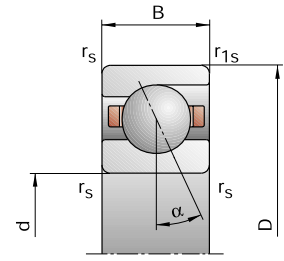

Standard Design

Attainable Speed*	Grease	Oil minimal	Standard Preload $F_V$ (Force)			Unloading Force $K_{aE}$			Axial Rigidity $S_a$			Sealed Design	Weight	FAG Basic Bearing Number†
			L	M	H	L	M	H	L	M	H			
min <sup>-1</sup>			N						N/μm				kg	
7000	11000	208	723	1523	640	2413	5455	93.6	163.8	239.5	–	0.8	B71826C.TPA.P4	
6300	9500	277	1092	2378	805	3288	7397	211.6	354.6	487.6	–	0.8	B71826E.TPA.P4	
9000	15000	119	452	975	360	1456	3330	84.2	146.5	210.2	–	0.8	HCB71826C.TPA.P4	
7500	12000	137	653	1493	399	1952	4574	187.2	328.8	452.6	–	0.8	HCB71826E.TPA.P4	
6700	10000	489	1600	3291	1508	5317	11665	117.5	199.0	285.6	•	1.5	B71926C.T.P4S	
6000	9000	714	2477	5193	2087	7472	16123	275.6	439.7	593.2	•	1.5	B71926E.T.P4S	
8500	14000	258	887	1858	781	2837	6249	102.6	169.8	237.6	•	1.3	HCB71926C.T.P4S	
7000	11000	349	1354	2923	1022	4049	8917	242.7	395.0	529.1	•	1.3	HCB71926E.T.P4S	
11000	18000	258	887	1858	781	2837	6249	102.6	169.8	237.6	•	1.3	XCB71926C.T.P4S	
9500	16000	349	1354	2923	1022	4049	8917	242.7	395.0	529.1	•	1.3	XCB71926E.T.P4S	
8500	14000	145	436	871	427	1345	2804	82.1	128.1	174.1	•	1.8	HS71926C.T.P4S	
7000	11000	238	713	1426	680	2074	4214	208.3	308.9	400.9	•	1.8	HS71926E.T.P4S	
9500	16000	100	300	600	295	914	1889	80.9	123.3	164.6	•	1.7	HC71926C.T.P4S	
8000	13000	163	488	975	470	1423	2879	207.5	305.2	392.7	•	1.7	HC71926E.T.P4S	
12000	19000	100	300	600	295	914	1889	80.9	123.3	164.6	•	1.7	XC71926C.T.P4S	
11000	18000	163	488	975	470	1423	2879	207.5	305.2	392.7	•	1.7	XC71926E.T.P4S	
6000	9000	857	2720	5545	2658	9109	19842	137.9	231.8	332.6	•	3.2	B7026C.T.P4S	
5600	8500	1322	4358	8972	3877	13200	27997	327.9	515.3	692.2	•	3.2	B7026E.T.P4S	
7500	12000	460	1518	3139	1402	4882	10629	120.9	197.6	275.9	•	2.7	HCB7026C.T.P4S	
6700	10000	673	2379	5019	1976	7133	15398	292.4	461.5	614.7	•	2.7	HCB7026E.T.P4S	
10000	17000	460	1518	3139	1402	4882	10629	120.9	197.6	275.9	•	2.7	XCB7026C.T.P4S	
8500	14000	673	2379	5019	1976	7133	15398	292.4	461.5	614.7	•	2.7	XCB7026E.T.P4S	
7500	12000	228	683	1367	675	2113	4422	92.9	144.9	197.6	•	3.7	HS7026C.T.P4S	
6700	10000	368	1104	2208	1053	3212	6547	233.4	346.6	450.6	•	3.7	HS7026E.T.P4S	
9000	15000	159	476	951	470	1455	3007	91.8	140.1	187.3	•	3.5	HC7026C.T.P4S	
7500	12000	257	771	1541	741	2254	4567	234.1	345.0	444.5	•	3.5	HC7026E.T.P4S	
12000	19000	159	476	951	470	1455	3007	91.8	140.1	187.3	•	3.5	XC7026C.T.P4S	
10000	17000	257	771	1541	741	2254	4567	234.1	345.0	444.5	•	3.5	XC7026E.T.P4S	
5600	8500	1316	4108	8347	4084	13741	29821	147.9	246.8	353.2	–	6.3	B7226C.T.P4S	
5000	7500	2079	6671	13628	6116	20247	42633	355.2	552.6	740.1	–	6.3	B7226E.T.P4S	
7000	11000	719	2304	4709	2193	7407	15918	130.6	210.9	292.8	–	5.2	HCB7226C.T.P4S	
6000	9000	1079	3624	7521	3177	10892	23040	318.7	494.0	652.9	–	5.2	HCB7226E.T.P4S	

### X-life ultra design

**XC126HCUL**  
(XCB7026C.T.P4S.UL)

† FAG Basic Bearing Number is for reference only. All bearings are available exclusively from Barden, and must be ordered using the Barden Basic Bearing Number.

\* = speeds indicated are for spring preloads.





# SPINDLE BEARINGS

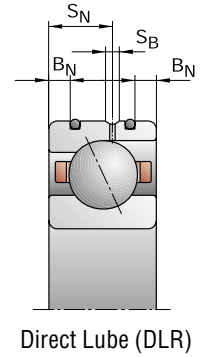
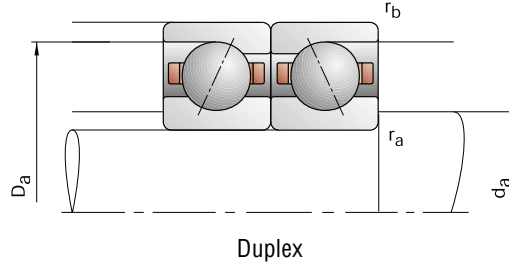
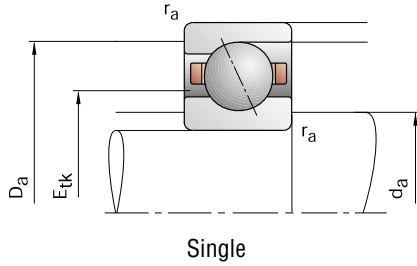

Barden Basic Bearing Number	Dimensions					Shaft & Shoulder Housing Dimensions				DLR Dimensions				Load Ratings			
	d	D	B	r <sub>smin</sub>	r <sub>1smin</sub>	d <sub>a</sub> h12	D <sub>a</sub> H12	r <sub>a</sub> max	r <sub>b</sub> max	B <sub>N</sub>	S <sub>N</sub>	S <sub>B</sub>	E <sub>tk</sub>	C <sub>dyn</sub>	C <sub>0stat</sub>		
	mm															kN	
1828HC	140	175	18	1.10	0.60	147	168	1.1	0.6				153.1	43.00	54.00		
1828HE	140	175	18	1.10	0.60	147	168	1.1	0.6				153.1	40.50	51.00		
C1828HC	140	175	18	1.10	0.60	147	168	1.1	0.6				153.1	30.00	38.00		
C1828HE	140	175	18	1.10	0.60	147	168	1.1	0.6				153.1	28.00	35.50		
1928HC	140	190	24	1.50	1.50	149	181	0.6	0.6				160.2	90.00	108.00		
1928HE	140	190	24	1.50	1.50	149	181	0.6	0.6				160.2	85.00	102.00		
C1928HC	140	190	24	1.50	1.50	149	181	0.6	0.6				160.2	62.00	76.50		
C1928HE	140	190	24	1.50	1.50	149	181	0.6	0.6				160.2	58.50	71.00		
XC1928HC	140	190	24	1.50	1.50	149	181	0.6	0.6				160.2	137.00	76.50		
XC1928HE	140	190	24	1.50	1.50	149	181	0.6	0.6				160.2	129.00	71.00		
128HC	140	210	33	2.00	2.00	152	199	2.0	1.0				167.2	146.00	160.00		
128HE	140	210	33	2.00	2.00	152	199	2.0	1.0				167.2	140.00	150.00		
C128HC	140	210	33	2.00	2.00	152	199	2.0	1.0				167.2	102.00	110.00		
C128HE	140	210	33	2.00	2.00	152	199	2.0	1.0				167.2	96.50	104.00		
XC128HC	140	210	33	2.00	2.00	152	199	2.0	1.0				167.2	228.00	110.00		
XC128HE	140	210	33	2.00	2.00	152	199	2.0	1.0				167.2	216.00	104.00		
228HC	140	250	42	3.00	3.00	163	226.5	2.5	2.5				185.5	220.00	232.00		
228HE	140	250	42	3.00	3.00	163	226.5	2.5	2.5				185.5	212.00	224.00		
C228HC	140	250	42	3.00	3.00	163	226.5	2.5	2.5				185.5	153.00	163.00		
C228HE	140	250	42	3.00	3.00	163	226.5	2.5	2.5				185.5	146.00	156.00		

### Designation examples:

Barden  
FAG

### Sealed design

128HCRRUL  
(B7028C.2RSD.T.P4S.UL)

### Hybrid ceramic design

C128HCUL  
(HC B7028C.T.P4S.UL)

# SPINDLE BEARINGS

## 1800HC/E, 1900HC/E, 100HC/E, 200HC/E

C: Contact Angle  $\alpha = 15^\circ$  / E: Contact Angle  $\alpha = 25^\circ$

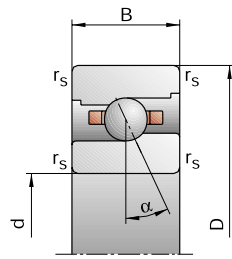

High Speed Design (ZSB)

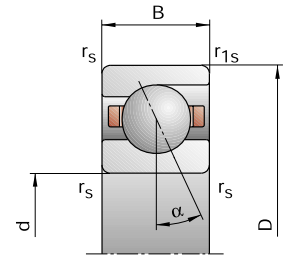

Standard Design

Attainable Speed*		Standard Preload $F_V$ (Force)			Unloading Force $K_{aE}$			Axial Rigidity $S_a$			Sealed Design	Weight	FAG Basic Bearing Number†		
Grease	Oil minimal	L	M	H	L	M	H	L	M	H		kg			
min <sup>-1</sup>		N											N/μm	kg	
6300	9500	208	728	1536	638	2418	5469	97.1	169.7	247.6	–	0.8	B71828C.TPA.P4		
6000	9000	275	1097	2397	798	3296	7435	219.6	369.0	507.2	–	0.8	B71828E.TPA.P4		
8000	13000	121	466	1007	366	1498	3430	88.1	153.7	220.4	–	0.8	HCB71828C.TPA.P4		
7000	11000	135	659	1511	393	1968	4620	194.0	343.2	472.1	–	0.8	HCB71828E.TPA.P4		
6000	9000	506	1661	3412	1557	5502	12044	124.7	210.9	301.9	•	1.6	B71928C.T.P4S		
5600	8500	740	2576	5405	2162	7760	16750	293.3	467.9	630.8	•	1.6	B71928E.T.P4S		
7500	12000	266	919	1928	804	2932	6464	108.9	180.1	251.8	•	1.4	HCB71928C.T.P4S		
6700	10000	354	1387	3002	1036	4142	9141	256.5	418.2	560.2	•	1.4	HCB71928E.T.P4S		
10000	17000	266	919	1928	804	2932	6464	108.9	180.1	251.8	•	1.4	XCB71928C.T.P4S		
8500	14000	354	1387	3002	1036	4142	9141	256.5	418.2	560.2	•	1.4	XCB71928E.T.P4S		
5600	8500	873	2775	5657	2703	9270	20180	142.9	240.1	343.9	•	3.4	B7028C.T.P4S		
5000	7500	1345	4446	9159	3941	13450	28537	340.3	534.9	718.2	•	3.4	B7028E.T.P4S		
7000	11000	480	1583	3273	1463	5089	11075	126.7	206.9	288.7	•	2.8	HCB7028C.T.P4S		
6300	9500	687	2434	5127	2016	7292	15712	304.0	479.8	638.4	•	2.8	HCB7028E.T.P4S		
9500	16000	480	1583	3273	1463	5089	11075	126.7	206.9	288.7	•	2.8	XCB7028C.T.P4S		
8000	13000	687	2434	5127	2016	7292	15712	304.0	479.8	638.4	•	2.8	XCB7028E.T.P4S		
5000	7500	1363	4259	8634	4222	14208	30737	155.8	259.6	370.7	–	8.1	B7228C.T.P4S		
4500	6700	2154	6923	14150	6331	20931	44194	374.8	582.4	780.4	–	8.1	B7228E.T.P4S		
6300	9500	747	2397	4901	2276	7692	16528	137.9	222.5	308.6	–	6.8	HCB7228C.T.P4S		
5300	8000	1133	3811	7910	3335	11447	24211	338.1	524.1	692.5	–	6.8	HCB7228E.T.P4S		

### X-life ultra design

**XC128HCUL**  
(**XCB7028C.T.P4S.UL**)

† FAG Basic Bearing Number is for reference only. All bearings are available exclusively from Barden, and must be ordered using the Barden Basic Bearing Number.

\* = speeds indicated are for spring preloads.



# SPINDLE BEARINGS

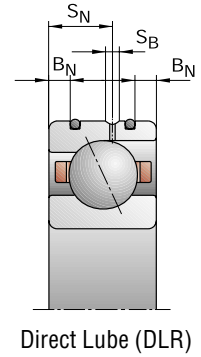
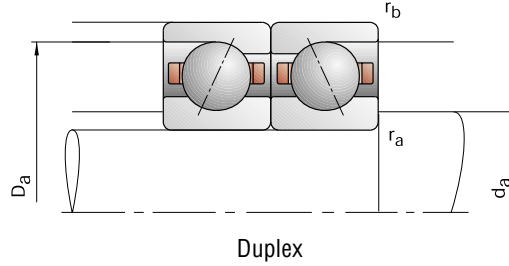
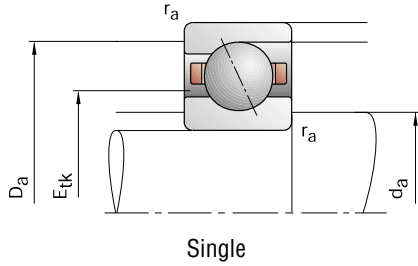

Barden Basic Bearing Number	Dimensions					Shaft & Shoulder Housing Dimensions				DLR Dimensions				Load Ratings			
	d	D	B	r <sub>smin</sub>	r <sub>1smin</sub>	d <sub>a</sub> h12	D <sub>a</sub> H12	r <sub>a</sub> max	r <sub>b</sub> max	B <sub>N</sub>	S <sub>N</sub>	S <sub>B</sub>	E <sub>tk</sub>	C <sub>dyn</sub>	C <sub>0stat</sub>		
	mm															kN	
1830HC	150	190	20	1.10	0.60	158	182	1.1	0.6				164.8	56.00	69.50		
1830HE	150	190	20	1.10	0.60	158	182	1.1	0.6				164.8	52.00	64.00		
C1830HC	150	190	20	1.10	0.60	158	182	1.1	0.6				164.8	38.00	48.00		
C1830HE	150	190	20	1.10	0.60	158	182	1.1	0.6				164.8	36.00	45.00		
1930HC	150	210	28	2.00	1.00	160	199	1.0	1.0				174.3	122.00	143.00		
1930HE	150	210	28	2.00	1.00	160	199	1.0	1.0				174.3	114.00	134.00		
C1930HC	150	210	28	2.00	1.00	160	199	1.0	1.0				174.3	85.00	100.00		
C1930HE	150	210	28	2.00	1.00	160	199	1.0	1.0				174.3	80.00	95.00		
XC1930HC	150	210	28	2.00	1.00	160	199	1.0	1.0				174.3	190.00	100.00		
XC1930HE	150	210	28	2.00	1.00	160	199	1.0	1.0				174.3	180.00	95.00		
130HC	150	225	35	2.10	2.10	163	213	2.1	1.0				178.5	183.00	193.00		
130HE	150	225	35	2.10	2.10	163	213	2.1	1.0				178.5	173.00	186.00		
C130HC	150	225	35	2.10	2.10	163	213	2.1	1.0				178.5	127.00	137.00		
C130HE	150	225	35	2.10	2.10	163	213	2.1	1.0				178.5	120.00	129.00		
XC130HC	150	225	35	2.10	2.10	163	213	2.1	1.0				178.5	285.00	137.00		
XC130HE	150	225	35	2.10	2.10	163	213	2.1	1.0				178.5	270.00	129.00		
230HC	150	270	45	3.00	3.00	178	241.5	2.5	2.5				200.5	228.00	255.00		
230HE	150	270	45	3.00	3.00	178	241.5	2.5	2.5				200.5	216.00	240.00		
C230HC	150	270	45	3.00	3.00	178	241.5	2.5	2.5				200.5	156.00	176.00		
C230HE	150	270	45	3.00	3.00	178	241.5	2.5	2.5				200.5	150.00	166.00		

### Designation examples:

Barden  
FAG

### Hybrid ceramic design

C130HCUL  
(HCB7030C.T.P4S.UL)

### X-life ultra design

XC130HCUL  
(XCB7030C.T.P4S.UL)

# SPINDLE BEARINGS

## 1800HC/E, 1900HC/E, 100HC/E, 200HC/E

C: Contact Angle  $\alpha = 15^\circ$  / E: Contact Angle  $\alpha = 25^\circ$

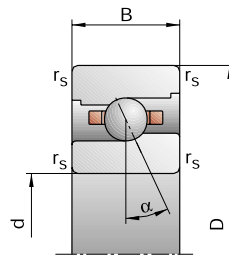

High Speed Design (ZSB)

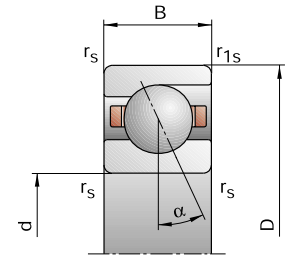

Standard Design

Attainable Speed*		Standard Preload $F_V$ (Force)			Unloading Force $K_{aE}$			Axial Rigidity $S_a$			Sealed Design	Weight	FAG Basic Bearing Number†
Grease	Oil minimal	L	M	H	L	M	H	L	M	H		kg	
min <sup>-1</sup>		N						N/μm					
6000	9000	281	955	1995	866	3180	7140	108.7	188.1	274.0	–	1.1	B71830C.TPA.P4
5300	8000	386	1465	3145	1124	4405	9789	248.3	410.2	561.3	–	1.1	B71830E.TPA.P4
7500	12000	170	624	1332	516	2015	4559	100.1	172.0	245.8	–	1.1	HCB71830C.TPA.P4
6300	9500	202	891	1994	588	2660	6112	224.3	383.5	523.9	–	1.1	HCB71830E.TPA.P4
5600	8500	710	2286	4680	2188	7583	16579	141.4	237.8	340.6	–	2.5	B71930C.T.P4S
5000	7500	1046	3541	7369	3055	10662	22894	332.6	525.8	707.9	–	2.5	B71930E.T.P4S
7000	11000	375	1261	2622	1137	4024	8792	123.6	202.5	282.3	–	2.1	HCB71930C.T.P4S
6000	9000	519	1925	4116	1523	5747	12558	294.8	471.4	629.5	–	2.1	HCB71930E.T.P4S
9000	15000	375	1261	2622	1137	4024	8792	123.6	202.5	282.3	–	2.1	XCB71930C.T.P4S
8000	13000	519	1925	4116	1523	5747	12558	294.8	471.4	629.5	–	2.1	XCB71930E.T.P4S
5300	8000	1111	3503	7142	3449	11700	25557	157.2	263.0	377.6	–	4.1	B7030C.T.P4S
4800	7000	1705	5555	11417	5003	16818	35626	373.2	583.4	782.8	–	4.1	B7030E.T.P4S
6700	10000	601	1960	4031	1829	6289	13611	138.1	224.5	312.6	–	3.3	HCB7030C.T.P4S
5600	8500	898	3106	6501	2639	9320	19942	336.8	527.5	700.2	–	3.3	HCB7030E.T.P4S
8500	14000	601	1960	4031	1829	6289	13611	138.1	224.5	312.6	–	3.3	XCB7030C.T.P4S
7500	12000	898	3106	6501	2639	9320	19942	336.8	527.5	700.2	–	3.3	XCB7030E.T.P4S
4500	6700	1411	4410	8942	4364	14677	31741	163.8	272.4	388.5	–	10.3	B7230C.T.P4S
4000	6000	2186	7023	14400	6418	21195	44874	391.6	607.6	814.2	–	10.3	B7230E.T.P4S
5600	8500	768	2470	5053	2336	7909	16996	144.6	233.3	323.2	–	9.0	HCB7230C.T.P4S
5000	7500	1144	3861	8025	3364	11580	24520	352.8	547.0	722.5	–	9.0	HCB7230E.T.P4S

† FAG Basic Bearing Number is for reference only. All bearings are available exclusively from Barden, and must be ordered using the Barden Basic Bearing Number.

\* = speeds indicated are for spring preloads.



# SPINDLE BEARINGS

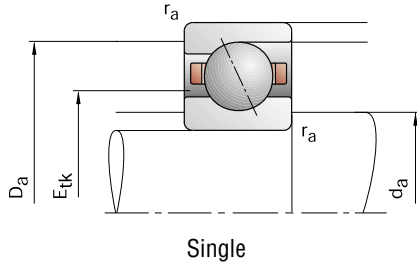

Single

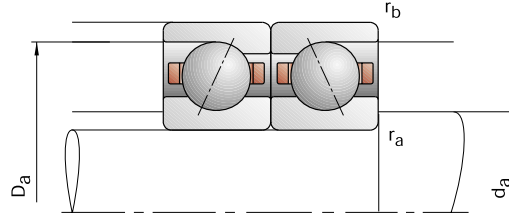

Duplex

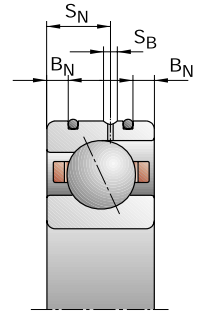

Direct Lube (DLR)

Barden Basic Bearing Number	Dimensions					Shaft & Shoulder Housing Dimensions				DLR Dimensions				Load Ratings			
	d	D	B	r <sub>smin</sub>	r <sub>1smin</sub>	d <sub>a</sub> h12	D <sub>a</sub> H12	r <sub>a</sub> max	r <sub>b</sub> max	B <sub>N</sub>	S <sub>N</sub>	S <sub>B</sub>	E <sub>tk</sub>	C <sub>dyn</sub>	C <sub>0stat</sub>		
	mm															kN	
1832HC	160	200	20	1.10	0.60	168	192	1.1	0.6				174.8	57.00	73.50		
1832HE	160	200	20	1.10	0.60	168	192	1.1	0.6				174.8	54.00	68.00		
C1832HC	160	200	20	1.10	0.60	168	192	1.1	0.6				174.8	39.00	51.00		
C1832HE	160	200	20	1.10	0.60	168	192	1.1	0.6				174.8	37.50	48.00		
1932HC	160	220	28	2.00	1.00	170	209	1.0	1.0				184.3	125.00	150.00		
1932HE	160	220	28	2.00	1.00	170	209	1.0	1.0				184.3	116.00	140.00		
C1932HC	160	220	28	2.00	1.00	170	209	1.0	1.0				184.3	85.00	104.00		
C1932HE	160	220	28	2.00	1.00	170	209	1.0	1.0				184.3	80.00	98.00		
XC1932HC	160	220	28	2.00	1.00	170	209	1.0	1.0				184.3	190.00	104.00		
XC1932HE	160	220	28	2.00	1.00	170	209	1.0	1.0				184.3	180.00	98.00		
132HC	160	240	38	2.10	2.10	174	228	2.0	1.0				191.0	190.00	208.00		
132HE	160	240	38	2.10	2.10	174	228	2.0	1.0				191.0	176.00	196.00		
C132HC	160	240	38	2.10	2.10	174	228	2.0	1.0				191.0	129.00	143.00		
C132HE	160	240	38	2.10	2.10	174	228	2.0	1.0				191.0	122.00	137.00		
XC132HC	160	240	38	2.10	2.10	174	228	2.0	1.0				191.0	290.00	143.00		
XC132HE	160	240	38	2.10	2.10	174	228	2.0	1.0				191.0	270.00	137.00		
232HC	160	290	48	3.00	3.00	191	259	2.5	2.5				215.5	245.00	285.00		
232HE	160	290	48	3.00	3.00	191	259	2.5	2.5				215.5	232.00	270.00		
C232HC	160	290	48	3.00	3.00	191	259	2.5	2.5				215.5	170.00	200.00		
C232HE	160	290	48	3.00	3.00	191	259	2.5	2.5				215.5	160.00	190.00		
1834HC	170	215	22	1.10	0.60	179	206	1.1	0.6				186.7	68.00	88.00		
1834HE	170	215	22	1.10	0.60	179	206	1.1	0.6				186.7	64.00	81.50		
C1834HC	170	215	22	1.10	0.60	179	206	1.1	0.6				186.7	47.50	61.00		
C1834HE	170	215	22	1.10	0.60	179	206	1.1	0.6				186.7	45.00	57.00		
1934HC	170	230	28	2.00	1.50	180	219	1.0	1.0				194.3	129.00	163.00		
1934HE	170	230	28	2.00	1.50	180	219	1.0	1.0				194.3	122.00	150.00		
C1934HC	170	230	28	2.00	1.50	180	219	1.0	1.0				194.3	88.00	114.00		
C1934HE	170	230	28	2.00	1.50	180	219	1.0	1.0				194.3	83.00	106.00		
134HC	170	260	42	2.10	2.10	185	246	2.0	1.0				203.8	236.00	270.00		
134HE	170	260	42	2.10	2.10	185	246	2.0	1.0				203.8	224.00	255.00		
234HC	170	310	52	4.00	4.00	205	275	3.0	3.0				228.6	300.00	360.00		
234HE	170	310	52	4.00	4.00	205	275	3.0	3.0				228.6	280.00	345.00		

**Designation examples:**

Barden

FAG

**Hybrid ceramic design**

C132HCUL

(HCB7032C.T.P4S.UL)

**X-life ultra design**

XC132HCUL

(XCB7032C.T.P4S.UL)

# SPINDLE BEARINGS

## 1800HC/E, 1900HC/E, 100HC/E, 200HC/E

C: Contact Angle  $\alpha = 15^\circ$  / E: Contact Angle  $\alpha = 25^\circ$

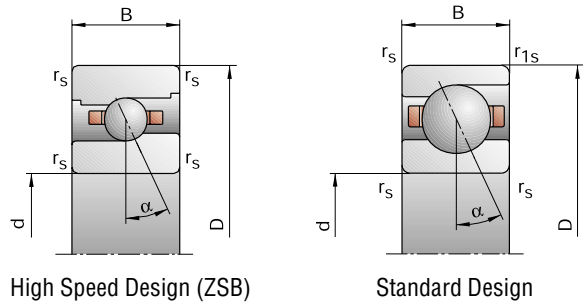

High Speed Design (ZSB)

Standard Design

Attainable Speed*		Standard Preload $F_V$ (Force)			Unloading Force $K_{aE}$			Axial Rigidity $S_a$			Sealed Design	Weight	FAG Basic Bearing Number†
Grease	Oil minimal	L	M	H	L	M	H	L	M	H		kg	
min <sup>-1</sup>		N						N/ $\mu$ m					
5600	8500	283	969	2032	869	3214	7238	113.0	195.6	284.9	–	1.2	B71832C.TPA.P4
5000	7500	389	1485	3194	1132	4457	9917	259.3	428.3	585.7	–	1.2	B71832E.TPA.P4
7000	11000	171	629	1349	518	2024	4596	104.2	178.7	255.3	–	1.2	HCB71832C.TPA.P4
6000	9000	203	911	2043	591	2717	6253	234.1	402.1	549.2	–	1.2	HCB71832E.TPA.P4
5000	7500	727	2341	4793	2238	7755	16952	146.1	245.5	351.4	–	2.7	B71932C.T.P4S
4800	7000	1061	3597	7491	3097	10821	23248	342.8	541.8	729.2	–	2.7	B71932E.T.P4S
6700	10000	382	1286	2676	1157	4099	8959	127.5	208.8	290.9	–	2.2	HCB71932C.T.P4S
5600	8500	529	1965	4204	1552	5864	12818	304.5	487.0	650.1	–	2.2	HCB71932E.T.P4S
8500	14000	382	1286	2676	1157	4099	8959	127.5	208.8	290.9	–	2.2	XCB71932C.T.P4S
7500	12000	529	1965	4204	1552	5864	12818	304.5	487.0	650.1	–	2.2	XCB71932E.T.P4S
4800	7000	1152	3635	7412	3573	12127	26413	164.1	274.5	393.4	–	5.1	B7032C.T.P4S
4300	6300	1728	5642	11602	5066	17061	36142	386.8	604.6	810.7	–	5.1	B7032E.T.P4S
6000	9000	624	2034	4184	1898	6521	14111	144.4	234.6	326.4	–	4.3	HCB7032C.T.P4S
5300	8000	911	3160	6621	2676	9473	20288	349.4	547.3	726.5	–	4.3	HCB7032E.T.P4S
8000	13000	624	2034	4184	1898	6521	14111	144.4	234.6	326.4	–	4.3	XCB7032C.T.P4S
6700	10000	911	3160	6621	2676	9473	20288	349.4	547.3	726.5	–	4.3	XCB7032E.T.P4S
4300	6300	1513	4734	9601	4669	15702	33935	179.9	298.6	425.1	–	13.0	B7232C.T.P4S
3800	5600	2339	7529	15450	6844	22687	48049	430.4	668.0	894.5	–	13.0	B7232E.T.P4S
5300	8000	832	2676	5478	2528	8552	18377	159.6	257.2	356.0	–	11.6	HCB7232C.T.P4S
4500	6700	1231	4167	8669	3618	12488	26454	389.0	603.5	796.8	–	11.6	HCB7232E.T.P4S
5000	7500	357	1199	2492	1097	3988	8875	122.5	210.9	305.7	–	1.6	B71834C.TPA.P4
4500	6700	499	1842	3924	1451	5538	12172	282.1	461.1	627.9	–	1.6	B71834E.TPA.P4
6300	9500	216	772	1638	654	2485	5597	112.6	191.4	272.7	–	1.6	HCB71834C.TPA.P4
5600	8500	274	1148	2539	799	3431	7770	258.7	434.4	590.4	–	1.6	HCB71834E.TPA.P4
4800	7000	747	2410	4941	2295	7954	17399	154.3	258.7	369.9	–	2.8	B71934C.T.P4S
4500	6700	1111	3777	7870	3242	11353	24396	365.5	577.8	777.2	–	2.8	B71934E.T.P4S
6000	9000	392	1328	2765	1186	4222	9226	134.9	220.8	307.2	–	2.4	HCB71934C.T.P4S
5300	8000	542	2028	4349	1589	6046	13242	322.2	516.2	689.2	–	2.4	HCB71934E.T.P4S
4500	6700	1458	4562	9252	4504	15154	32763	171.7	285.2	406.4	–	6.7	B7034C.T.P4S
4000	6000	2263	7276	14926	6641	21942	46466	411.2	637.9	854.5	–	6.7	B7034E.T.P4S
4000	6000	1878	5842	11825	5792	19336	41658	190.3	314.3	446.1	–	16.0	B7234C.T.P4S
3600	5300	2879	9183	18737	8424	27661	58033	454.6	702.4	936.0	–	16.0	B7234E.T.P4S

† FAG Basic Bearing Number is for reference only. All bearings are available exclusively from Barden, and must be ordered using the Barden Basic Bearing Number.

\* = speeds indicated are for spring preloads.



# SPINDLE BEARINGS

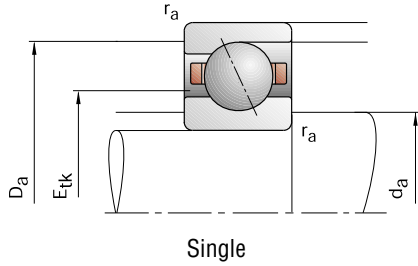

Single

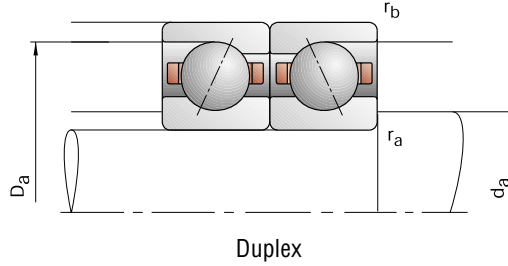

Duplex

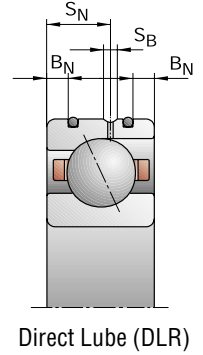

Direct Lube (DLR)

Barden Basic Bearing Number	Dimensions					Shaft & Shoulder Housing Dimensions				DLR Dimensions				Load Ratings			
	d	D	B	r <sub>smin</sub>	r <sub>1smin</sub>	d <sub>a</sub> h12	D <sub>a</sub> H12	r <sub>a</sub> max	r <sub>b</sub> max	B <sub>N</sub>	S <sub>N</sub>	S <sub>B</sub>	E <sub>tk</sub>	C <sub>dyn</sub>	C <sub>0stat</sub>		
	mm															kN	
1836HC	180	225	22	1.10	0.60	189	216	1.1	0.6				196.7	71.00	93.00		
1836HE	180	225	22	1.10	0.60	189	216	1.1	0.6				196.7	67.00	86.50		
C1836HC	180	225	22	1.10	0.60	189	216	1.1	0.6				196.7	49.00	65.50		
C1836HE	180	225	22	1.10	0.60	189	216	1.1	0.6				196.7	45.50	60.00		
1936HC	180	250	33	2.00	1.00	192	238	1.0	1.0				208.3	163.00	204.00		
1936HE	180	250	33	2.00	1.00	192	238	1.0	1.0				208.3	156.00	193.00		
C1936HC	180	250	33	2.00	1.00	192	238	1.0	1.0				208.3	114.00	143.00		
C1936HE	180	250	33	2.00	1.00	192	238	1.0	1.0				208.3	106.00	134.00		
136HC	180	280	46	2.10	2.10	196	264	2.0	1.0				218.8	245.00	285.00		
136HE	180	280	46	2.10	2.10	196	264	2.0	1.0				218.8	232.00	275.00		
236HC	180	320	52	4.00	4.00	213.5	286.5	3.0	3.0				238.6	305.00	390.00		
236HE	180	320	52	4.00	4.00	213.5	286.5	3.0	3.0				238.6	290.00	365.00		
1838HC	190	240	24	1.50	0.60	201	229	1.5	0.6				208.9	80.00	108.00		
1838HE	190	240	24	1.50	0.60	201	229	1.5	0.6				208.9	75.00	100.00		
C1838HC	190	240	24	1.50	0.60	201	229	1.5	0.6				208.9	55.00	75.00		
C1838HE	190	240	24	1.50	0.60	201	229	1.5	0.6				208.9	52.00	69.50		
1938HC	190	260	33	2.00	1.00	202	247	1.0	1.0				218.3	166.00	212.00		
1938HE	190	260	33	2.00	1.00	202	247	1.0	1.0				218.3	156.00	200.00		
C1938HC	190	260	33	2.00	1.00	202	247	1.0	1.0				218.3	116.00	150.00		
C1938HE	190	260	33	2.00	1.00	202	247	1.0	1.0				218.3	108.00	140.00		
138HC	190	290	46	2.10	2.10	206	274	2.0	1.0				228.8	250.00	305.00		
138HE	190	290	46	2.10	2.10	206	274	2.0	1.0				228.8	236.00	290.00		
238HC	190	340	55	4.00	4.00	223.5	306.5	3.0	3.0				253.6	315.00	415.00		
238HE	190	340	55	4.00	4.00	223.5	306.5	3.0	3.0				253.6	300.00	390.00		

**Designation examples:**

Barden  
FAG

**Hybrid ceramic design**

C1936HCUL  
(HCB71936C.T.P4S.UL)



# SPINDLE BEARINGS

## 1800HC/E, 1900HC/E, 100HC/E, 200HC/E

C: Contact Angle  $\alpha = 15^\circ$  / E: Contact Angle  $\alpha = 25^\circ$

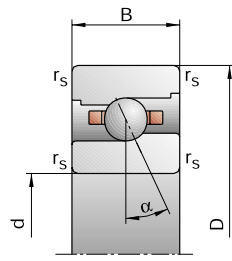

High Speed Design (ZSB)

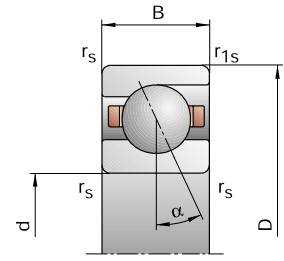

Standard Design



180  
-  
190

Attainable Speed*		Standard Preload $F_V$ (Force)			Unloading Force $K_{aE}$			Axial Rigidity $S_a$			Sealed Design	Weight	FAG Basic Bearing Number†
Grease	Oil minimal	L	M	H	L	M	H	L	M	H		kg	
min <sup>-1</sup>		N						N/μm					
4800	7000	372	1250	2600	1142	4151	9241	129.2	222.3	322.0	–	1.7	B71836C.TPA.P4
4300	6300	520	1919	4103	1511	5766	12717	297.8	486.8	663.3	–	1.7	B71836E.TPA.P4
6000	9000	219	786	1669	662	2530	5681	117.6	200.0	284.1	–	1.7	HCB71836C.TPA.P4
5300	8000	274	1166	2586	799	3481	7901	269.6	454.4	617.5	–	1.7	HCB71836E.TPA.P4
4500	6700	966	3086	6300	2974	10221	22230	168.9	282.3	402.7	–	4.2	B71936C.T.P4S
4000	6000	1478	4921	10164	4320	14823	31493	403.5	633.6	849.1	–	4.2	B71936E.T.P4S
5600	8500	516	1708	3546	1565	5442	11841	148.5	241.1	335.1	–	3.5	HCB71936C.T.P4S
4800	7000	734	2644	5595	2150	7894	17065	357.4	565.8	752.2	–	3.5	HCB71936E.T.P4S
4000	6000	1513	4733	9600	4669	15697	33928	179.9	298.6	425.1	–	8.9	B7036C.T.P4S
3800	5600	2339	7529	15449	6843	22685	48042	430.4	668.0	894.5	–	8.9	B7036E.T.P4S
3800	5600	1906	5935	12015	5866	19581	42153	198.0	326.4	462.3	–	16.8	B7236C.T.P4S
3400	5000	2977	9503	19395	8706	28601	60002	477.2	737.1	981.7	–	16.8	B7236E.T.P4S
4500	6700	353	1299	2772	1074	4276	9771	130.0	230.5	336.7	–	2.2	B71838C.TPA.P4
4000	6000	429	1898	4254	1243	5671	13114	288.3	499.6	691.5	–	2.2	B71838E.TPA.P4
5600	8500	190	797	1764	571	2544	5959	115.1	205.9	296.8	–	2.2	HCB71838C.TPA.P4
4800	7000	181	1095	2626	526	3252	7985	242.2	458.8	640.0	–	2.2	HCB71838E.TPA.P4
4300	6300	894	2996	6210	2736	9846	21803	167.2	283.7	407.1	–	4.4	B71938C.T.P4S
3800	5600	1259	4576	9707	3666	13727	29966	390.1	630.2	851.6	–	4.4	B71938E.T.P4S
5300	8000	449	1619	3440	1353	5130	11428	144.0	240.8	337.0	–	3.6	HCB71938C.T.P4S
4500	6700	564	2402	5321	1650	7148	16175	334.3	559.2	754.7	–	3.6	HCB71938E.T.P4S
3800	5600	1445	4671	9575	4437	15414	33658	181.9	304.8	435.1	–	9.3	B7038C.T.P4S
3600	5300	2141	7290	15228	6260	21908	47088	430.9	680.6	915.2	–	9.3	B7038E.T.P4S
3400	5000	1860	5955	12166	5701	19571	42506	202.3	336.4	477.6	–	20.3	B7238C.T.P4S
3200	4800	2816	9424	19525	8217	28309	60271	484.1	759.4	1016.1	–	20.3	B7238E.T.P4S

† FAG Basic Bearing Number is for reference only. All bearings are available exclusively from Barden, and must be ordered using the Barden Basic Bearing Number.

\* = speeds indicated are for spring preloads.

# SPINDLE BEARINGS

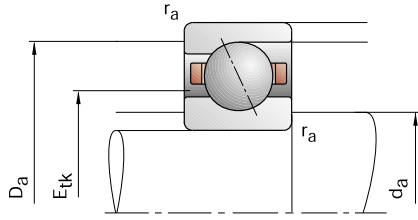

Single

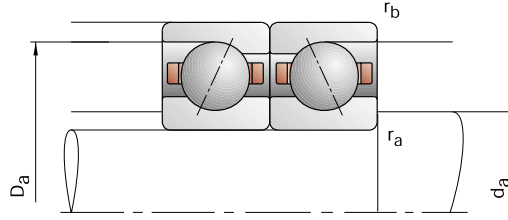

Duplex

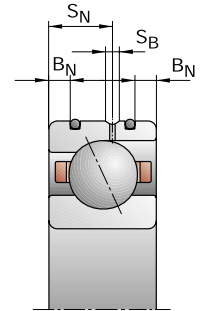

Direct Lube (DLR)

Barden Basic Bearing Number	Dimensions					Shaft & Shoulder Housing Dimensions				DLR Dimensions				Load Ratings			
	d	D	B	r <sub>smin</sub>	r <sub>1smin</sub>	d <sub>a</sub> h12	D <sub>a</sub> H12	r <sub>a</sub> max	r <sub>b</sub> max	B <sub>N</sub>	S <sub>N</sub>	S <sub>B</sub>	E <sub>tk</sub>	C <sub>dyn</sub>	C <sub>0stat</sub>		
	mm															kN	
1840HC	200	250	24	1.50	0.60	211	239	1.5	0.6				218.9	81.50	114.00		
1840HE	200	250	24	1.50	0.60	211	239	1.5	0.6				218.9	76.50	106.00		
C1840HC	200	250	24	1.50	0.60	211	239	1.5	0.6				218.9	57.00	78.00		
C1840HE	200	250	24	1.50	0.60	211	239	1.5	0.6				218.9	53.00	73.50		
1940HC	200	280	38	2.10	1.10	214	266	1.0	1.0				232.4	204.00	255.00		
1940HE	200	280	38	2.10	1.10	214	266	1.0	1.0				232.4	193.00	240.00		
C1940HC	200	280	38	2.10	1.10	214	266	1.0	1.0				232.4	140.00	176.00		
C1940HE	200	280	38	2.10	1.10	214	266	1.0	1.0				232.4	134.00	166.00		
140HC	200	310	51	2.10	2.10	217	293	2.0	1.0				241.5	305.00	390.00		
140HE	200	310	51	2.10	2.10	217	293	2.0	1.0				241.5	290.00	365.00		
240HC	200	360	58	4.00	4.00	238.5	321.5	3.0	3.0				268.6	325.00	440.00		
240HE	200	360	58	4.00	4.00	238.5	321.5	3.0	3.0				268.6	310.00	415.00		
1844HC	220	270	24	1.50	0.60	231	259	1.5	0.6				238.9	83.00	118.00		
1844HE	220	270	24	1.50	0.60	231	259	1.5	0.6				238.9	78.00	110.00		
C1844HC	220	270	24	1.50	0.60	231	259	1.5	0.6				238.9	57.00	83.00		
C1844HE	220	270	24	1.50	0.60	231	259	1.5	0.6				238.9	54.00	76.50		
1944HC	220	300	38	2.10	1.10	234	286	1.0	1.0				252.4	216.00	285.00		
1944HE	220	300	38	2.10	1.10	234	286	1.0	1.0				252.4	204.00	270.00		
C1944HC	220	300	38	2.10	1.10	234	286	1.0	1.0				252.4	150.00	200.00		
C1944HE	220	300	38	2.10	1.10	234	286	1.0	1.0				252.4	140.00	190.00		
144HC	220	340	56	3.00	3.00	239	321	2.5	1.0				266.5	325.00	440.00		
144HE	220	340	56	3.00	3.00	239	321	2.5	1.0				266.5	310.00	415.00		
244HC	220	400	65	4.00	4.00	264	356	3.0	3.0				296.2	400.00	560.00		
244HE	220	400	65	4.00	4.00	264	356	3.0	3.0				296.2	380.00	540.00		

**Designation examples:**

Barden

FAG

**Hybrid ceramic design**

C1940HCUL

(HCB71940C.T.P4S.UL)

# SPINDLE BEARINGS

## 1800HC/E, 1900HC/E, 100HC/E, 200HC/E

C: Contact Angle  $\alpha = 15^\circ$  / E: Contact Angle  $\alpha = 25^\circ$

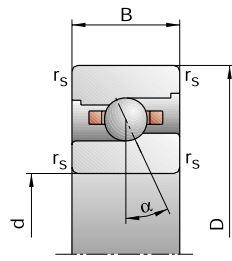

High Speed Design (ZSB)

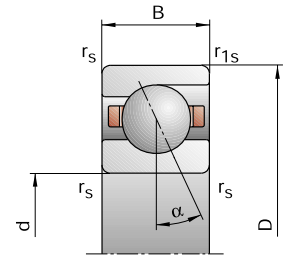

Standard Design



200  
-  
220

Attainable Speed*		Standard Preload $F_V$ (Force)			Unloading Force $K_{aE}$			Axial Rigidity $S_a$			Sealed Design	Weight	FAG Basic Bearing Number†		
Grease	Oil minimal	L	M	H	L	M	H	L	M	H		kg			
min <sup>-1</sup>		N											N/μm	kg	
4300	6300	355	1317	2817	1080	4320	9888	134.9	239.0	348.9	–	2.3	B71840C.TPA.P4		
3800	5600	428	1920	4319	1239	5728	13287	298.8	519.7	719.4	–	2.3	B71840E.TPA.P4		
5300	8000	191	806	1789	573	2565	6022	119.5	213.7	307.8	–	2.3	HCB71840C.TPA.P4		
4500	6700	177	1103	2659	514	3273	8073	249.5	477.0	665.9	–	2.3	HCB71840E.TPA.P4		
4000	6000	1133	3734	7704	3479	12312	27075	180.4	304.6	436.2	–	6.1	B71940C.T.P4S		
3600	5300	1643	5803	12213	4794	17453	37826	424.3	679.6	916.6	–	6.1	B71940E.T.P4S		
5000	7500	578	2027	4272	1747	6443	14237	156.1	258.7	361.2	–	5.1	HCB71940C.T.P4S		
4300	6300	761	3056	6660	2225	9111	20237	367.3	603.1	808.9	–	5.1	HCB71940E.T.P4S		
3600	5300	1805	5771	11787	5539	19000	41275	193.5	322.1	457.8	–	12.0	B7040C.T.P4S		
3200	4800	2730	9122	18891	7970	27422	58373	462.5	725.5	971.1	–	12.0	B7040E.T.P4S		
3200	4800	1916	6138	12545	5866	20139	43737	211.0	350.6	497.4	–	24.4	B7240C.T.P4S		
3000	4500	2901	9725	20159	8461	29193	62166	505.7	793.3	1061.0	–	24.4	B7240E.T.P4S		
3800	5600	358	1335	2861	1087	4366	10004	139.8	247.6	361.0	–	2.5	B71844C.TPA.P4		
3400	5000	427	1943	4384	1235	5789	13463	309.1	539.7	747.1	–	2.5	B71844E.TPA.P4		
4800	7000	191	815	1815	572	2587	6089	123.5	221.4	318.8	–	2.5	HCB71844C.TPA.P4		
4000	6000	166	1081	2630	482	3202	7987	253.1	489.9	685.9	–	2.5	HCB71844E.TPA.P4		
3600	5300	1191	3942	8140	3646	12940	28444	196.9	331.8	474.0	–	6.7	B71944C.T.P4S		
3200	4800	1714	6084	12867	4995	18257	39642	463.3	741.8	999.9	–	6.7	B71944E.T.P4S		
4500	6700	618	2176	4593	1861	6882	15259	171.7	284.2	396.9	–	5.6	HCB71944C.T.P4S		
3800	5600	799	3255	7114	2334	9694	21583	402.2	663.1	889.5	–	5.6	HCB71944E.T.P4S		
3200	4800	1916	6138	12545	5866	20139	43737	211.0	350.6	497.4	–	16.0	B7044C.T.P4S		
3000	4500	2901	9725	20159	8461	29193	62166	505.7	793.3	1061.0	–	16.0	B7044E.T.P4S		
2800	4300	2406	7621	15567	7360	24861	54043	225.4	371.1	525.7	–	33.6	B7244C.T.P4S		
2600	4000	3670	12081	24979	10706	36160	76950	542.6	843.8	1127.0	–	33.6	B7244E.T.P4S		

† FAG Basic Bearing Number is for reference only. All bearings are available exclusively from Barden, and must be ordered using the Barden Basic Bearing Number.

\* = speeds indicated are for spring preloads.

# SPINDLE BEARINGS

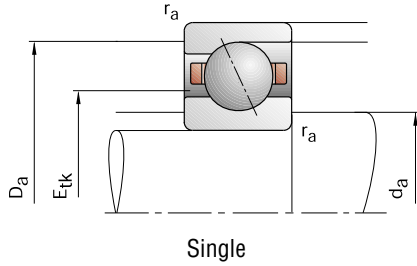

Single

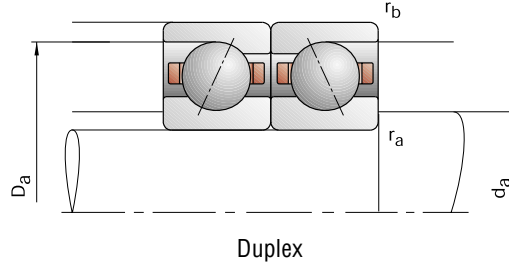

Duplex

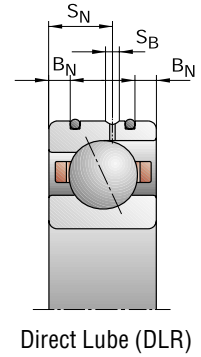

Direct Lube (DLR)

Barden Basic Bearing Number	Dimensions					Shaft & Shoulder Housing Dimensions				DLR Dimensions				Load Ratings		
	d	D	B	r <sub>smin</sub>	r <sub>1smin</sub>	d <sub>a</sub> h12	D <sub>a</sub> H12	r <sub>a</sub> max	r <sub>b</sub> max	B <sub>N</sub>	S <sub>N</sub>	S <sub>B</sub>	E <sub>tk</sub>	C <sub>dyn</sub>	C <sub>0stat</sub>	
	mm															kN
1848HC	240	300	28	2.00	1.00	253	287	2.0	1.0				262.8	106.00	150.00	
1848HE	240	300	28	2.00	1.00	253	287	2.0	1.0				262.8	98.00	140.00	
C1848HC	240	300	28	2.00	1.00	253	287	2.0	1.0				262.8	72.00	104.00	
C1848HE	240	300	28	2.00	1.00	253	287	2.0	1.0				262.8	68.00	96.50	
1948HC	240	320	38	2.10	1.10	254	307	1.0	1.0				272.4	224.00	310.00	
1948HE	240	320	38	2.10	1.10	254	307	1.0	1.0				272.4	212.00	285.00	
C1948HC	240	320	38	2.10	1.10	254	307	1.0	1.0				272.4	153.00	216.00	
C1948HE	240	320	38	2.10	1.10	254	307	1.0	1.0				272.4	146.00	200.00	
148HC	240	360	56	3.00	3.00	260	341	2.5	1.0				286.5	335.00	465.00	
148HE	240	360	56	3.00	3.00	260	341	2.5	1.0				286.5	315.00	440.00	
1952HC	260	360	46	2.10	1.10	278	342	1.0	1.0				300.5	285.00	415.00	
1952HE	260	360	46	2.10	1.10	278	342	1.0	1.0				300.5	270.00	390.00	
1956HC	280	380	46	2.10	1.10	298	362	1.0	1.0				320.5	300.00	450.00	
1956HE	280	380	46	2.10	1.10	298	362	1.0	1.0				320.5	280.00	425.00	
1960HC	300	420	56	3.00	1.10	322	398	1.5	1.0				348.6	360.00	570.00	
1960HE	300	420	56	3.00	1.10	322	398	1.5	1.0				348.6	340.00	540.00	
1964HC	320	440	56	3.00	1.10	342	418	1.5	1.0				368.6	375.00	620.00	
1964HE	320	440	56	3.00	1.10	342	418	1.5	1.0				368.6	355.00	585.00	
1968HC	340	460	56	3.00	1.10	362	438	1.5	1.0				388.6	380.00	640.00	
1968HE	340	460	56	3.00	1.10	362	438	1.5	1.0				388.6	360.00	610.00	
1972HC	360	480	56	3.00	1.10	382	458	1.5	1.0				408.6	390.00	695.00	
1972HE	360	480	56	3.00	1.10	382	458	1.5	1.0				408.6	375.00	640.00	
Designation examples:		Hybrid ceramic design														
Barden		C1948HCUL														
FAG		(HCB71948C.T.P4S.UL)														

# SPINDLE BEARINGS

## 1800HC/E, 1900HC/E

C: Contact Angle  $\alpha = 15^\circ$  / E: Contact Angle  $\alpha = 25^\circ$

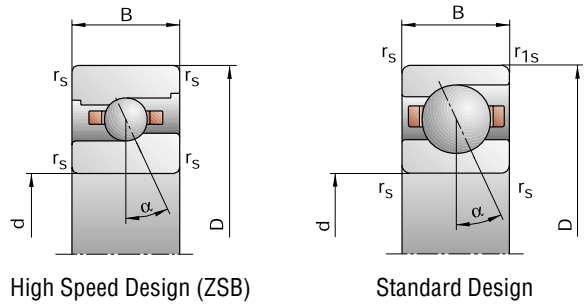

High Speed Design (ZSB)

Standard Design



240  
-  
360

Attainable Speed*		Standard Preload $F_V$ (Force)			Unloading Force $K_{aE}$			Axial Rigidity $S_a$			Sealed Design	Weight	FAG Basic Bearing Number†
Grease	Oil minimal	L	M	H	L	M	H	L	M	H		kg	
min <sup>-1</sup>		N						N/μm					
3400	5000	493	1763	3743	1501	5795	13170	156.0	272.7	397.0	–	3.9	B71848C.TPA.P4
3000	4500	613	2571	5687	1773	7681	17504	348.3	592.4	814.5	–	3.9	B71848E.TPA.P4
4300	6300	271	1084	2370	813	3448	7964	139.0	243.9	349.0	–	3.9	HCB71848C.TPA.P4
3600	5300	282	1519	3561	819	4515	10824	301.7	549.2	759.1	–	3.9	HCB71848E.TPA.P4
3200	4800	1230	4079	8431	3759	13355	29363	207.8	349.8	499.1	–	7.2	B71948C.T.P4S
3000	4500	1768	6303	13347	5149	18893	41059	489.6	784.5	1057.1	–	7.2	B71948E.T.P4S
4000	6000	632	2237	4729	1900	7059	15665	180.7	299.2	417.4	–	6.0	HCB71948C.T.P4S
3600	5300	794	3280	7196	2318	9755	21789	419.8	694.6	932.0	–	6.0	HCB71948E.T.P4S
3000	4500	1971	6321	12923	6028	20706	44965	219.7	364.8	517.2	–	17.0	B7048C.T.P4S
2800	4300	2933	9860	20455	8547	29565	62978	523.7	821.7	1098.4	–	17.0	B7048E.T.P4S
3000	4500	1625	5291	10870	4955	17278	37700	222.8	371.5	527.4	–	12.1	B71952C.T.P4S
2600	4000	2393	8255	17265	6977	24698	53045	530.5	838.7	1124.2	–	12.1	B71952E.T.P4S
2600	4000	1706	5562	11434	5196	18131	39565	237.5	395.6	561.2	–	12.9	B71956C.T.P4S
2400	3800	2463	8534	17870	7176	25504	54810	562.2	889.2	1191.1	–	12.9	B71956E.T.P4S
2400	3800	2097	6764	13849	6380	21926	47710	249.9	412.9	583.7	–	20.4	B71960C.T.P4S
2200	3600	3116	10570	21984	9061	31517	67389	598.5	938.7	1254.1	–	20.4	B71960E.T.P4S
2200	3600	2177	7017	14413	6612	22683	49487	265.7	437.8	618.7	–	21.6	B71964C.T.P4S
2000	3400	3235	11010	22920	9401	32795	70159	637.3	999.9	1335.1	–	21.6	B71964E.T.P4S
2200	3600	2061	6876	14282	6235	22142	48709	265.6	442.4	626.4	–	22.7	B71968C.T.P4S
1900	3200	2930	10616	22515	8516	31562	68780	630.3	1008.6	1354.6	–	22.7	B71968E.T.P4S
2000	3400	2101	7037	14635	6343	22593	49716	279.0	464.3	656.5	–	23.9	B71972C.T.P4S
1800	3000	3030	11025	23411	8803	32751	71437	666.9	1068.0	1434.0	–	23.9	B71972E.T.P4S

† FAG Basic Bearing Number is for reference only. All bearings are available exclusively from Barden, and must be ordered using the Barden Basic Bearing Number.

\* = speeds indicated are for spring preloads.

# NOTES

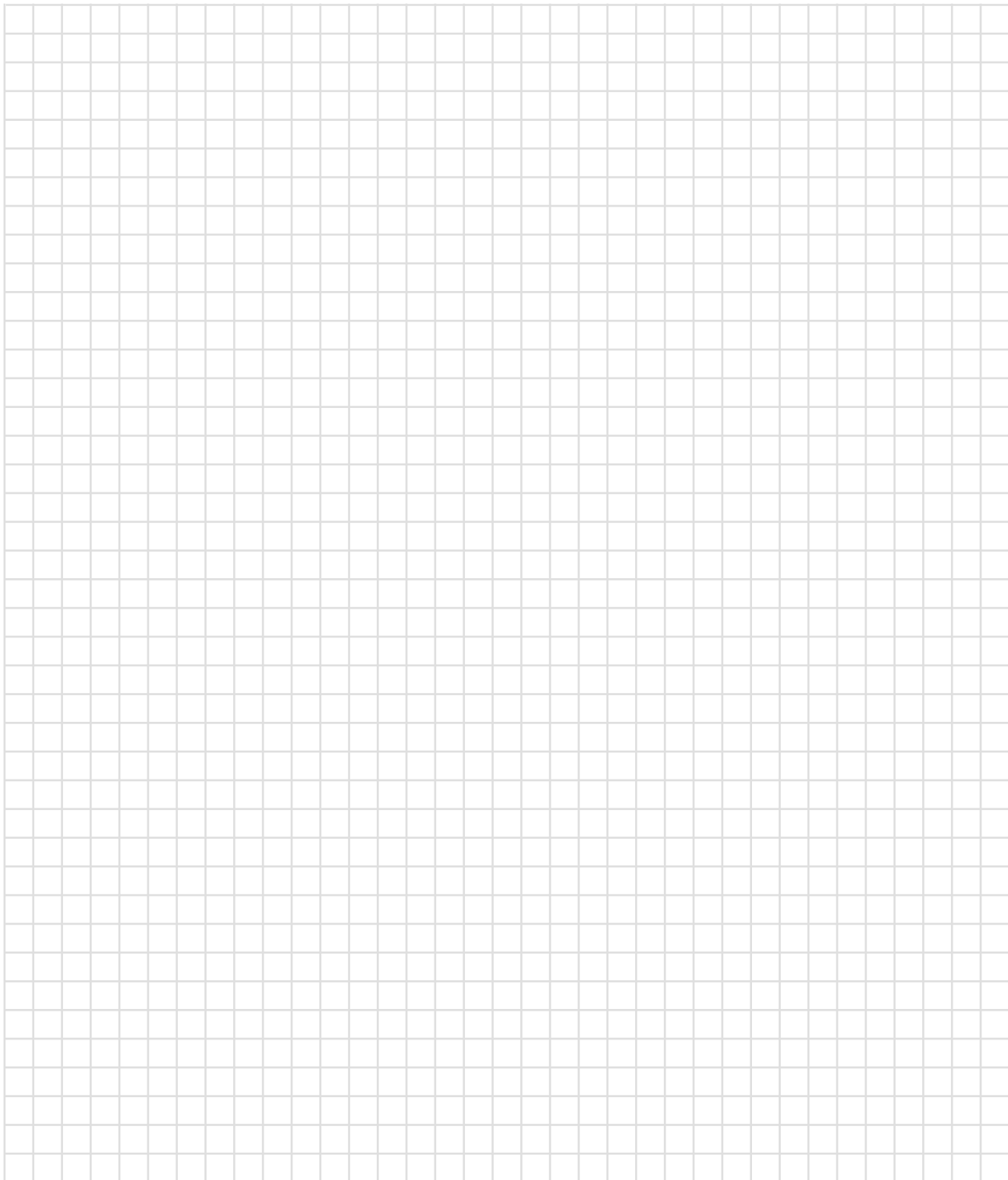

**FLOATING DISPLACEMENT BEARINGS**





## FLOATING DISPLACEMENT BEARINGS



The need to accommodate a “floating bearing” condition in some spindle designs is a well-documented problem. (A floating bearing condition is one where outer ring displacement occurs relative to the inner ring, which remains stable.) Simple designs have often meant a compromise between cost and performance. Advanced solutions,

while offering enhanced functional reliability, do so at significantly higher cost.

Barden/FAG developed Floating Displacement Bearings, (i.e. FD bearings), to provide an answer to the performance vs. cost dilemma. They were developed for use as floating bearings in motor spindles.

FD bearings consist of a deep groove ball bearing outer ring and a cylindrical roller bearing inner ring. This unique combination ensures free displacement of the outer ring and cage assembly relative to the inner ring during operation.

While combining two geometric design strategies into a single bearing

# BARDEN/FAG BEARING NOMENCLATURE FLOATING DISPLACEMENT BEARINGS

FD 10 10 T.P4S

**Bearing Type**

**FD** Floating Displacement bearing  
Ceramic balls

**Dimension Series**

**10** Medium series

**Bore Reference Number**

- 00** 10 mm
- 01** 12 mm
- 02** 15 mm
- 03** 17 mm
- 04** 4 · 5 = 20 mm
- 05** 5 · 5 = 25 mm

**Accuracy**

**P4S** FAG standard  
(ABEC 7 nominal tolerances,  
ABEC 9 running accuracies)

**Cage**

**T** Textile laminated phenolic resin cage  
Outer ring centered



is remarkable unto itself, the use of corrosion resistant, long life materials — like ceramic balls and Cronidur 30 high-performance steel — ensure a bearing design that offers tremendous functionality at a very cost-effective price over the life of the bearing.

FD bearings combine sufficient load carrying capacity with extremely high speedability, making them suitable for other applications requiring a floating bearing design.

All FD bearings exhibit the same external dimensions as 100 Series spindle bearings and N10 cylindrical roller bearings. They can be easily integrated into existing system configurations.



**FD bearings permit a sure and free displacement between inner and outer ring**

## FLOATING DISPLACEMENT BEARINGS

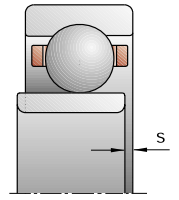
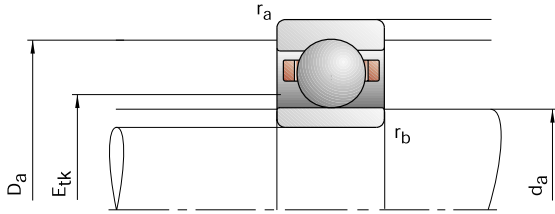

S = Maximum allowable axial travel

Barden Basic Bearing Number	Dimensions						Shaft & Shoulder Housing Dimensions				
	d	D	B	r <sub>smin</sub>	r <sub>1smin</sub>	s	d <sub>a</sub> h12	D <sub>a</sub> H12	r <sub>a</sub> max	r <sub>b</sub> max	E <sub>tk</sub>
	mm										
FD1000T.P4S	10	26	8	0.30	0.30	1.2	13.5	22.0	0.3	0.3	15.3
FD1001T.P4S	12	28	8	0.30	0.30	1.2	16.0	24.5	0.3	0.3	17.5
FD1002T.P4S	15	32	9	0.30	0.30	1.7	18.0	29.0	0.3	0.3	20.2
FD1003T.P4S	17	35	10	0.30	0.30	2.0	20.0	32.0	0.3	0.3	22.2
FD1004T.P4S	20	42	12	0.60	0.30	2.3	24.0	37.0	0.6	0.3	26.6
FD1005T.P4S	25	47	12	0.60	0.30	2.5	28.0	42.5	0.6	0.3	31.1
FD1006T.P4S	30	55	13	1.00	0.60	2.6	35.0	50.0	1.0	0.6	38.0
FD1007T.P4S	35	62	14	1.00	0.60	2.7	40.0	56.5	1.0	0.6	43.0
FD1008T.P4S	40	68	15	1.00	0.60	2.7	45.0	62.0	1.0	0.6	48.5
FD1009T.P4S	45	75	16	1.00	0.60	3.2	50.0	69.0	1.0	0.6	53.4
FD1010T.P4S	50	80	16	1.00	0.60	3.2	55.0	74.5	1.0	0.6	58.4
FD1011T.P4S	55	90	18	1.10	1.00	3.8	60.0	84.0	1.1	1.0	64.8
FD1012T.P4S	60	95	18	1.10	1.00	3.8	65.0	89.0	1.1	1.0	69.8
FD1013T.P4S	65	100	18	1.10	1.00	3.8	70.0	94.0	1.1	1.0	74.8
FD1014T.P4S	70	110	20	1.10	1.00	4.3	76.0	103.0	1.1	1.0	81.2
FD1015T.P4S	75	115	20	1.10	1.00	4.3	81.0	108.0	1.1	1.0	86.2
FD1016T.P4S	80	125	22	1.10	1.00	4.8	87.0	117.0	1.1	1.0	92.6
FD1017T.P4S	85	130	22	1.10	1.00	4.8	92.0	122.0	1.1	1.0	97.6
FD1018T.P4S	90	140	24	1.50	1.10	5.4	98.0	131.0	1.5	1.1	104.0

Designation example: FD1010T.P4S

# FLOATING DISPLACEMENT BEARINGS

## FD10

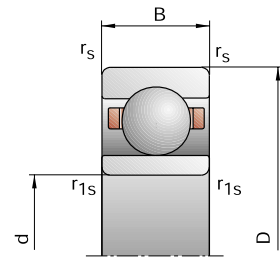

Load Ratings		Attainable Speed		Weight	FAG Basic Bearing Number <sup>†</sup>
C <sub>dyn</sub>	C <sub>0stat</sub>	Grease	Oil minimal		
kN		min <sup>-1</sup>		kg	
1.86	0.14	100000	170000	0.02	FD1000T.P4S
2.12	0.17	90000	150000	0.02	FD1001T.P4S
2.80	0.22	75000	120000	0.03	FD1002T.P4S
3.90	0.33	70000	110000	0.04	FD1003T.P4S
4.65	0.40	60000	90000	0.07	FD1004T.P4S
6.55	0.60	50000	75000	0.07	FD1005T.P4S
6.80	0.67	43000	63000	0.11	FD1006T.P4S
8.65	0.90	36000	53000	0.15	FD1007T.P4S
9.50	1.02	34000	50000	0.18	FD1008T.P4S
12.50	1.37	30000	45000	0.22	FD1009T.P4S
12.90	1.50	28000	43000	0.24	FD1010T.P4S
17.60	2.00	24000	38000	0.35	FD1011T.P4S
18.00	2.16	24000	38000	0.38	FD1012T.P4S
18.60	2.28	22000	36000	0.40	FD1013T.P4S
22.40	2.80	20000	34000	0.55	FD1014T.P4S
23.60	3.00	19000	32000	0.58	FD1015T.P4S
29.00	3.75	17000	28000	0.78	FD1016T.P4S
30.00	4.00	16000	26000	0.82	FD1017T.P4S
35.50	4.65	15000	24000	1.07	FD1018T.P4S

<sup>†</sup> FAG Basic Bearing Number is for reference only. All bearings are available exclusively from Barden, and must be ordered using the Barden Basic Bearing Number.



10  
90

# FLOATING DISPLACEMENT BEARINGS

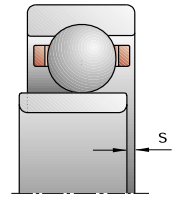
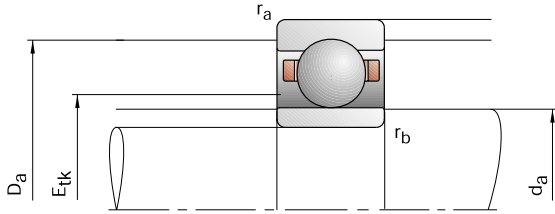

S = Maximum allowable axial travel

Barden Basic Bearing Number	Dimensions						Shaft & Shoulder Housing Dimensions				
	d	D	B	r <sub>smin</sub>	r <sub>1smin</sub>	s	d <sub>a</sub> h12	D <sub>a</sub> H12	r <sub>a</sub> max	r <sub>b</sub> max	E <sub>tk</sub>
	mm										
FD1019T.P4S	95	145	24	1.50	1.10	5.4	103.0	136.0	1.5	1.1	109.0
FD1020T.P4S	100	150	24	1.50	1.10	5.4	108.0	141.0	1.5	1.1	114.0
FD1021T.P4S	105	160	26	2.00	1.10	6.5	112.0	152.0	2.0	1.1	119.4
FD1022T.P4S	110	170	28	2.00	1.10	6.5	120.0	159.0	2.0	1.1	126.9
FD1024T.P4S	120	180	28	2.00	1.10	6.5	130.0	169.0	2.0	1.1	136.9
FD1026T.P4S	130	200	33	2.00	1.10	7.5	141.0	187.0	2.0	1.1	149.7
FD1028T.P4S	140	210	33	2.00	1.10	7.5	151.0	198.0	2.0	1.1	159.7
FD1030T.P4S	150	225	35	2.10	1.50	8.6	161.0	213.0	2.1	1.5	170.0
FD1032T.P4S	160	240	38	2.10	1.50	8.6	173.0	226.0	2.1	1.5	182.5

Designation example: FD1020T.P4S



# FLOATING DISPLACEMENT BEARINGS

## FD10

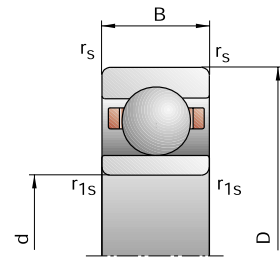

Load Ratings		Attainable Speed		Weight	FAG Basic Bearing Number <sup>†</sup>
C <sub>dyn</sub>	C <sub>0stat</sub>	Grease	Oil minimal	kg	
kN		min <sup>-1</sup>			
36.50	4.90	14000	22000	1.11	FD1019T.P4S
38.00	5.20	14000	22000	1.16	FD1020T.P4S
49.00	6.70	13000	20000	1.42	FD1021T.P4S
51.00	7.10	12000	19000	1.83	FD1022T.P4S
52.00	7.50	11000	18000	1.95	FD1024T.P4S
67.00	9.65	10000	17000	2.96	FD1026T.P4S
69.50	10.20	9000	15000	3.13	FD1028T.P4S
85.00	12.50	8500	14000	3.69	FD1030T.P4S
86.50	13.40	8000	13000	4.70	FD1032T.P4S



95  
160

<sup>†</sup> FAG Basic Bearing Number is for reference only. All bearings are available exclusively from Barden, and must be ordered using the Barden Basic Bearing Number.

# NOTES

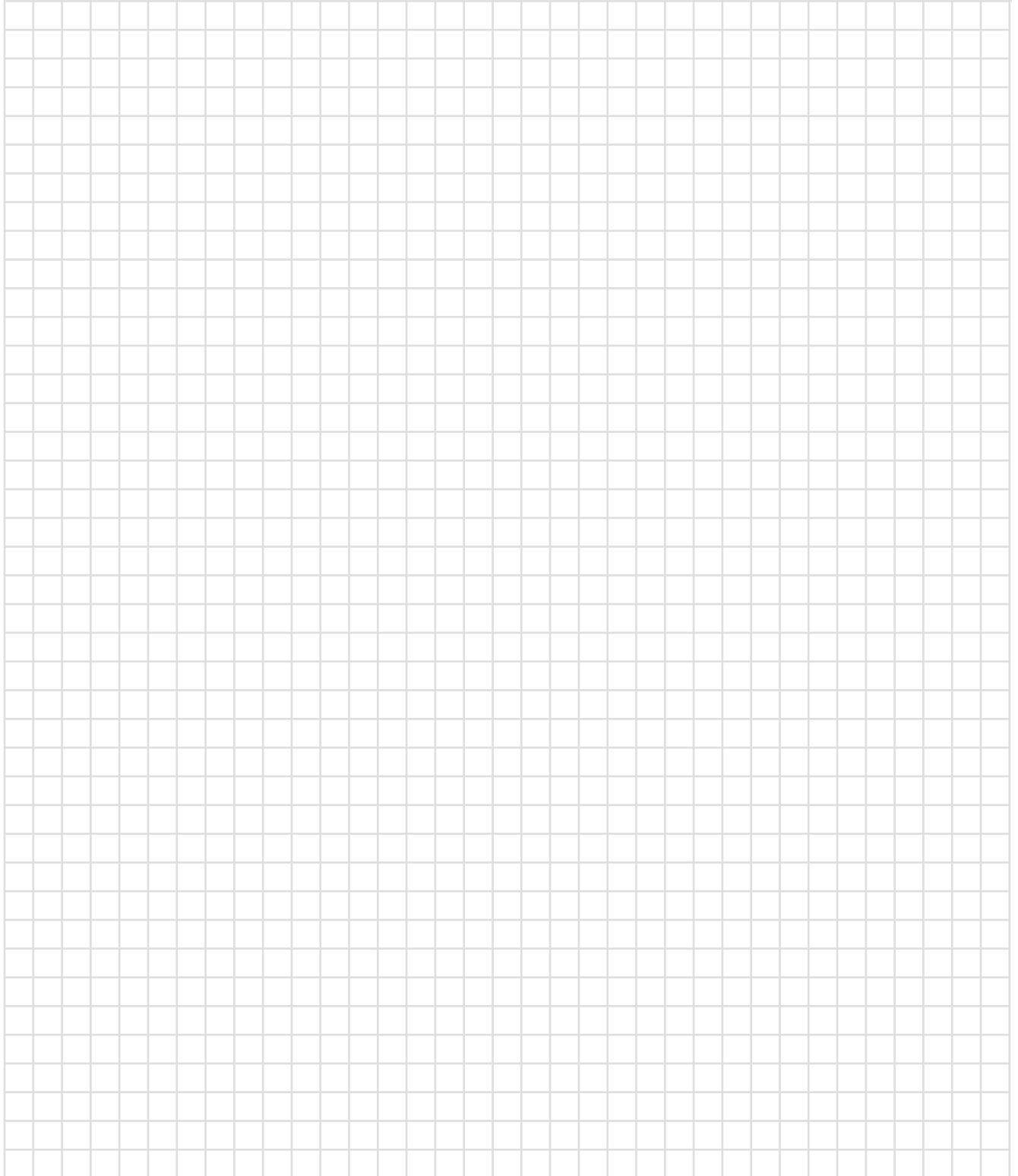

**SUPER PRECISION CYLINDRICAL ROLLER BEARINGS**



## CYLINDRICAL ROLLER BEARINGS



Super precision cylindrical roller bearings are designated as Series N10, NN30, N19 and NNU49.

NN30 double row bearings are typically used in combination with double direction angular contact thrust bearings in applications where radial stiffness, high radial capacity and high precision support is required. They represent the ideal solution for a floating bearing location, since they are internally adjusting (floating).

For axial loads, double direction angular contact thrust bearings, Series 2344 are used in combination with Series NN30 bearings.

A single row cylindrical roller bearing (Series N10, N19) would be most commonly used as the “floating” bearing

in combination with a set of preloaded angular contact spindle bearings.

Double row cylindrical roller bearings have a high load carrying capacity because of the high number of cylindrical rollers in each row, and the exclusive optimized roller crown profile which results in the best load distribution.

The cage is of solid machined brass construction, making this bearing suitable for rugged applications.

Single row cylindrical roller bearings also have a solid brass cage and are

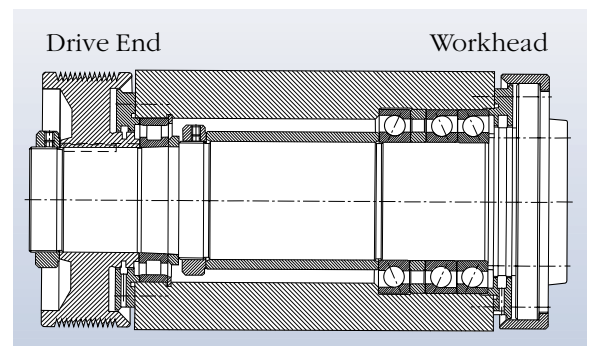

**Illustration shows a CNC spindle with a single row cylindrical roller bearing used in the drive end. A triplex set of angular contact ball bearings is used in the workhead end of the spindle. The combination provides high speed and precision machining capabilities with high radial load carrying capacity.**

specially designed for the demands of high speed spindles. They are available with both steel and ceramic rollers.

# BARDEN/FAG BEARING NOMENCLATURE SUPER PRECISION CYLINDRICAL ROLLER BEARINGS

N 10 20 K .M1 .SP  
HCN 10 20 K .M1 .SP  
N 19 20 K .M1 .SP

**Bearing type**

**N** Cylindrical roller bearing, single row  
Lips on inner ring, outer ring lipless  
**HCN** Hybrid cylindrical roller bearing, single row  
Ceramic rollers, lips on inner ring,  
Outer ring lipless

**Dimension Series**

**19** Light series  
**10** Medium series

**Bore Reference Number**

**06** 6 · 5 = 30 mm  
**08** 8 · 5 = 40 mm

**Accuracy**

**SP** Special Precision  
**UP** Ultra Precision

**Cage**

**M1** Brass cage, roller-centered

**Tapered Bore**

**K** Tapered bore (taper 1:12)

NNU 49 20 SK .M .SP  
NN 30 20 ASK .M .SP  
NN 30 20 ASK .M .SP

**Bearing Type**

**NNU** Cylindrical roller bearing, double row  
Lips on outer ring, inner ring lipless  
**NN** Cylindrical roller bearing, double row  
Lips on inner ring, outer ring lipless

**Dimension Series**

**49** Light series  
**30** Medium series

**Bore Reference Number**

**06** 6 · 5 = 30 mm  
**08** 8 · 5 = 40 mm

**Accuracy**

**SP** Special Precision  
**UP** Ultra Precision

**Cage**

**M** Brass cage, roller-centered

**Tapered Bore**

**K** Tapered bore (taper 1:12)

**External Form**

**S** Lubricating groove and holes  
on the outer ring  
**AS** Lubricating groove and holes  
on the outer ring (Series NN30)



The bearing bore is tapered (taper = 1: 12). The desired radial preload or radial clearance can be set by an axial adjustment on the conical shaft. Generally, the bearings should be mounted with zero clearance to a very slight preload.

Cylindricals generally have lower limiting speed than ball bearings. They are the limiting factor when used in conjunction with spindle bearings on the work end of a spindle.

Cylindrical roller bearings can be lubricated with either grease or oil.

Double row bearings feature a lubricating groove and lubricating hole in the middle of the outer ring.

Cylindrical roller bearings have a higher rigidity than comparable size angular contact ball bearings.

Hybrid cylindrical roller bearings — which feature rollers made from ceramic (silicon nitride) material — are now part of the standard Barden product line. The use of ceramic rollers offers significantly improved performance characteristics in terms of bearing friction and wear. For example, ceramic rollers operate at lower temperatures, thus reducing the demand on the lubricant. Consequently, higher speeds are permissible and the service life can be extended to a significant degree.

The higher static and dynamic rigidity characteristics of ceramic

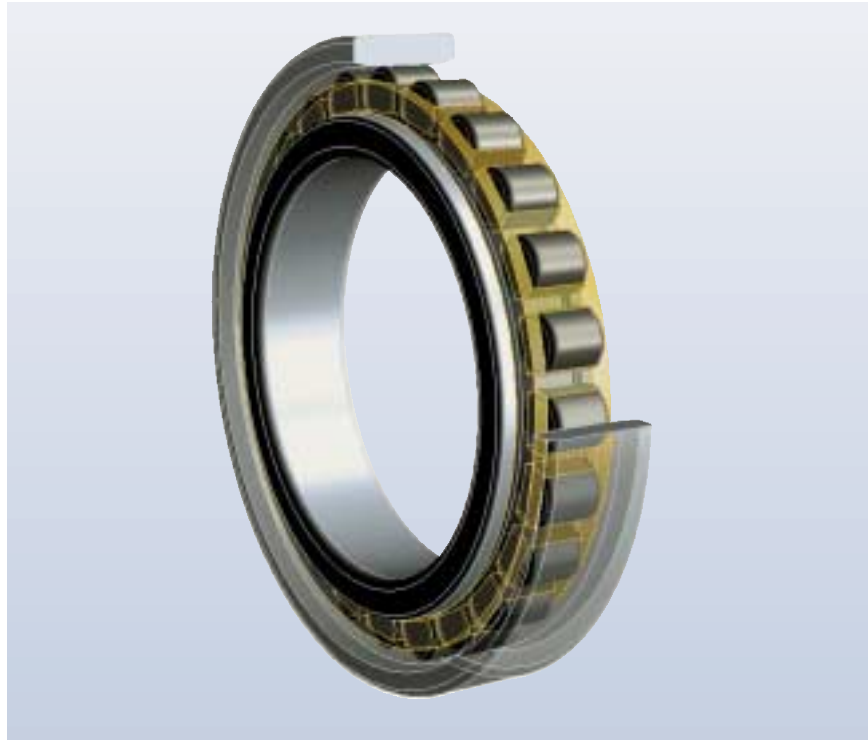

### Hybrid cylindrical roller bearings HCN series

rollers, coupled with a lower thermal expansion coefficient, means preload values can be lower under elevated temperature conditions.

Because of the high surface quality of ring raceways and rollers, FAG cylindrical roller bearings are particularly suited for grease lubrication.

In an oil lubrication system, cylindrical roller bearings have lower oil consumption requirements compared to angular contact ball bearings. Care must be taken to ensure that oil circuits are kept separate if these two bearing types are to be mounted side by side.

Excess cylindrical roller bearing lubrication due to oil flow “contamination” from adjacent angular contact ball bearings may cause a sharp increase in cylindrical roller bearing temperatures.



# SUPER PRECISION CYLINDRICAL ROLLER BEARINGS

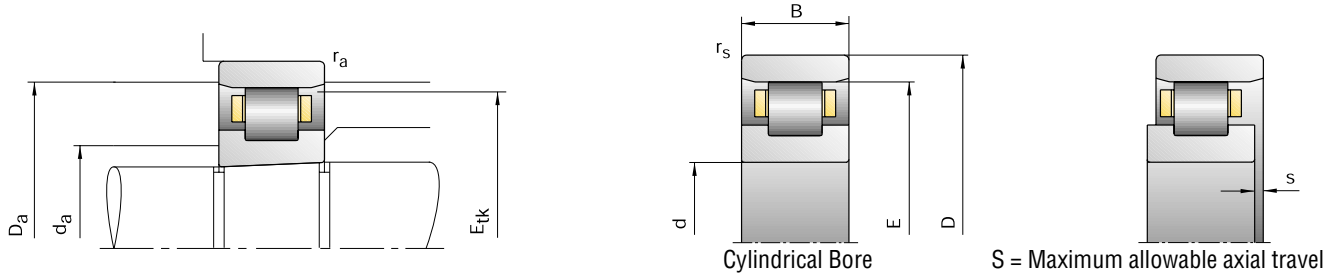

Barden Basic Bearing Number	Dimensions						Shaft & Shoulder Housing Dimensions			
	d	D	B	$r_{smin}$	E	s	$d_a$ h12	$D_a$ H12	$r_a$ max	$E_{tk}$
mm										
N1006K.M1.SP	30	55	13	0.60	48.5	1.9	36.5	49	0.60	47.0
HCN1006K.M1.SP	30	55	13	0.60	48.5	1.9	36.5	49	0.60	47.0
N1007K.M1.SP	35	62	14	0.60	55.0	2.0	42.0	56	0.60	53.4
HCN1007K.M1.SP	35	62	14	0.60	55.0	2.0	42.0	56	0.60	53.4
N1008K.M1.SP	40	68	15	0.60	61.0	2.1	47.0	62	0.60	59.3
HCN1008K.M1.SP	40	68	15	0.60	61.0	2.1	47.0	62	0.60	59.3
N1009K.M1.SP	45	75	16	0.60	67.5	2.2	52.5	69	0.60	65.6
HCN1009K.M1.SP	45	75	16	0.60	67.5	2.2	52.5	69	0.60	65.6
N1910K.M1.SP	50	72	12	0.60	66.5	1.8	55.5	67	0.60	65.1
N1010K.M1.SP	50	80	16	0.60	72.5	2.2	57.5	74	0.60	70.6
HCN1010K.M1.SP	50	80	16	0.60	72.5	2.2	57.5	74	0.60	70.6
N1911K.M1.SP	55	80	13	1.00	73.5	1.9	61.5	74	1.00	72.0
N1011K.M1.SP	55	90	18	1.00	80.5	2.5	64.5	82	1.00	78.5
HCN1011K.M1.SP	55	90	18	1.00	80.5	2.5	64.5	82	1.00	78.5
N1912K.M1.SP	60	85	13	1.00	78.5	1.9	66.5	79	1.00	77.0
N1012K.M1.SP	60	95	18	1.00	85.5	2.5	69.5	87	1.00	83.5
HCN1012K.M1.SP	60	95	18	1.00	85.5	2.5	69.5	87	1.00	83.5
N1913K.M1.SP	65	90	13	1.00	83.5	1.9	71.5	84	1.00	82.0
N1013K.M1.SP	65	100	18	1.00	90.5	2.5	74.5	92	1.00	88.5
HCN1013K.M1.SP	65	100	18	1.00	90.5	2.5	74.5	92	1.00	88.5
N1914K.M1.SP	70	100	16	1.00	92.0	2.3	78.0	93	1.00	90.3
N1014K.M1.SP	70	110	20	1.00	100.0	2.5	80.0	101	1.00	97.5
HCN1014K.M1.SP	70	110	20	1.00	100.0	2.5	80.0	101	1.00	97.5
N1915K.M1.SP	75	105	16	1.00	97.0	2.3	83.0	98	1.00	95.3
N1015K.M1.SP	75	115	20	1.00	105.0	2.5	85.0	106	1.00	102.5
HCN1015K.M1.SP	75	115	20	1.00	105.0	2.5	85.0	106	1.00	102.5
<b>Designation examples:</b>			<b>Standard design</b>				<b>Cylindrical bore</b>			
			N1014K.M1.SP				N1014M1.SP			
			N1914K.M1.SP				N1914M1.SP			

# SUPER PRECISION CYLINDRICAL ROLLER BEARINGS

## N19, N10, HCN10

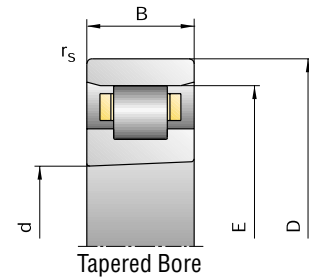

Load Ratings		Attainable Speed Grease	Oil minimal	Radial Stiffness $C_s$	Weight kg	FAG Basic Bearing Number <sup>†</sup>
$C_{dyn}$ kN	$C_{0stat}$ min <sup>-1</sup>					
20.40	20.40	19000	22000	330	0.13	N1006K.M1.SP
16.00	17.00	24000	28000		0.13	HCN1006K.M1.SP
23.60	24.50	16000	18000	410	0.17	N1007K.M1.SP
19.00	20.40	20000	24000		0.17	HCN1007K.M1.SP
27.50	29.00	15000	17000	440	0.22	N1008K.M1.SP
21.60	24.50	20000	24000		0.21	HCN1008K.M1.SP
34.50	39.00	13000	15000	500	0.27	N1009K.M1.SP
28.00	33.50	17000	19000		0.27	HCN1009K.M1.SP
22.40	27.50	13000	15000	470	0.15	N1910K.M1.SP
36.00	41.50	12000	14000	580	0.30	N1010K.M1.SP
28.50	34.50	16000	18000		0.30	HCN1010K.M1.SP
25.00	31.50	12000	14000	540		0.21 N1911K.M1.SP
41.50	50.00	11000	13000	650	0.44	N1011K.M1.SP
33.50	42.50	14000	16000		0.44	HCN1011K.M1.SP
26.00	34.00	11000	13000	580	0.22	N1912K.M1.SP
44.00	55.00	10000	12000	710	0.47	N1012K.M1.SP
35.50	46.50	13000	15000		0.47	HCN1012K.M1.SP
29.00	40.00	10000	12000	680	0.24	N1913K.M1.SP
45.00	58.50	9500	11000	740	0.50	N1013K.M1.SP
36.00	48.00	12000	14000		0.50	HCN1013K.M1.SP
36.50	49.00	9500	11000	710	0.38	N1914K.M1.SP
64.00	81.50	9000	10000	820	0.69	N1014K.M1.SP
52.00	68.00	12000	14000		0.69	HCN1014K.M1.SP
38.00	53.00	9000	10000	760	0.41	N1915K.M1.SP
65.50	85.00	8500	9500	850	0.73	N1015K.M1.SP
53.00	71.00	11000	13000		0.72	HCN1015K.M1.SP

### Hybrid design

HCN1014K.M1.SP

<sup>†</sup> FAG Basic Bearing Number is for reference only. All bearings are available exclusively from Barden, and must be ordered using the Barden Basic Bearing Number.



30  
75

# SUPER PRECISION CYLINDRICAL ROLLER BEARINGS

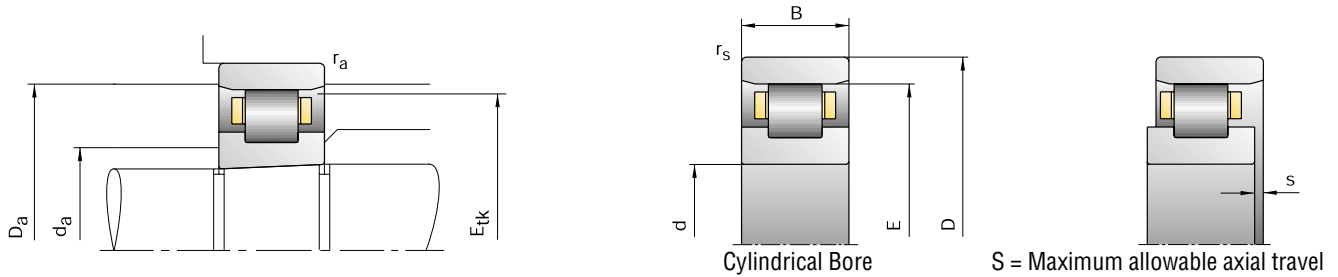

Barden Basic Bearing Number	Dimensions						Shaft & Shoulder Housing Dimensions			
	d	D	B	r <sub>smin</sub>	E	s	d <sub>a</sub> h12	D <sub>a</sub> H12	r <sub>a</sub> max	E <sub>tk</sub>
	mm									
N1916K.M1.SP	80	110	16	1.00	102.0	2.3	88.0	103	1.00	100.3
N1016K.M1.SP	80	125	22	1.00	113.5	3.0	91.5	115	1.00	110.8
HCN1016K.M1.SP	80	125	22	1.00	113.5	3.0	91.5	115	1.00	110.8
N1917K.M1.SP	85	120	18	1.00	110.5	2.5	94.5	112	1.00	108.5
N1017K.M1.SP	85	130	22	1.00	118.5	3.0	96.5	120	1.00	115.8
HCN1017K.M1.SP	85	130	22	1.00	118.5	3.0	96.5	120	1.00	115.8
N1918K.M1.SP	90	125	18	1.00	115.5	2.5	99.5	117	1.00	113.5
N1018K.M1.SP	90	140	24	1.10	127.0	3.2	103.0	129	1.10	124.0
HCN1018K.M1.SP	90	140	24	1.10	127.0	3.2	103.0	129	1.10	124.0
N1919K.M1.SP	95	130	18	1.00	120.5	2.5	104.5	122	1.00	118.5
N1019K.M1.SP	95	145	24	1.10	132.0	3.2	108.0	134	1.10	129.0
HCN1019K.M1.SP	95	145	24	1.10	132.0	3.2	108.0	134	1.10	129.0
N1920K.M1.SP	100	140	20	1.00	130.0	2.5	110.0	132	1.00	127.5
N1020K.M1.SP	100	150	24	1.10	137.0	3.2	113.0	139	1.10	134.0
HCN1020K.M1.SP	100	150	24	1.10	137.0	3.2	113.0	139	1.10	134.0
N1921K.M1.SP	105	145	20	1.00	135.0	2.5	115.0	137	1.00	132.5
N1021K.M1.SP	105	160	26	1.10	145.5	3.4	119.5	147	1.10	142.3
HCN1021K.M1.SP	105	160	26	1.10	145.5	3.4	119.5	147	1.10	142.3
N1922K.M1.SP	110	150	20	1.00	140.0	2.5	120.0	142	1.00	137.5
N1022K.M1.SP	110	170	28	1.10	155.0	3.4	125.0	157	1.10	151.3
HCN1022K.M1.SP	110	170	28	1.10	155.0	3.4	125.0	157	1.10	151.3
N1924K.M1.SP	120	165	22	1.00	153.5	3.0	131.5	156	1.00	150.8
N1024K.M1.SP	120	180	28	1.10	165.0	3.4	135.0	167	1.10	161.3
HCN1024K.M1.SP	120	180	28	1.10	165.0	3.4	135.0	167	1.10	161.3
N1926K.M1.SP	130	180	24	1.10	167.0	3.2	143.0	170	1.10	164.0
N1026K.M1.SP	130	200	33	1.10	182.0	4.2	148.0	184	1.10	177.8
Designation examples:			Standard design				Cylindrical bore			
			N1020K.M1.SP				N1020M1.SP			
			N1920K.M1.SP				N1920M1.SP			

# SUPER PRECISION CYLINDRICAL ROLLER BEARINGS

## N19, N10, HCN10

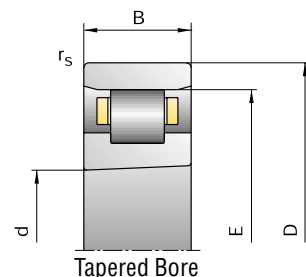

Load Ratings		Attainable Speed Grease	Oil minimal	Radial Stiffness $C_s$	Weight kg	FAG Basic Bearing Number <sup>†</sup>
$C_{dyn}$ kN	$C_{0stat}$ min <sup>-1</sup>					
39.00	56.00	8500	9500	810	0.43	N1916K.M1.SP
76.50	98.00	7500	8500	900	0.99	N1016K.M1.SP
61.00	83.00	10000	12000		0.98	HCN1016K.M1.SP
50.00	71.00	7500	8500	880	0.61	N1917K.M1.SP
78.00	104.00	7500	8500	940	1.04	N1017K.M1.SP
63.00	86.50	10000	12000		1.04	HCN1017K.M1.SP
51.00	75.00	7500	8500	930	0.64	N1918K.M1.SP
93.00	125.00	6700	7500	1030	1.34	N1018K.M1.SP
75.00	104.00	8500	9500		1.33	HCN1018K.M1.SP
52.00	78.00	7000	8000	960	0.67	N1919K.M1.SP
96.50	129.00	6300	7000	1070	1.40	N1019K.M1.SP
76.50	108.00	8000	9000		1.39	HCN1019K.M1.SP
78.00	112.00	6300	7000	1100	0.92	N1920K.M1.SP
98.00	134.00	6000	6700	1100	1.46	N1020K.M1.SP
78.00	114.00	8000	9000		1.45	HCN1020K.M1.SP
78.00	116.00	6000	6700	1140	0.96	N1921K.M1.SP
112.00	153.00	5600	6300	1160	1.82	N1021K.M1.SP
88.00	129.00	7500	8500		1.81	HCN1021K.M1.SP
80.00	120.00	6000	6700	1180	0.99	N1922K.M1.SP
140.00	190.00	5300	6000	1240	2.30	N1022K.M1.SP
112.00	160.00	7000	8000		2.29	HCN1022K.M1.SP
95.00	143.00	5300	6000	1270	1.36	N1924K.M1.SP
150.00	208.00	5000	5600	1340	2.47	N1024K.M1.SP
118.00	176.00	6700	7500		2.46	HCN1024K.M1.SP
110.00	170.00	4800	5300	1350	1.80	N1926K.M1.SP
180.00	250.00	4300	4800	1420	3.72	N1026K.M1.SP

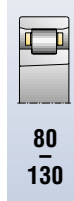

80  
-  
130

**Hybrid design**  
HCN1020K.M1.SP

<sup>†</sup> FAG Basic Bearing Number is for reference only. All bearings are available exclusively from Barden, and must be ordered using the Barden Basic Bearing Number.

# SUPER PRECISION CYLINDRICAL ROLLER BEARINGS

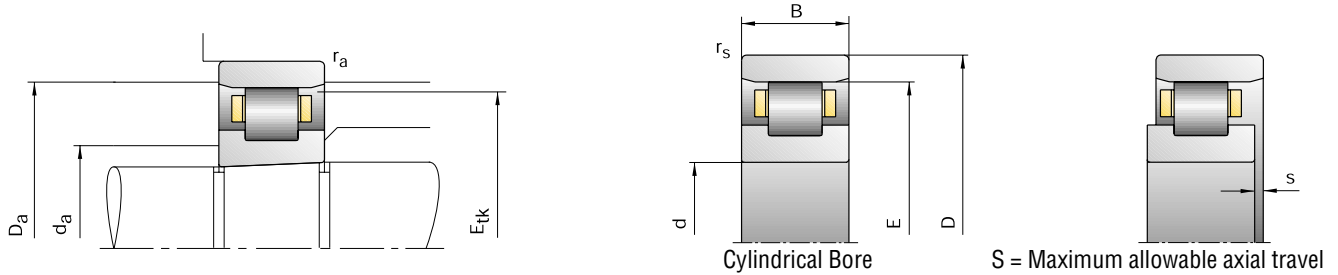

Barden Basic Bearing Number	Dimensions						Shaft & Shoulder Housing Dimensions			
	d	D	B	r <sub>smin</sub>	E	s	d <sub>a</sub> h12	D <sub>a</sub> H12	r <sub>a</sub> max	E <sub>tk</sub>
mm										
N1928K.M1.SP	140	190	24	1.10	177.0	3.2	153.0	180	1.10	174.0
N1028K.M1.SP	140	210	33	1.10	192.0	4.2	158.0	194	1.10	187.8
N1930K.M1.SP	150	210	28	1.10	194.0	3.6	166.0	197	1.10	190.5
N1030K.M1.SP	150	225	35	1.50	205.5	4.4	169.5	208	1.50	201.0
N1932K.M1.SP	160	220	28	1.10	204.0	3.6	176.0	206	1.10	200.5
N1032K.M1.SP	160	240	38	1.50	220.0	4.6	180.0	222	1.50	215.0
N1934K.M1.SP	170	230	28	1.10	214.0	3.6	186.0	216	1.10	210.5
N1034K.M1.SP	170	260	42	2.10	237.0	5.0	193.0	240	2.10	231.5
N1936K.M1.SP	180	250	33	1.10	232.0	4.2	198.0	234	1.10	227.8
N1036K.M1.SP	180	280	46	2.10	255.0	5.6	205.0	258	2.10	248.8
N1938K.M1.SP	190	260	33	1.10	242.0	4.2	208.0	244	1.10	237.8
N1038K.M1.SP	190	290	46	2.10	265.0	5.6	215.0	268	2.10	258.8
N1940K.M1.SP	200	280	38	1.50	259.0	4.8	221.0	261	1.50	254.3
N1040K.M1.SP	200	310	51	2.10	281.0	6.4	229.0	284	2.10	274.5
N1944K.M1.SP	220	300	38	1.50	279.0	4.8	241.0	281	1.50	274.3
N1044K.M1.SP	220	340	56	3.00	310.0	6.6	250.0	313	3.00	302.5
N1948K.M1.SP	240	320	38	1.50	299.0	4.8	261.0	301	1.50	294.3
N1048K.M1.SP	240	360	56	3.00	330.0	6.6	270.0	333	3.00	322.5
N1952K.M1.SP	260	360	46	1.50	334.0	5.4	286.0	336	1.50	328.0
N1052K.M1.SP	260	400	65	4.00	364.0	8.1	296.0	368	4.00	355.5
N1956K.M1.SP	280	380	46	1.50	354.0	5.4	306.0	356	1.50	348.0
N1056K.M1.SP	280	420	65	4.00	384.0	8.1	316.0	388	4.00	375.5
N1960K.M1.SP	300	420	56	3.00	390.0	6.6	330.0	392	3.00	382.5
N1060K.M1.SP	300	460	74	4.00	420.0	8.7	340.0	425	4.00	410.0
<b>Designation examples:</b>			<b>Standard design</b>				<b>Cylindrical bore</b>			
			N1030K.M1.SP				N1030M1.SP			
			N1930K.M1.SP				N1930M1.SP			

# SUPER PRECISION CYLINDRICAL ROLLER BEARINGS

## N19, N10, HCN10

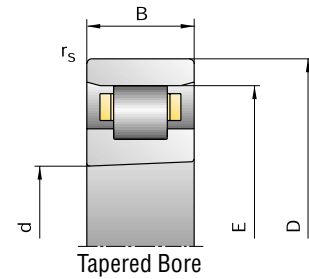

Load Ratings		Attainable Speed Grease	Oil minimal	Radial Stiffness $C_s$	Weight  kg	FAG Basic Bearing Number <sup>†</sup>
$C_{dyn}$  kN	$C_{0stat}$					
116.00	186.00	4300	4800	1480	1.92	N1928K.M1.SP
183.00	265.00	4000	4500	1480	3.94	N1028K.M1.SP
150.00	236.00	4000	4500	1590	2.95	N1930K.M1.SP
208.00	310.00	3800	4300	1630	4.75	N1030K.M1.SP
153.00	250.00	3800	4300	1690	3.10	N1932K.M1.SP
245.00	355.00	3400	3800	1680	5.79	N1032K.M1.SP
160.00	265.00	3400	3800	1780	3.26	N1934K.M1.SP
300.00	430.00	3200	3600	1860	7.77	N1034K.M1.SP
208.00	335.00	3200	3600	1880	4.81	N1936K.M1.SP
360.00	520.00	3000	3400	1960	10.20	N1036K.M1.SP
220.00	365.00	3000	3400	1990	5.05	N1938K.M1.SP
365.00	550.00	2800	3200	2040	10.60	N1038K.M1.SP
265.00	430.00	2800	3200	2110	7.07	N1940K.M1.SP
400.00	600.00	2600	3000	2130	14.00	N1040K.M1.SP
265.00	450.00	2600	3000	2170	7.64	N1944K.M1.SP
510.00	765.00	2400	2800	2360	17.90	N1044K.M1.SP
285.00	500.00	2400	2800	2430	8.24	N1948K.M1.SP
540.00	850.00	2200	2600	2560	19.30	N1048K.M1.SP
430.00	750.00	2000	2400	2840	14.00	N1952K.M1.SP
655.00	1020.00	1900	2200	2710	28.60	N1052K.M1.SP
440.00	800.00	1900	2200	3000	14.90	N1956K.M1.SP
680.00	1100.00	1800	2000	2930	30.90	N1056K.M1.SP
610.00	1060.00	1700	1900	3150	23.60	N1960K.M1.SP
900.00	1430.00	1600	1800	3200	43.70	N1060K.M1.SP



140  
300

**Hybrid design**  
HCN1030K.M1.SP

<sup>†</sup> FAG Basic Bearing Number is for reference only. All bearings are available exclusively from Barden, and must be ordered using the Barden Basic Bearing Number.

# SUPER PRECISION CYLINDRICAL ROLLER BEARINGS

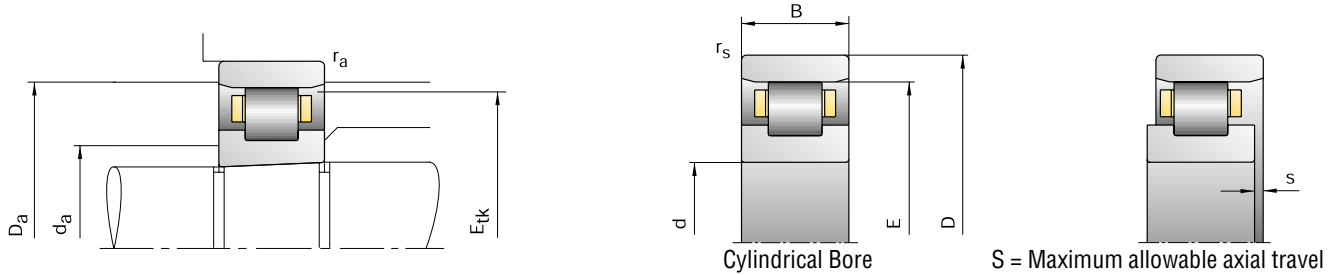

Barden Basic Bearing Number	Dimensions						Shaft & Shoulder Housing Dimensions			
	d	D	B	r <sub>smin</sub>	E	s	d <sub>a</sub> h12	D <sub>a</sub> H12	r <sub>a</sub> max	E <sub>tk</sub>
mm										
N1964K.M1.SP	320	440	56	3.00	410.0	6.6	350.0	412	3.00	402.5
N1064K.M1.SP	320	480	74	4.00	440.0	8.7	360.0	445	4.00	430.0
N1968K.M1.SP	340	460	56	3.00	430.0	6.6	370.0	433	3.00	422.5
N1068K.M1.SP	340	520	82	5.00	475.0	9.3	385.0	480	5.00	463.8
N1972K.M1.SP	360	480	56	3.00	450.0	6.6	390.0	453	3.00	442.5
N1072K.M1.SP	360	540	82	5.00	495.0	9.3	405.0	500	5.00	483.8
N1976K.M1.SP	380	520	65	4.00	484.0	8.1	416.0	487	4.00	475.5
N1076K.M1.SP	380	560	82	5.00	515.0	9.3	425.0	520	5.00	503.8
N1980K.M1.SP	400	540	65	4.00	504.0	8.1	436.0	507	4.00	495.5
N1080K.M1.SP	400	600	90	5.00	550.0	10.4	450.0	555	5.00	537.5
N1984K.M1.SP	420	560	65	4.00	524.0	8.1	456.0	527	4.00	515.5
N1084K.M1.SP	420	620	90	5.00	570.0	10.4	470.0	575	5.00	557.5
N1988K.M1.SP	440	600	74	4.00	558.0	9.1	482.0	562	4.00	548.5
N1088K.M1.SP	440	650	94	6.00	597.0	10.8	493.0	603	6.00	584.0
N1992K.M1.SP	460	620	74	4.00	578.0	9.1	502.0	582	4.00	568.5
N1092K.M1.SP	460	680	100	6.00	624.0	11.6	516.0	630	6.00	610.5
N1996K.M1.SP	480	650	78	5.00	605.0	9.5	525.0	609	5.00	595.0
N1096K.M1.SP	480	700	100	6.00	644.0	11.6	536.0	650	6.00	630.5
N19/500K.M1.SP	500	670	78	5.00	625.0	9.5	545.0	629	5.00	615.0
N10/500K.M1.SP	500	720	100	6.00	664.0	11.6	556.0	670	6.00	650.5

Designation examples:

Standard design

Cylindrical bore

N1064K.M1.SP

N1064M1.SP

N1964K.M1.SP

N1964M1.SP



# SUPER PRECISION CYLINDRICAL ROLLER BEARINGS

## N19, N10, HCN10

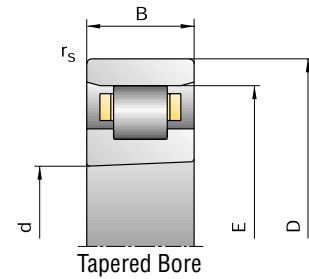

Load Ratings		Attainable Speed Grease	Oil minimal	Radial Stiffness $C_s$	Weight  kg	FAG Basic Bearing Number <sup>†</sup>
$C_{dyn}$  kN	$C_{0stat}$					
620.00	1100.00	1600	1800	3250	24.90	N1964K.M1.SP
915.00	1500.00	1500	1700	3330	45.10	N1064K.M1.SP
655.00	1200.00	1500	1700	3550	26.30	N1968K.M1.SP
1120.00	1830.00	1400	1600	3610	60.70	N1068K.M1.SP
655.00	1220.00	1400	1600	3640	27.50	N1972K.M1.SP
1140.00	1900.00	1300	1500	3750	64.40	N1072K.M1.SP
815.00	1500.00	1300	1500	3900	40.00	N1976K.M1.SP
1180.00	2000.00	1300	1500	3900	66.60	N1076K.M1.SP
815.00	1560.00	1300	1500	4010	41.70	N1980K.M1.SP
1370.00	2320.00	1200	1400	4090	88.10	N1080K.M1.SP
850.00	1630.00	1200	1400	4230	43.50	N1984K.M1.SP
1400.00	2450.00	1100	1300	4240	90.70	N1084K.M1.SP
1020.00	1960.00	1100	1300	4500	60.20	N1988K.M1.SP
1560.00	2750.00	1100	1300	4580	106.00	N1088K.M1.SP
1060.00	2080.00	1100	1300	4740	62.60	N1992K.M1.SP
1660.00	3000.00	1000	1200	4760	120.00	N1092K.M1.SP
1140.00	2240.00	1000	1200	4870	73.10	N1996K.M1.SP
1700.00	3100.00	950	1100	4840	125.00	N1096K.M1.SP
1180.00	2360.00	1000	1200	5100	75.70	N19/500K.M1.SP
1760.00	3200.00	950	1100	5100	130.00	N10/500K.M1.SP



320  
-  
500

**Hybrid design**  
HCN1064K.M1.SP

<sup>†</sup> FAG Basic Bearing Number is for reference only. All bearings are available exclusively from Barden, and must be ordered using the Barden Basic Bearing Number.

# SUPER PRECISION CYLINDRICAL ROLLER BEARINGS

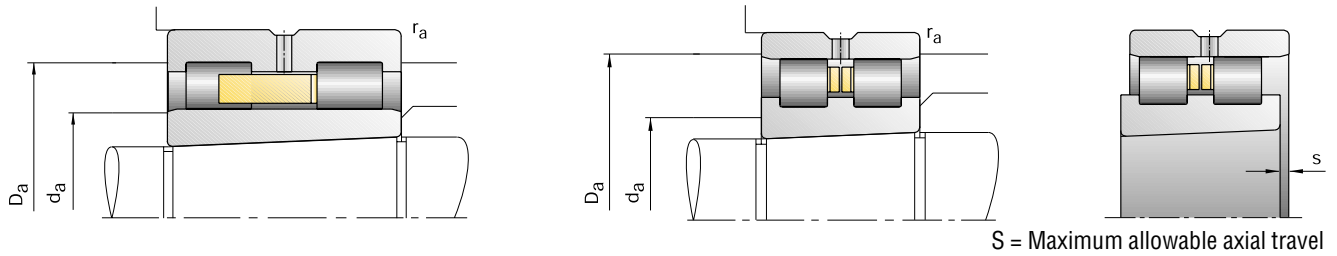

Barden Basic Bearing Number	Dimensions						Shaft & Shoulder Housing Dimensions					
	d	D	B	$r_{smin}$	E	s	$d_a$ h12	$D_a$ H12	$r_a$ max	$E_{tk}$		
mm												
NN3006ASK.M.SP	30	55	19	1.0	48.5	1.4	4.8	3.2	38	50	1.0	
NN3007ASK.M.SP	35	62	20	1.0	55.0	1.4	4.8	3.2	43	57	1.0	
NN3008ASK.M.SP	40	68	21	1.0	61.0	1.4	4.8	3.2	48	63	1.0	
NN3009ASK.M.SP	45	75	23	1.0	67.5	1.7	4.8	3.2	54	69	1.0	
NN3010ASK.M.SP	50	80	23	1.0	72.5	1.7	4.8	3.2	59	74	1.0	
NN3011ASK.M.SP	55	90	26	1.1	81.0	1.9	4.8	3.2	65	83	1.1	
NN3012ASK.M.SP	60	95	26	1.1	86.1	1.9	4.8	3.2	70	88	1.1	
NN3013ASK.M.SP	65	100	26	1.1	91.0	1.9	4.8	3.2	75	93	1.1	
NNU4914SK.M.SP	70	100	30	1.0		80.0	1.8	4.8	3.2	79	92	1.0
NN3014ASK.M.SP	70	110	30	1.1	100.0		2.3	6.5	3.2	82	102	1.1
NNU4915SK.M.SP	75	105	30	1.0		85.0	1.8	4.8	3.2	84	97	1.0
NN3015ASK.M.SP	75	115	30	1.1	105.0		2.3	6.5	3.2	87	107	1.1
NNU4916SK.M.SP	80	110	30	1.0		90.0	1.8	4.8	3.2	89	102	1.0
NN3016ASK.M.SP	80	125	34	1.1	113.0		2.5	6.5	3.2	93	116	1.1
NNU4917SK.M.SP	85	120	35	1.1		96.5	2.0	4.8	3.2	96	111	1.1
NN3017ASK.M.SP	85	130	34	1.1	118.0		2.5	6.5	3.2	98	121	1.1
NNU4918SK.M.SP	90	125	35	1.1		101.5	2.0	4.8	3.2	101	116	1.1
NN3018ASK.M.SP	90	140	37	1.5	127.0		2.6	6.5	3.2	105	130	1.5
NNU4919SK.M.SP	95	130	35	1.1		106.5	2.0	4.8	3.2	106	121	1.1
NN3019ASK.M.SP	95	145	37	1.5	132.0		2.6	6.5	3.2	110	135	1.5
NNU4920SK.M.SP	100	140	40	1.1		113.0	2.0	6.5	3.2	112	129	1.1
NN3020ASK.M.SP	100	150	37	1.5	137.0		2.6	6.5	3.2	115	140	1.5
<b>Designation examples:</b>			<b>Standard design</b>				<b>Cylindrical bore</b>					
			NNU4920SK.M.SP				NNU4920S.M.SP					
			NN3020ASK.M.SP				NN3020AS.M.SP					

# SUPER PRECISION CYLINDRICAL ROLLER BEARINGS

## NNU49, NN30

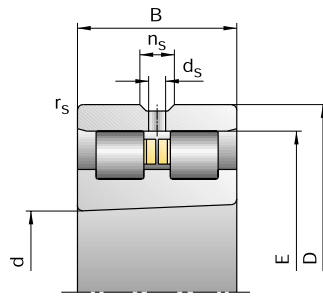

NN30 Series

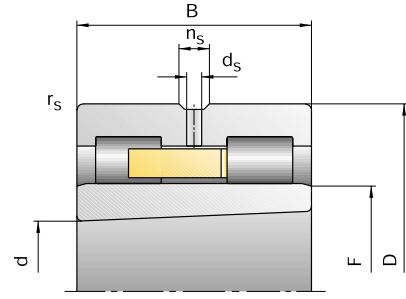

NNU49 Series

Load Ratings		Attainable Speed Grease	Oil minimal	Radial Stiffness $C_s$	Weight	FAG Basic Bearing Number <sup>†</sup>
$C_{dyn}$	$C_{0stat}$					
kN		min <sup>-1</sup>			kg	
29	34	16000	19000	680	0.19	NN3006ASK.M.SP
36	44	14000	17000	790	0.25	NN3007ASK.M.SP
45	59	12000	15000	950	0.30	NN3008ASK.M.SP
54	72	11000	14000	1080	0.39	NN3009ASK.M.SP
57	80	10000	13000	1180	0.43	NN3010ASK.M.SP
72	100	9000	11000	1300	0.63	NN3011ASK.M.SP
75	110	8500	10000	1410	0.67	NN3012ASK.M.SP
77	116	8000	9500	1470	0.72	NN3013ASK.M.SP
60	104	7500	9000	1700	0.73	NNU4914SK.M.SP
98	150	7000	8500	1660	1.04	NN3014ASK.M.SP
63	114	7000	8500	1870	0.77	NNU4915SK.M.SP
100	156	6700	8000	1730	1.09	NN3015ASK.M.SP
66	122	6700	8000	1980	0.81	NNU4916SK.M.SP
120	186	6300	7500	1850	1.51	NN3016ASK.M.SP
90	166	6300	7500	2280	1.20	NNU4917SK.M.SP
125	200	6000	7000	1990	1.58	NN3017ASK.M.SP
93	176	6000	7000	2420	1.26	NNU4918SK.M.SP
140	224	5600	6700	2020	2.05	NN3018ASK.M.SP
95	186	5600	6700	2560	1.32	NNU4919SK.M.SP
143	236	5300	6300	2100	2.14	NN3019ASK.M.SP
129	255	5300	6300	3000	1.86	NNU4920SK.M.SP
146	245	5300	6300	2170	2.23	NN3020ASK.M.SP

<sup>†</sup> FAG Basic Bearing Number is for reference only. All bearings are available exclusively from Barden, and must be ordered using the Barden Basic Bearing Number.

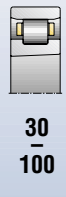

30  
100

# SUPER PRECISION CYLINDRICAL ROLLER BEARINGS

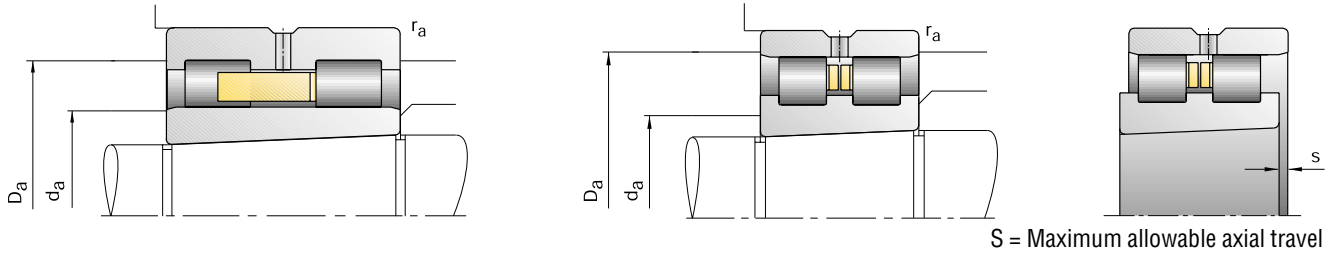

Barden Basic Bearing Number	Dimensions						Shaft & Shoulder Housing Dimensions					
	d	D	B	$r_{smin}$	E	s	$d_a$ h12	$D_a$ H12	$r_a$ max	$E_{tk}$		
	mm											
NNU4921SK.M.SP	105	145	40	1.1		118.0	2.0	6.5	3.2	117	134	1.1
NN3021ASK.M.SP	105	160	41	2.0	146.0		2.6	6.5	3.2	120	149	2.0
NNU4922SK.M.SP	110	150	40	1.1		123.0	2.0	6.5	3.2	122	139	1.1
NN3022ASK.M.SP	110	170	45	2.0	155.0		2.9	6.5	3.2	127	158	2.0
NNU4924SK.M.SP	120	165	45	1.1		134.5	2.3	6.5	3.2	133	155	1.1
NN3024ASK.M.SP	120	180	46	2.0	165.0		3.1	6.5	3.2	137	168	2.0
NNU4926SK.M.SP	130	180	50	1.5		146.0	2.7	6.5	3.2	145	166	1.5
NN3026ASK.M.SP	130	200	52	2.0	182.0		3.1	9.5	4.8	150	186	2.0
NNU4928SK.M.SP	140	190	50	1.5		156.0	1.8	6.5	3.2	155	176	1.5
NN3028ASK.M.SP	140	210	53	2.0	192.0		3.4	9.5	4.8	160	196	2.0
NNU4930SK.M.SP	150	210	60	2.0		168.5	2.7	6.5	3.2	167	197	2.0
NN3030ASK.M.SP	150	225	56	2.1	206.0		3.8	9.5	4.8	172	210	2.1
NNU4932SK.M.SP	160	220	60	2.0		178.5	2.7	6.5	3.2	177	207	2.0
NN3032ASK.M.SP	160	240	60	2.1	219.0		4.3	9.5	4.8	183	224	2.1
NNU4934SK.M.SP	170	230	60	2.0		188.5	2.7	6.5	3.2	187	217	2.0
NN3034ASK.M.SP	170	260	67	2.1	236.0		4.6	9.5	4.8	196	241	2.1
NNU4936SK.M.SP	180	250	69	2.0		202.0	3.2	9.5	4.8	200	232	2.0
NN3036ASK.M.SP	180	280	74	2.1	255.0		4.8	12.2	6.3	209	260	2.1
NNU4938SK.M.SP	190	260	69	2.0		212.0	3.2	9.5	4.8	210	242	2.0
NN3038ASK.M.SP	190	290	75	2.1	265.0		4.8	12.2	6.3	219	271	2.1
NNU4940SK.M.SP	200	280	80	2.1		225.0	4.3	12.2	6.3	223	259	2.1
NN3040ASK.M.SP	200	310	82	2.1	282.0		5.7	12.2	6.3	232	288	2.1
NNU4944SK.M.SP	220	300	80	2.1		245.0	4.3	12.2	6.3	243	279	2.1
NN3044ASK.M.SP	220	340	90	3.0	310.0		5.7	15.0	8.0	254	317	3.0
<b>Designation examples:</b>			<b>Standard design</b>					<b>Cylindrical bore</b>				
			NNU4930SK.M.SP					NNU4930S.M.SP				
			NN3030ASK.M.SP					NN3030AS.M.SP				

# SUPER PRECISION CYLINDRICAL ROLLER BEARINGS

## NNU49, NN30

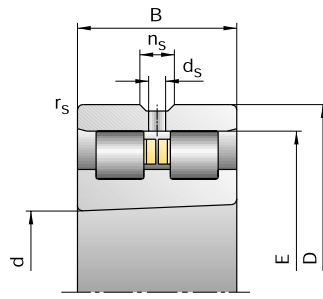

NN30 Series

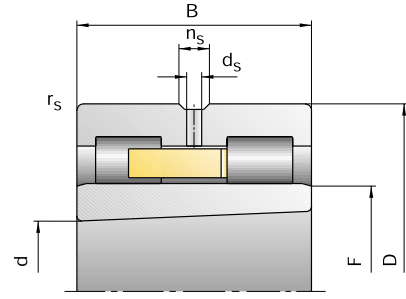

NNU49 Series

Load Ratings		Attainable Speed Grease	Oil minimal	Radial Stiffness $C_s$	Weight	FAG Basic Bearing Number <sup>†</sup>
$C_{dyn}$	$C_{0stat}$					
kN		$min^{-1}$			kg	
129	260	5300	6300	3080	1.93	NNU4921SK.M.SP
190	310	4800	5600	2320	2.84	NN3021ASK.M.SP
132	270	5000	6000	3170	2.01	NNU4922SK.M.SP
220	360	4500	5300	2500	3.61	NN3022ASK.M.SP
176	340	4500	5300	3200	2.71	NNU4924SK.M.SP
232	390	4300	5000	2700	3.94	NN3024ASK.M.SP
190	390	4000	4800	3600	3.73	NNU4926SK.M.SP
290	500	3800	4500	2980	5.79	NN3026ASK.M.SP
190	400	3800	4500	3700	4.04	NNU4928SK.M.SP
300	520	3600	4300	3090	6.22	NN3028ASK.M.SP
325	655	3600	4300	4280	6.10	NNU4930SK.M.SP
335	585	3400	4000	3300	7.58	NN3030ASK.M.SP
335	680	3400	4000	4420	6.41	NNU4932SK.M.SP
375	670	3200	3800	3510	9.23	NN3032ASK.M.SP
340	695	3200	3800	4560	6.73	NNU4934SK.M.SP
450	800	3000	3600	3770	12.50	NN3034ASK.M.SP
405	850	3000	3600	5160	9.96	NNU4936SK.M.SP
570	1000	2800	3400	4040	16.40	NN3036ASK.M.SP
405	880	2800	3400	5310	10.40	NNU4938SK.M.SP
585	1040	2600	3200	4190	17.30	NN3038ASK.M.SP
490	1040	2600	3200	5510	14.70	NNU4940SK.M.SP
655	1200	2400	3000	4410	22.20	NN3040ASK.M.SP
510	1140	2400	3000	6000	15.90	NNU4944SK.M.SP
800	1460	2200	2800	4770	29.10	NN3044ASK.M.SP



105  
220

<sup>†</sup> FAG Basic Bearing Number is for reference only. All bearings are available exclusively from Barden, and must be ordered using the Barden Basic Bearing Number.

# SUPER PRECISION CYLINDRICAL ROLLER BEARINGS

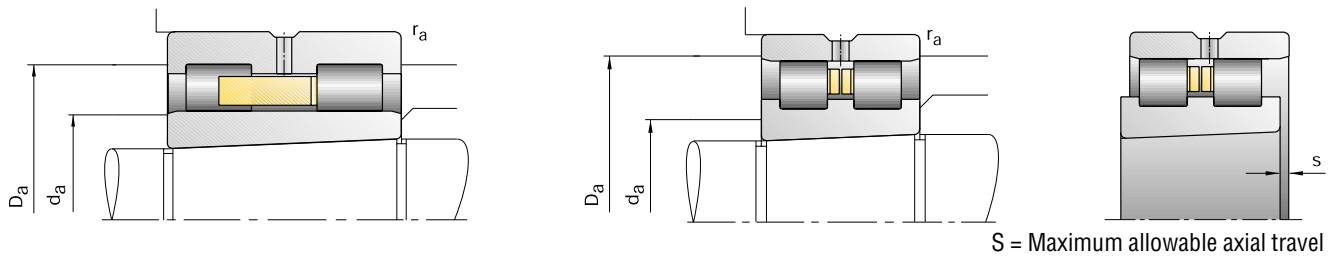

Barden Basic Bearing Number	Dimensions						Shaft & Shoulder Housing Dimensions					
	d	D	B	$r_{smin}$	E	s	$d_a$ h12	$D_a$ H12	$r_a$ max	$E_{tk}$		
mm												
NNU4948SK.M.SP	240	320	80	2.1		265.0	4.3	12.2	6.3	263	299	2.1
NN3048ASK.M.SP	240	360	92	3.0	330.0		6.1	15.0	8.0	274	337	3.0
NNU4952SK.M.SP	260	360	100	2.1		292.0	5.4	15.0	8.0	289	334	2.1
NN3052ASK.M.SP	260	400	104	4.0	364.0		6.6	15.0	8.0	300	372	4.0
NNU4956SK.M.SP	280	380	100	2.1		312.0	5.4	15.0	8.0	309	354	2.1
NN3056ASK.M.SP	280	420	106	4.0	384.0		6.9	15.0	8.0	320	392	4.0
NNU4960SK.M.SP	300	420	118	3.0		339.0	6.3	17.7	9.5	336	389	3.0
NN3060ASK.M.SP	300	460	118	4.0	418.0		7.5	17.7	9.5	346	427	4.0
NNU4964SK.M.SP	320	440	118	3.0		359.0	6.3	17.7	9.5	356	409	3.0
NN3064ASK.M.SP	320	480	121	4.0	438.0		8.0	17.7	9.5	366	447	4.0
NNU4968SK.M.SP	340	460	118	3.0		379.0	6.3	17.7	9.5	376	429	3.0
NN3068ASK.M.SP	340	520	133	5.0	473.0		8.8	17.7	9.5	393	483	5.0
NNU4972SK.M.SP	360	480	118	3.0		399.0	6.3	17.7	9.5	396	449	3.0
NN3072ASK.M.SP	360	540	134	5.0	493.0		8.8	17.7	9.5	413	503	5.0
NNU4976SK.M.SP	380	520	140	4.0		426.0	7.2	17.7	9.5	423	482	4.0
NN3076ASK.M.SP	380	560	135	5.0	513.0		9.1	17.7	9.5	433	523	5.0
NNU4980SK.M.SP	400	540	140	4.0		446.0	7.2	17.7	9.5	443	502	4.0
NN3080ASK.M.SP	400	600	148	5.0	549.0		9.5	17.7	9.5	459	560	5.0
NNU4984SK.M.SP	420	560	140	4.0		466.0	7.2	17.7	9.5	463	522	4.0
NN3084ASK.M.SP	420	620	150	5.0	569.0		10.0	17.7	9.5	479	580	5.0
NNU4988SK.M.SP	440	600	160	4.0		490.0	6.8	17.7	9.5	487	558	4.0
NN3088ASK.M.SP	440	650	157	6.0	597.0		10.2	23.5	12.5	501	609	6.0
NNU4992SK.M.SP	460	620	160	4.0		510.0	6.8	17.7	9.5	507	578	4.0
NN3092ASK.M.SP	460	680	163	6.0	624.0		10.9	23.5	12.5	524	636	6.0
<b>Designation examples:</b>			<b>Standard design</b>					<b>Cylindrical bore</b>				
			NNU4960SK.M.SP					NNU4960S.M.SP				
			NN3060ASK.M.SP					NN3060AS.M.SP				

# SUPER PRECISION CYLINDRICAL ROLLER BEARINGS

## NNU49, NN30

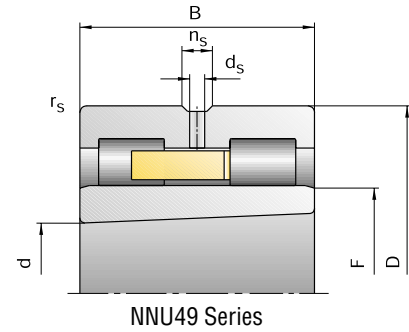
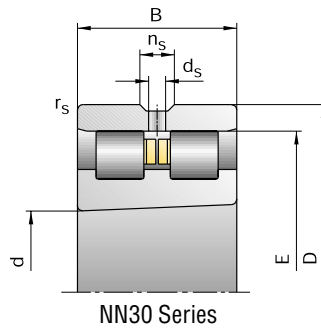

Load Ratings		Attainable Speed Grease	Oil minimal	Radial Stiffness $C_s$	Weight	FAG Basic Bearing Number <sup>†</sup>
$C_{dyn}$	$C_{0stat}$					
kN		$min^{-1}$			kg	
530	1200	2200	2800	6320	17.10	NNU4948SK.M.SP
850	1560	2000	2600	5140	31.60	NN3048ASK.M.SP
750	1700	2000	2600	7080	29.70	NNU4952SK.M.SP
1060	2000	1900	2400	5680	46.20	NN3052ASK.M.SP
765	1800	1900	2400	7480	31.60	NNU4956SK.M.SP
1080	2080	1800	2200	5890	49.70	NN3056ASK.M.SP
1040	2400	1700	2000	8280	49.10	NNU4960SK.M.SP
1270	2400	1600	1900	5930	68.80	NN3060ASK.M.SP
1060	2550	1600	1900	8750	51.80	NNU4964SK.M.SP
1320	2600	1600	1900	6440	74.20	NN3064ASK.M.SP
1100	2650	1500	1800	9230	54.50	NNU4968SK.M.SP
1630	3250	1400	1700	7170	99.30	NN3068ASK.M.SP
1140	2800	1500	1800	9700	57.30	NNU4972SK.M.SP
1660	3350	1400	1700	7430	104	NN3072ASK.M.SP
1430	3600	1400	1700	10970	85.80	NNU4976SK.M.SP
1700	3450	1300	1600	7690	110	NN3076ASK.M.SP
1500	3800	1300	1600	11540	89.40	NNU4980SK.M.SP
2160	4500	1200	1500	8660	143	NN3080ASK.M.SP
1530	4000	1300	1600	12120	93.20	NNU4984SK.M.SP
2120	4500	1200	1500	8660	150	NN3084ASK.M.SP
2040	5200	1200	1500	12690	129	NNU4988SK.M.SP
2450	5100	1100	1400	9240	172	NN3088ASK.M.SP
2120	5500	1100	1400	13390	134	NNU4992SK.M.SP
2600	5400	1100	1400	9430	197	NN3092ASK.M.SP

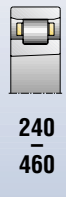

<sup>†</sup> FAG Basic Bearing Number is for reference only. All bearings are available exclusively from Barden, and must be ordered using the Barden Basic Bearing Number.



# SUPER PRECISION CYLINDRICAL ROLLER BEARINGS

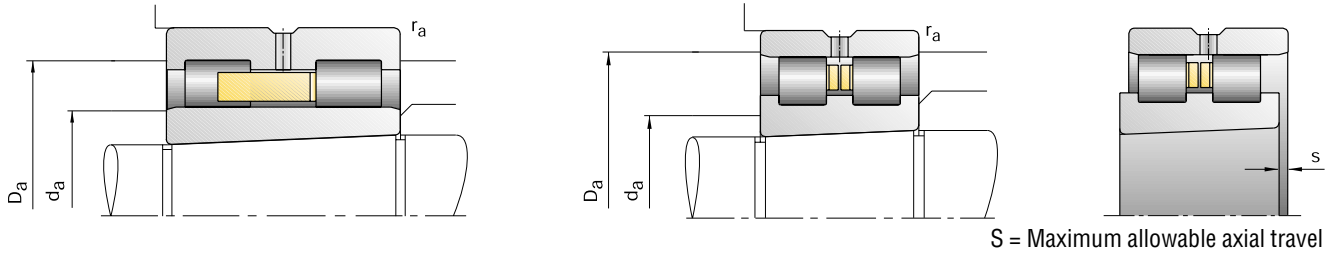

Barden Basic Bearing Number	Dimensions							Shaft & Shoulder Housing Dimensions				
	d	D	B	$r_{smin}$	E	s	$d_a$ h12	$D_a$ H12	$r_a$ max	$E_{tk}$		
	mm											
NNU4996SK.M.SP	480	650	170	5.0		534.0	7.2	17.7	9.5	531	606	5.0
NN3096ASK.M.SP	480	700	165	6.0	644.0		11.2	23.5	12.5	544	656	6.0
NNU49/500SK.M.SP	500	670	170	5.0		568.0	7.2	17.7	9.5	551	626	5.0
NN30/500ASK.M.SP	500	720	167	6.0	664.0		11.7	23.5	12.5	564	677	6.0

# SUPER PRECISION CYLINDRICAL ROLLER BEARINGS

## NNU49, NN30

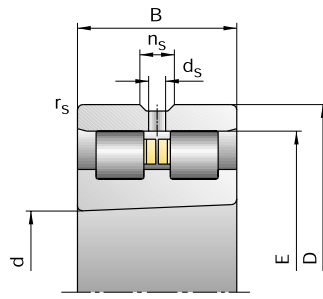

NN30 Series

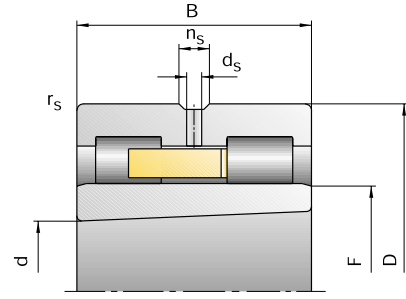

NNU49 Series

Load Ratings		Attainable Speed Grease	Oil minimal	Radial Stiffness $C_s$	Weight kg	FAG Basic Bearing Number <sup>†</sup>
$C_{dyn}$	$C_{0stat}$					
kN		$min^{-1}$				
2360	6100	1100	1400	14110	158	NNU4996SK.M.SP
2700	5850	1000	1300	10060	206	NN3096ASK.M.SP
2320	6100	1000	1300	14110	162	NNU49/500SK.M.SP
2650	5850	1000	1300	10060	214	NN30/500ASK.M.SP



480  
—  
500

<sup>†</sup> FAG Basic Bearing Number is for reference only. All bearings are available exclusively from Barden, and must be ordered using the Barden Basic Bearing Number.

# NOTES

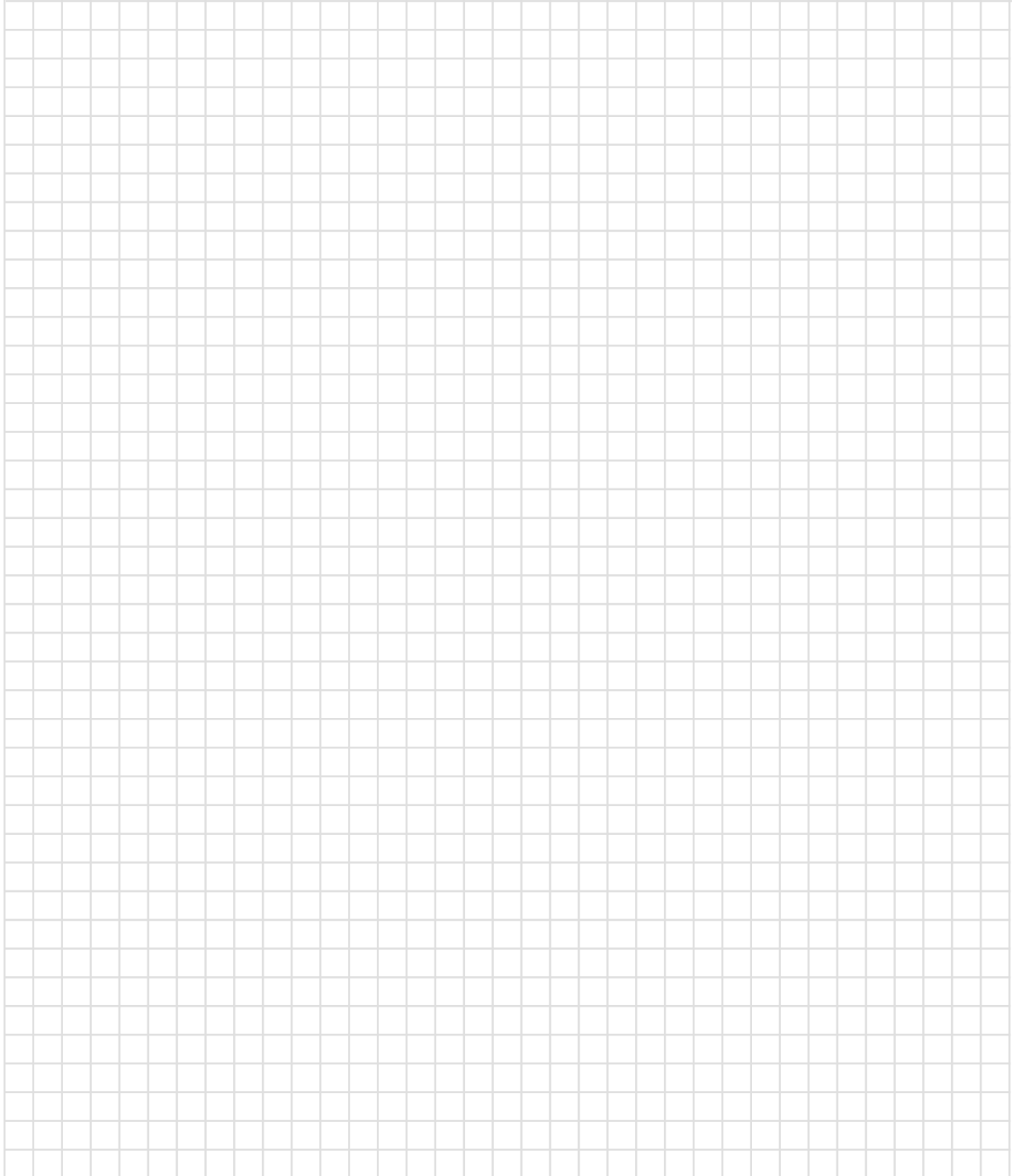

**DOUBLE DIRECTION ANGULAR CONTACT THRUST BALL BEARINGS**



## DOUBLE DIRECTION ANGULAR CONTACT THRUST BALL BEARINGS



Double direction angular contact thrust ball bearings are designed for use in machine tool spindles, in combination with cylindrical roller bearings. They are manufactured to precision tolerances. Double direction angular contact thrust ball bearings are designed to carry only thrust loads. They match the mounting dimensions of the NN30 Series double row cylindrical roller bearings which carry the bearing load.

Double direction angular contact thrust ball bearings are designed to be mounted in conjunction with a double row radial cylindrical roller bearing. The nominal size of the outside diameter is the same for both bearings which simplifies the machining of the housing bore. The outside diameter tolerance of the double direction angular contact thrust ball bearing is designed so that there is clearance between the bearing O.D. and the

housing bore. Use of this bearing type, in combination with a double row cylindrical roller bearing, offers the advantage of supporting both axial and radial forces separately.

Double direction angular contact thrust ball bearings have a contact angle of  $60^\circ$  and are axially preloaded. The contact angle and the axial preload ensures good ball control, especially under the centrifugal forces with fast rotating spindles. These bearings are designed to accommodate high thrust loads. They have solid one piece machined brass cages which are ball guided.

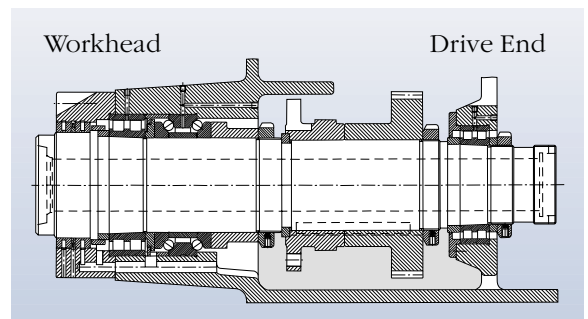

**This illustration of a heavy-duty lathe spindle shows typical placement of a double direction angular contact thrust ball bearing used in combination with a double row cylindrical roller bearing in the workhead. The drive end of the spindle features one double row cylindrical bearing. This combination allows the spindle to operate with high rigidity, while accommodating both axial and radial loads.**

Speed limit values for grease and oil lubrication are given in the bearing tables beginning on page 120.

# BARDEN/FAG BEARING NOMENCLATURE DOUBLE DIRECTION ANGULAR CONTACT THRUST BALL BEARINGS

2344 24 M .SP

**Series designation**

**2344** For mounting at small-end taper  
**2347** For mounting at large-end taper

**Bore Reference Number**

**06**     $6 \cdot 5 = 30$  mm  
**10**     $10 \cdot 5 = 50$  mm

**Accuracy**

**SP**    Special Precision  
**UP**    Ultra Precision

**Cage**

**M**    Brass cage





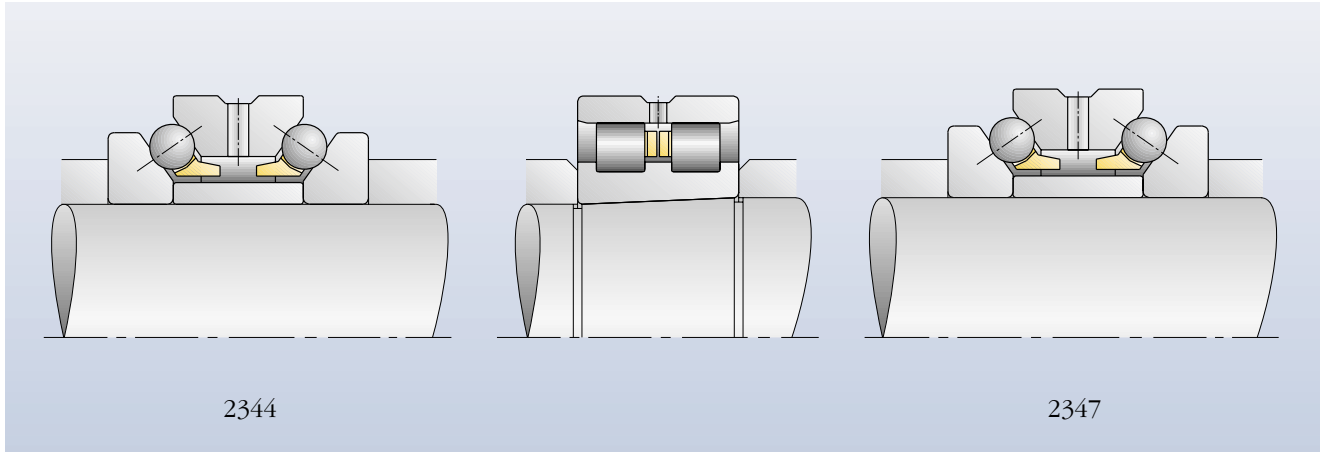

**Orientation of double direction angular contact thrust ball bearings of series 2344 and 2347 in relation to double row cylindrical roller bearings**

FAG double direction angular contact thrust ball bearings can be lubricated with either grease or oil. The outer ring O.D. has a lubricating groove in the center with lubricating holes. The application of the lubricant between the two rows of balls allows optimal distribution of lubricant to both raceways.

For optimum performance, machine tool spindle bearings must exhibit high rigidity as well as high precision. This means that they must run precisely and must allow only slight deflection under load. The double direction angular contact thrust ball bearings achieve high axial rigidity

through their internal design with 60° contact angle and a defined heavy preload.

**Lubrication**

FAG angular contact thrust ball bearings can be either grease or oil lubricated. The housing washer design in the bearing features a lubrication groove and lubrication holes at the center.

The lubricant supply between the two rows of balls is rapidly dispersed by the centrifugal force of the bearing. For this reason double direction angular contact

thrust ball bearings require a considerably greater amount of oil than an adjacent cylindrical roller bearing. At the design stage, attention should be paid to the fact that excess oil flow should not compromise the lesser lubrication requirements of cylindrical roller bearings.

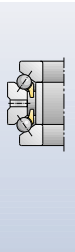

## DOUBLE DIRECTION ANGULAR CONTACT THRUST BALL BEARINGS

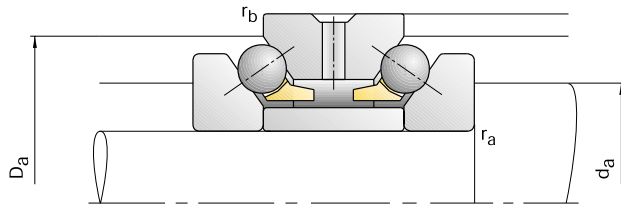

Barden Basic Bearing Number	Dimensions										Shaft & Shoulder Housing Dimensions			
	d	D	B	r <sub>smin</sub>	r <sub>1smin</sub>	d <sub>1</sub>	B <sub>i</sub>	B <sub>a</sub>	n <sub>s</sub>	d <sub>s</sub>	d <sub>a</sub> h12	D <sub>a</sub> H12	r <sub>a</sub> max	r <sub>b</sub> max
mm														
234406M.SP	30	55	32	1.00	0.15	47.0	8.0	16	4.8	3.2	40.5	50.5	1.00	0.15
234706M.SP	32	55	32	1.00	0.15	47.0	8.0	16	4.8	3.2	40.5	50.5	1.00	0.15
234407M.SP	35	62	34	1.00	0.15	53.0	8.5	17	4.8	3.2	46.5	57.0	1.00	0.15
234707M.SP	37	62	34	1.00	0.15	53.0	8.5	17	4.8	3.2	46.5	57.0	1.00	0.15
234408M.SP	40	68	36	1.00	0.15	58.5	9.0	18	4.8	3.2	51.5	63.5	1.00	0.15
234708M.SP	42	68	36	1.00	0.15	58.5	9.0	18	4.8	3.2	51.5	63.5	1.00	0.15
234409M.SP	45	75	38	1.00	0.15	65.0	9.5	19	4.8	3.2	57.5	70.0	1.00	0.15
234709M.SP	47	75	38	1.00	0.15	65.0	9.5	19	4.8	3.2	57.5	70.0	1.00	0.15
234410M.SP	50	80	38	1.00	0.15	70.0	9.5	19	4.8	3.2	62.5	75.0	1.00	0.15
234710M.SP	52	80	38	1.00	0.15	70.0	9.5	19	4.8	3.2	62.5	75.0	1.00	0.15
234411M.SP	55	90	44	1.10	0.30	78.0	11.0	22	6.5	3.2	69.0	84.5	1.10	0.30
234711M.SP	57	90	44	1.10	0.30	78.0	11.0	22	6.5	3.2	69.0	84.5	1.10	0.30
234412M.SP	60	95	44	1.10	0.30	83.0	11.0	22	6.5	3.2	74.0	89.5	1.10	0.30
234712M.SP	62	95	44	1.10	0.30	83.0	11.0	22	6.5	3.2	74.0	89.5	1.10	0.30
234413M.SP	65	100	44	1.10	0.30	88.0	11.0	22	6.5	3.2	79.0	94.5	1.10	0.30
234713M.SP	67	100	44	1.10	0.30	88.0	11.0	22	6.5	3.2	79.0	94.5	1.10	0.30
234414M.SP	70	110	48	1.10	0.30	97.0	12.0	24	6.5	3.2	86.5	103.5	1.10	0.30
234714M.SP	73	110	48	1.10	0.30	97.0	12.0	24	6.5	3.2	86.5	103.5	1.10	0.30

# DOUBLE DIRECTION ANGULAR CONTACT THRUST BALL BEARINGS

## 2344, 2347

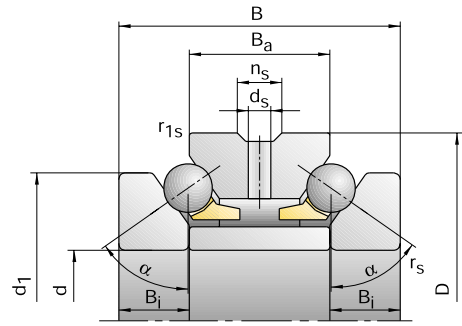

Load Ratings		Attainable Speed		Preloading Force	Unloading Force	Axial Rigidity	Weight	FAG Basic Bearing Number†
C <sub>dyn</sub>	C <sub>0stat</sub>	Grease	Oil minimal	F <sub>V</sub>	K <sub>aE</sub>	S <sub>a</sub>	kg	
kN		min <sup>-1</sup>		N		N/μm		
14.30	24.00	11000	16000	108	308	276	0.29	234406M.SP
14.30	24.00	11000	16000	108	308	276	0.27	234706M.SP
17.60	31.50	9500	14000	134	382	316	0.38	234407M.SP
17.60	31.50	9500	14000	134	382	316	0.35	234707M.SP
20.80	38.00	8500	12000	160	456	354	0.46	234408M.SP
20.80	38.00	8500	12000	160	456	354	0.43	234708M.SP
23.20	45.00	7500	10000	180	514	387	0.58	234409M.SP
23.20	45.00	7500	10000	180	514	387	0.54	234709M.SP
24.00	49.00	7000	9500	183	522	410	0.63	234410M.SP
24.00	49.00	7000	9500	183	522	410	0.58	234710M.SP
34.00	67.00	6300	8500	260	743	458	0.94	234411M.SP
34.00	67.00	6300	8500	260	743	458	0.88	234711M.SP
33.50	68.00	6000	8000	255	728	455	1.01	234412M.SP
33.50	68.00	6000	8000	255	728	455	0.94	234712M.SP
36.00	76.50	5600	7500	275	785	506	1.08	234413M.SP
36.00	76.50	5600	7500	275	785	506	1.01	234713M.SP
42.50	93.00	5300	7000	325	926	552	1.49	234414M.SP
42.50	93.00	5300	7000	325	926	552	1.36	234714M.SP

† FAG Basic Bearing Number is for reference only. All bearings are available exclusively from Barden, and must be ordered using the Barden Basic Bearing Number.

## DOUBLE DIRECTION ANGULAR CONTACT THRUST BALL BEARINGS

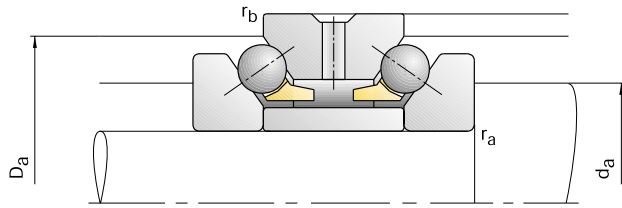

Barden Basic Bearing Number	Dimensions										Shaft & Shoulder Housing Dimensions			
	d	D	B	r <sub>smin</sub>	r <sub>1smin</sub>	d <sub>1</sub>	B <sub>i</sub>	B <sub>a</sub>	n <sub>s</sub>	d <sub>s</sub>	d <sub>a</sub> h12	D <sub>a</sub> H12	r <sub>a</sub> max	r <sub>b</sub> max
	mm													
234415M.SP	75	115	48	1.10	0.30	102.0	12.0	24	6.5	3.2	91.5	108.5	1.10	0.30
234715M.SP	78	115	48	1.10	0.30	102.0	12.0	24	6.5	3.2	91.5	108.5	1.10	0.30
234416M.SP	80	125	54	1.10	0.30	110.0	13.5	27	6.5	3.2	98.5	117.0	1.10	0.30
234716M.SP	83	125	54	1.10	0.30	110.0	13.5	27	6.5	3.2	98.5	117.0	1.10	0.30
234417M.SP	85	130	54	1.10	0.30	115.0	13.5	27	9.5	4.8	103.5	122.0	1.10	0.30
234717M.SP	88	130	54	1.10	0.30	115.0	13.5	27	9.5	4.8	103.5	122.0	1.10	0.30
234418M.SP	90	140	60	1.50	0.30	123.0	15.0	30	9.5	4.8	110.5	130.5	1.50	0.30
234718M.SP	93	140	60	1.50	0.30	123.0	15.0	30	9.5	4.8	110.5	130.5	1.50	0.30
234419M.SP	95	145	60	1.50	0.30	128.0	15.0	30	9.5	4.8	115.5	135.5	1.50	0.30
234719M.SP	98	145	60	1.50	0.30	128.0	15.0	30	9.5	4.8	115.5	135.5	1.50	0.30
234420M.SP	100	150	60	1.50	0.30	133.0	15.0	30	9.5	4.8	120.5	140.5	1.50	0.30
234720M.SP	103	150	60	1.50	0.30	133.0	15.0	30	9.5	4.8	120.5	140.5	1.50	0.30
234421M.SP	105	160	66	2.00	0.60	142.0	16.5	33	9.5	4.8	128.0	150.0	2.00	0.60
234721M.SP	109	160	66	2.00	0.60	142.0	16.5	33	9.5	4.8	128.0	150.0	2.00	0.60
234422M.SP	110	170	72	2.00	0.60	150.0	18.0	36	9.5	4.8	134.5	160.0	2.00	0.60
234722M.SP	114	170	72	2.00	0.60	150.0	18.0	36	9.5	4.8	134.5	160.0	2.00	0.60
234424M.SP	120	180	72	2.00	0.60	160.0	18.0	36	9.5	4.8	144.5	170.0	2.00	0.60
234724M.SP	124	180	72	2.00	0.60	160.0	18.0	36	9.5	4.8	144.5	170.0	2.00	0.60

# DOUBLE DIRECTION ANGULAR CONTACT THRUST BALL BEARINGS

## 2344, 2347

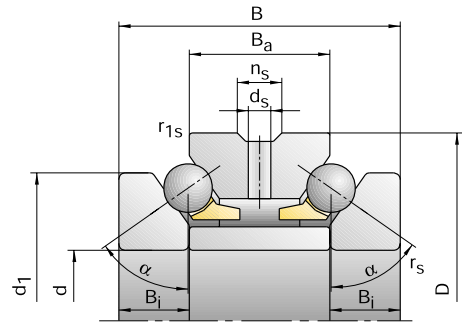

Load Ratings		Attainable Speed		Preloading Force	Unloading Force	Axial Rigidity	Weight	FAG Basic Bearing Number†
C <sub>dyn</sub>	C <sub>0stat</sub>	Grease	Oil minimal	F <sub>V</sub>	K <sub>aE</sub>	S <sub>a</sub>	kg	
kN		min <sup>-1</sup>		N		N/μm		
44.00	100.00	5000	6700	340	969	589	1.57	234415M.SP
44.00	100.00	5000	6700	340	969	589	1.43	234715M.SP
52.00	120.00	4500	6000	400	1140	640	2.16	234416M.SP
52.00	120.00	4500	6000	400	1140	640	1.98	234716M.SP
52.00	125.00	4500	6000	400	1140	655	2.25	234417M.SP
52.00	125.00	4500	6000	400	1140	655	2.07	234717M.SP
61.00	146.00	4000	5300	465	1326	708	2.92	234418M.SP
61.00	146.00	4000	5300	465	1326	708	2.71	234718M.SP
61.00	150.00	4000	5300	465	1326	724	3.04	234419M.SP
61.00	150.00	4000	5300	465	1326	724	2.83	234719M.SP
62.00	156.00	3800	5000	685	1956	843	3.17	234420M.SP
62.00	156.00	3800	5000	685	1956	843	2.95	234720M.SP
69.50	176.00	3600	4800	530	1511	775	4.07	234421M.SP
69.50	176.00	3600	4800	530	1511	775	3.73	234721M.SP
90.00	224.00	3400	4500	695	1983	853	5.19	234422M.SP
90.00	224.00	3400	4500	695	1983	853	4.79	234722M.SP
93.00	240.00	3200	4300	960	2736	996	5.56	234424M.SP
93.00	240.00	3200	4300	960	2736	996	5.14	234724M.SP

† FAG Basic Bearing Number is for reference only. All bearings are available exclusively from Barden, and must be ordered using the Barden Basic Bearing Number.



## DOUBLE DIRECTION ANGULAR CONTACT THRUST BALL BEARINGS

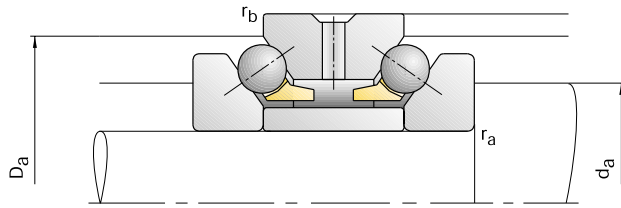

Barden Basic Bearing Number	Dimensions										Shaft & Shoulder Housing Dimensions			
	d	D	B	r <sub>smin</sub>	r <sub>1smin</sub>	d <sub>1</sub>	B <sub>i</sub>	B <sub>a</sub>	n <sub>s</sub>	d <sub>s</sub>	d <sub>a</sub> h12	D <sub>a</sub> H12	r <sub>a</sub> max	r <sub>b</sub> max
mm														
234426M.SP	130	200	84	2.00	0.60	177.0	21.0	42	12.2	6.3	159.0	188.0	2.00	0.60
234726M.SP	135	200	84	2.00	0.60	177.0	21.0	42	12.2	6.3	159.0	188.0	2.00	0.60
234428M.SP	140	210	84	2.10	0.60	187.0	21.0	42	12.2	6.3	169.0	198.0	2.10	0.60
234728M.SP	145	210	84	2.10	0.60	187.0	21.0	42	12.2	6.3	169.0	198.0	2.10	0.60
234430M.SP	150	225	90	2.10	0.60	200.0	22.5	45	15.0	8.0	181.0	211.5	2.10	0.60
234730M.SP	155	225	90	2.10	0.60	200.0	22.5	45	15.0	8.0	181.0	211.5	2.10	0.60
234432M.SP	160	240	96	2.10	0.60	212.0	24.0	48	15.0	8.0	192.5	226.0	2.10	0.60
234732M.SP	165	240	96	2.10	0.60	212.0	24.0	48	15.0	8.0	192.5	226.0	2.10	0.60
234434M.SP	170	260	108	2.10	0.60	230.0	27.0	54	15.0	8.0	206.5	245.0	2.10	0.60
234734M.SP	176	260	108	2.10	0.60	230.0	27.0	54	15.0	8.0	206.5	245.0	2.10	0.60
234436M.SP	180	280	120	2.10	0.60	248.0	30.0	60	15.0	8.0	221.0	263.0	2.10	0.60
234736M.SP	187	280	120	2.10	0.60	248.0	30.0	60	15.0	8.0	221.0	263.0	2.10	0.60
234438M.SP	190	290	120	2.10	0.60	258.0	30.0	60	15.0	8.0	231.0	273.0	2.10	0.60
234738M.SP	197	290	120	2.10	0.60	258.0	30.0	60	15.0	8.0	231.0	273.0	2.10	0.60
234440M.SP	200	310	132	2.10	0.60	274.0	33.0	66	15.0	8.0	245.0	291.5	2.10	0.60
234740M.SP	207	310	132	2.10	0.60	274.0	33.0	66	15.0	8.0	245.0	291.5	2.10	0.60
234444M.SP	220	340	144	3.00	1.10	304.0	36.0	72	17.7	9.5	269.0	318.0	3.00	1.10
234744M.SP	228	340	144	3.00	1.10	304.0	36.0	72	17.7	9.5	269.0	318.0	3.00	1.10

# DOUBLE DIRECTION ANGULAR CONTACT THRUST BALL BEARINGS

## 2344, 2347

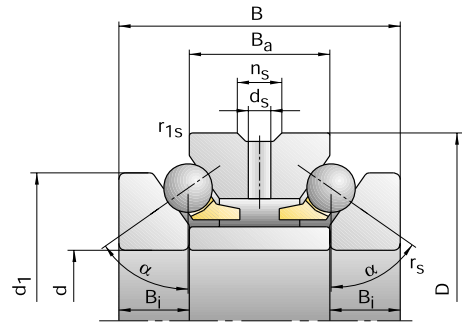

Load Ratings		Attainable Speed		Preloading Force	Unloading Force	Axial Rigidity	Weight	FAG Basic Bearing Number†
C <sub>dyn</sub>	C <sub>0stat</sub>	Grease	Oil minimal	F <sub>V</sub>	K <sub>aE</sub>	S <sub>a</sub>	kg	
kN		min <sup>-1</sup>		N		N/μm		
118.00	300.00	2800	3800	900	2570	978	8.28	234426M.SP
118.00	300.00	2800	3800	900	2570	978	7.58	234726M.SP
122.00	320.00	2600	3600	930	2649	1034	8.78	234428M.SP
122.00	320.00	2600	3600	930	2649	1034	8.07	234728M.SP
132.00	355.00	2600	3600	1320	3764	1183	10.80	234430M.SP
132.00	355.00	2600	3600	1320	3764	1183	9.95	234730M.SP
156.00	415.00	2400	3400	1180	3362	1149	12.90	234432M.SP
156.00	415.00	2400	3400	1180	3362	1149	12.00	234732M.SP
193.00	520.00	2200	3200	1847	5270	1362	17.70	234434M.SP
193.00	520.00	2200	3200	1847	5270	1362	16.30	234734M.SP
216.00	585.00	2000	3000	1660	4733	1315	23.40	234436M.SP
216.00	585.00	2000	3000	1660	4733	1315	21.50	234736M.SP
224.00	630.00	1900	2800	2110	6021	1495	24.70	234438M.SP
224.00	630.00	1900	2800	2110	6021	1495	22.60	234738M.SP
265.00	720.00	1800	2600	2000	5704	1449	31.50	234440M.SP
265.00	720.00	1800	2600	2000	5704	1449	29.20	234740M.SP
315.00	900.00	1600	2200	2400	6848	1629	41.70	234444M.SP
315.00	900.00	1600	2200	2400	6848	1629	38.50	234744M.SP

† FAG Basic Bearing Number is for reference only. All bearings are available exclusively from Barden, and must be ordered using the Barden Basic Bearing Number.



## DOUBLE DIRECTION ANGULAR CONTACT THRUST BALL BEARINGS

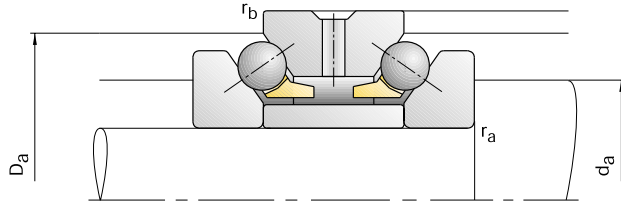

Barden Basic Bearing Number	Dimensions										Shaft & Shoulder Housing Dimensions			
	d	D	B	r <sub>smin</sub>	r <sub>1smin</sub>	d <sub>1</sub>	B <sub>i</sub>	B <sub>a</sub>	n <sub>s</sub>	d <sub>s</sub>	d <sub>a</sub> h12	D <sub>a</sub> H12	r <sub>a</sub> max	r <sub>b</sub> max
mm														
234448M.SP	240	360	144	3.00	1.10	322.0	36.0	72	17.7	9.5	289.0	338.0	3.00	1.10
234748M.SP	248	360	144	3.00	1.10	322.0	36.0	72	17.7	9.5	289.0	338.0	3.00	1.10
234452M.SP	260	400	164	4.00	1.50	354.0	41.0	82	17.7	9.5	317.5	374.5	4.00	1.50
234752M.SP	269	400	164	4.00	1.50	354.0	41.0	82	17.7	9.5	317.5	374.5	4.00	1.50
234456M.SP	280	420	164	4.00	1.50	374.0	41.0	82	17.7	9.5	337.5	394.5	4.00	1.50
234756M.SP	289	420	164	4.00	1.50	374.0	41.0	82	17.7	9.5	337.5	394.5	4.00	1.50
234460M.SP	300	460	190	4.00	1.50	406.0	47.5	95	17.7	9.5	366.0	428.5	4.00	1.50
234760M.SP	310	460	190	4.00	1.50	406.0	47.5	95	17.7	9.5	366.0	428.5	4.00	1.50
234464M.SP	320	480	190	4.00	1.50	426.0	47.5	95	17.7	9.5	386.0	448.5	4.00	1.50
234764M.SP	330	480	190	4.00	1.50	426.0	47.5	95	17.7	9.5	386.0	448.5	4.00	1.50
234468M.SP	340	520	212	4.00	1.50	459.0	53.0	106	17.7	9.5	413.0	485.5	4.00	1.50
234768M.SP	350	520	212	4.00	1.50	459.0	53.0	106	17.7	9.5	413.0	485.5	4.00	1.50
234472M.SP	360	540	212	4.00	1.50	479.0	53.0	106	17.7	9.5	433.0	505.5	4.00	1.50
234772M.SP	370	540	212	4.00	1.50	479.0	53.0	106	17.7	9.5	433.0	505.5	4.00	1.50
234476M.SP	380	560	212	4.00	1.50	499.0	53.0	106	17.7	9.5	453.0	525.5	4.00	1.50
234776M.SP	390	560	212	4.00	1.50	499.0	53.0	106	17.7	9.5	453.0	525.5	4.00	1.50
234480M.SP	400	600	236	5.00	2.00	532.0	59.0	118	17.7	9.5	480.0	561.5	5.00	2.00
234780M.SP	410	600	236	5.00	2.00	532.0	59.0	118	17.7	9.5	480.0	561.5	5.00	2.00



# DOUBLE DIRECTION ANGULAR CONTACT THRUST BALL BEARINGS

**2344, 2347**

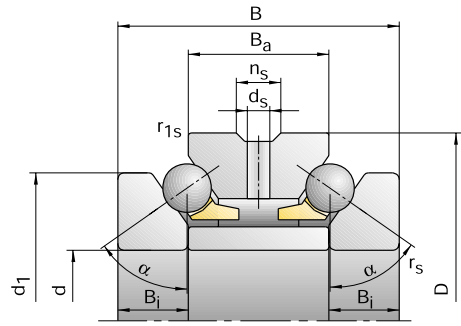

Load Ratings		Attainable Speed		Preloading Force	Unloading Force	Axial Rigidity	Weight	FAG Basic Bearing Number†
C <sub>dyn</sub>	C <sub>0stat</sub>	Grease	Oil minimal	F <sub>V</sub>	K <sub>aE</sub>	S <sub>a</sub>	kg	
kN		min <sup>-1</sup>		N		N/μm		
325.00	965.00	1500	2000	2500	7134	1729	43.80	234448M.SP
325.00	965.00	1500	2000	2500	7134	1729	40.40	234748M.SP
380.00	1180.00	1400	1900	2900	8257	1814	64.50	234452M.SP
380.00	1180.00	1400	1900	2900	8257	1814	59.70	234752M.SP
390.00	1270.00	1300	1800	3000	8542	1920	69.00	234456M.SP
390.00	1270.00	1300	1800	3000	8542	1920	63.80	234756M.SP
450.00	1530.00	1200	1700	3400	9682	2027	98.40	234460M.SP
450.00	1530.00	1200	1700	3400	9682	2027	91.20	234760M.SP
455.00	1630.00	1200	1700	3550	10109	2150	102.00	234464M.SP
455.00	1630.00	1200	1700	3550	10109	2150	94.90	234764M.SP
540.00	2000.00	1100	1600	4150	11820	2265	138.00	234468M.SP
540.00	2000.00	1100	1600	4150	11820	2265	129.00	234768M.SP
540.00	2040.00	1000	1500	4150	11820	2317	144.00	234472M.SP
540.00	2040.00	1000	1500	4150	11820	2317	135.00	234772M.SP
560.00	2200.00	1000	1500	4300	12248	2447	154.00	234476M.SP
560.00	2200.00	1000	1500	4300	12248	2447	144.00	234776M.SP
630.00	2550.00	900	1300	4900	13959	2539	198.00	234480M.SP
630.00	2550.00	900	1300	4900	13959	2539	187.00	234780M.SP

† FAG Basic Bearing Number is for reference only. All bearings are available exclusively from Barden, and must be ordered using the Barden Basic Bearing Number.





**BALL SCREW SUPPORT BEARINGS**



## BALL SCREW SUPPORT BEARINGS



Barden/FAG Series L, BSB, 7602, and 7603 ball screw support bearings are manufactured specifically for high performance ball screw applications, where extreme rigidity requirements preclude the use of standard angular contact bearings. The internal configuration has been designed to provide an optimum combination of high rigidity, low drag torque, exceptional control of axial runout, higher running speeds and longer life.

All our ball screw support bearings are nonseparable angular contact bearings and have cutaway shoulders on both the inner and outer rings. They can support very high thrust loads in one direction or combinations of radial and thrust loads, but not radial loading alone. These bearings are designed to provide machine tool drive systems with extreme axial rigidity, low drag torque and minimal axial runout. They are intended for specific

applications in machine tools, e.g., ball screw supports, cross slides, X-Y table positioners and transfer tables. They should not be used in place of standard angular contact spindle bearings.

Ball screw support bearings are available as singles, standard duplex pairs or quadruplex sets. In addition, we will supply custom combination sets to meet specialized application needs.

The limiting speeds shown on page 135 are useful guidelines. Actual speed limits must be based on the application characteristics. Life requirements, heat transfer conditions, loading and lubrication methods are typical influential factors.

Barden ball screw support bearings are manufactured with a heavy preload unless otherwise specified. Barden recognizes that some applications do not require the full axial stiffness

requirements of the standard preload and will supply bearings with custom-ground preloads if requested.

Some ball screw support bearings may also be available in sealed versions. Ask your Barden sales engineer for details.

BSB Series bearings have a molded nylon, glass fiber reinforced polyamide cage with spherical ball pockets. Inch Series, L bearings, have a land-piloted cage of reinforced phenolic, precision-machined, with evenly spaced ball pockets.

All metric (BSB, 7602, 7603 Series) ball screw support bearings come with the molded nylon cage, standard. Series L bearings are equipped with the phenolic cage, standard.

Normal fitting practice is line-to-line to loose for both shaft and housing fits.

## BARDEN BEARING NOMENCLATURE METRIC BALL SCREW SUPPORT BEARINGS

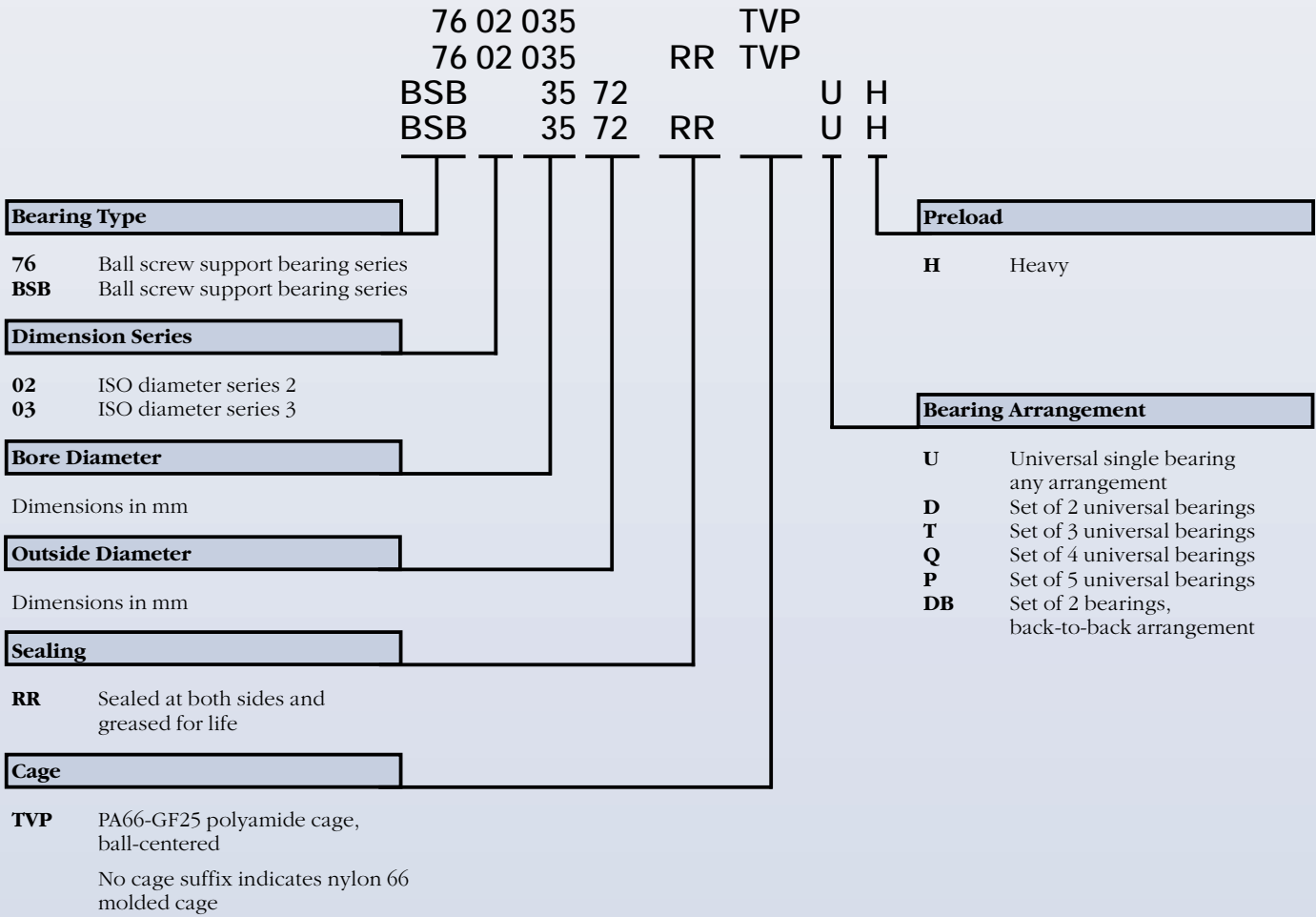

## BARDEN BEARING NOMENCLATURE INCH BALL SCREW SUPPORT BEARINGS

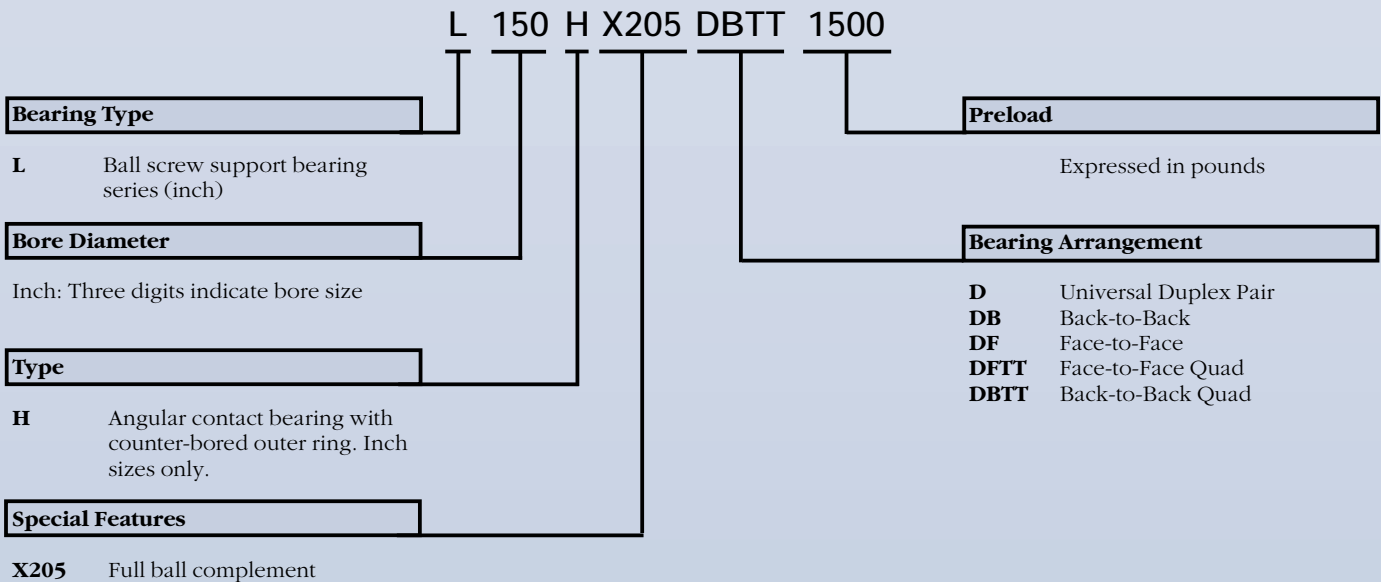

# FAG BEARING NOMENCLATURE METRIC BALL SCREW SUPPORT BEARINGS

76 02 035 .TVP  
 76 02 035 .2RS .TVP  
 BSB 035 072 .T .D .L55  
 BSB 035 072 .2RS .T

**Bearing Type**

**76** Ball screw support bearing series  
**BSB** Ball screw support bearing series

**Dimension Series**

**02** ISO diameter series 2  
**03** ISO diameter series 3

**Bore Diameter**

Dimensions in mm

**Outside Diameter**

Dimensions in mm

**Sealing**

**.2RS** Sealed at both sides  
 and greased

**Cage**

**TVP** PA66-GF25 polyamide cage,  
 ball-centered  
**T** PA66-GF25 polyamide cage,  
 ball-centered

**Grease Filling by Manufacturer**

**L55** FAG Arcanol Grease L55 is used  
 exclusively for both sealed and  
 non-sealed ball screw support  
 bearings

**Bearing Arrangement**

**D** Set of 2 universal bearings  
**T** Set of 3 universal bearings  
**Q** Set of 4 universal bearings  
**P** Set of 5 universal bearings  
**DB** Set of 2 bearings,  
 back-to-back arrangement

Bearing pairs and sets are match-marked on their outside diameter surfaces to indicate correct positioning of each bearing. Barden packaging also contains detailed instructions for proper installation.

Recommendations for shaft and housing shoulder diameters are based on maximum support of duplex-mounted bearings as found in the product tables. In circumstances with other mounting arrangements, consult Barden Product Engineering.

All designs have been optimized for grease lubrication. The sealed bearing versions are lubricated with G-73 — a high-performance Barden-recommended grease. G-73 has special EP additives that resist higher loads and periods of sliding friction. Greased open bearings can also be supplied upon request.

Most ball screw support bearing applications are subject to duty-cycle loading with constantly changing feeds, speeds and operating loads. These factors, in combination with the heavy preloads built into the bearings, make life calculations difficult. Consult Barden Product Engineering for information which can be used in specific cases.

Ball screw support bearings (rings and balls) are made from 52100 steel. Bearings are also available with X-life ultra rings and ceramic (silicon nitride) balls for even greater speeds and longer life.

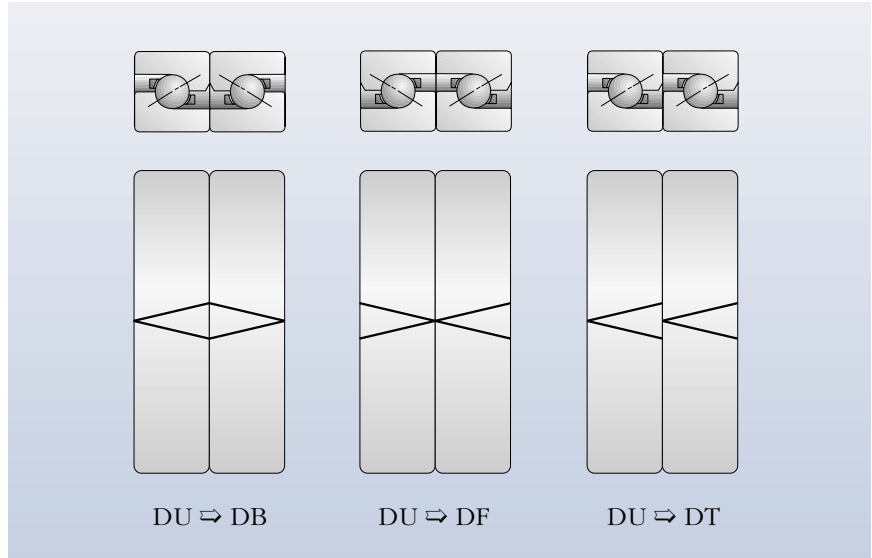

**The universal system permits the arrangement of any set desired**



**Ball screw support bearings**

## BALL SCREW SUPPORT BEARINGS

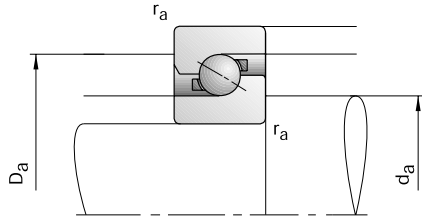

Barden Basic Bearing Number	Dimensions				Shaft & Shoulder Housing Dimensions			Load Ratings	
	d	D	B	$r_{smin}$	$d_a$ h12	$D_a$ H12	$r_a$ max	C <sub>dyn</sub> kN	C <sub>0stat</sub>
7602012TVP	12	32	10	0.6	17.0	27.0	0.6	11.60	12.50
7602015TVP	15	35	11	0.6	20.5	30.0	0.6	12.50	15.00
7602017TVP	17	40	12	0.6	23.0	34.5	0.6	16.60	20.00
7602020TVP	20	47	14	1.0	27.5	39.5	1.0	19.30	25.00
BSB2047	20	47	15	1.0	27.5	39.5	1.0	19.30	25.00
7603020TVP	20	52	15	1.1	30.5	43.5	1.1	24.50	32.00
7602025TVP	25	52	15	1.0	32.0	45.0	1.0	22.00	30.50
BSB2562	25	62	15	1.0	38.0	52.0	1.0	28.50	41.50
7603025TVP	25	62	17	1.1	38.0	52.0	1.1	28.50	41.50
BSB3062	30	62	15	1.0	39.5	52.5	1.0	26.00	39.00
7602030TVP	30	62	16	1.0	39.5	52.5	1.0	26.00	39.00
7603030TVP	30	72	19	1.1	45.0	61.0	1.1	34.50	55.00
BSB3572	35	72	15	1.0	46.5	60.5	1.1	30.00	50.00
7602035TVP	35	72	17	1.1	46.5	60.5	1.0	30.00	50.00
7603035TVP	35	80	21	1.5	51.0	67.0	1.5	36.50	61.00
BSB4072	40	72	15	1.0	49.0	62.5	1.1	28.00	49.00
7602040TVP	40	80	18	1.1	53.5	69.5	1.1	37.50	64.00
BSB4090	40	90	20	1.5	56.5	75.5	1.5	50.00	83.00
7603040TVP	40	90	23	1.5	56.5	75.5	1.5	50.00	83.00
BSB4575	45	75	15	1.0	52.0	68.0	1.0	28.50	52.00
7602045TVP	45	85	19	1.1	57.0	73.0	1.1	38.00	68.00
BSB45100	45	100	20	1.5	64.5	85.5	1.5	58.50	104.00
7603045TVP	45	100	25	1.5	64.5	85.5	1.5	58.50	104.00
7602050TVP	50	90	20	1.1	63.0	79.0	1.1	39.00	75.00
BSB50100	50	100	20	1.5	64.5	85.5	1.5	58.50	104.00
7603050TVP	50	110	27	2.0	72.0	94.0	2.0	69.50	127.00
	<b>Designation examples:</b>				<b>Standard design</b>			<b>Sealed design</b>	
	Barden				BSB2047			BSB2047RRU	
	FAG				(BSB020047T)			(BSB020047.2RS.T)	



# BALL SCREW SUPPORT BEARINGS

## BSB, 7602, 7603

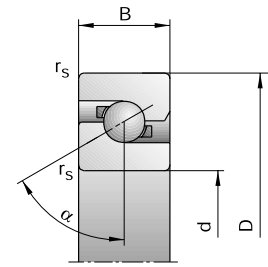

Attainable Speed Grease	Oil minimal	Preloading Force $F_V$	Unloading Force* $K_{aE}$	Axial Rigidity* $S_a$	Max. Dynamic Axial Load	Friction Torque $M_f$	Weight	FAG Basic Bearing Number†
min <sup>-1</sup>		N		N/μm	kN	Nmm	kg	
17000	24000	1375	3990	476	5.2	15	0.042	7602012TVP
15000	20000	1310	3792	516	6.3	20	0.052	7602015TVP
13000	18000	1728	5005	596	8.5	30	0.075	7602017TVP
12000	17000	2297	6645	703	10.6	50	0.12	7602020TVP
12000	17000	2297	6645	703	10.6	50	0.13	BSB020047T
11000	16000	2853	8254	787	14.0	60	0.17	7603020TVP
11000	16000	2519	7281	772	13.2	65	0.15	7602025TVP
9000	13000	3324	9611	917	18.0	85	0.24	BSB025062T
9000	13000	3324	9611	917	18.0	85	0.27	7603025TVP
9000	13000	2918	8429	893	17.0	85	0.22	BSB030062T
9000	13000	2918	8429	893	17.0	85	0.23	7602030TVP
8000	11000	4279	12378	1073	23.6	130	0.41	7603030TVP
8000	11000	3333	9623	1020	21.2	115	0.30	BSB035072T
8000	11000	3333	9623	1020	21.2	115	0.34	7602035TVP
7000	9500	4755	13760	1192	26.5	170	0.55	7603035TVP
8000	11000	2900	8361	1016	21.2	115	0.26	BSB040072T
7000	9500	4321	12483	1190	28.0	170	0.43	7602040TVP
6300	8500	5629	16273	1292	35.5	225	0.65	BSB040090T
6300	8500	5629	16273	1292	35.5	225	0.75	7603040TVP
7500	10000	3119	8996	1072	22.4	130	0.26	BSB045075T
6700	9000	4527	13080	1247	28.0	190	0.49	7602045TVP
5600	7500	6955	20065	1473	45.0	300	0.81	BSB045100T
5600	7500	6955	20065	1473	45.0	300	1.0	7603045TVP
6300	8500	4938	14271	1360	31.5	230	0.56	7602050TVP
5600	7500	6955	20065	1473	45.0	330	0.75	BSB050100T
5000	6700	7570	21820	1601	53.0	360	1.3	7603050TVP

\* value shown is for bearing pair

† FAG Basic Bearing Number is for reference only. All bearings are available exclusively from Barden, and must be ordered using the Barden Basic Bearing Number.



## BALL SCREW SUPPORT BEARINGS

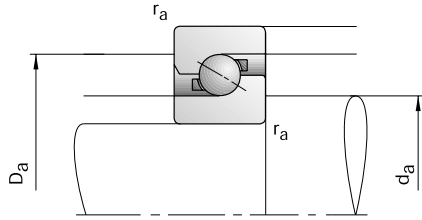

Barden Basic Bearing Number	Dimensions				Shaft & Shoulder Housing Dimensions			Load Ratings		
	d	D	B	$r_{smin}$	$d_a$ h12	$D_a$ H12	$r_a$ max	C <sub>dyn</sub>	C <sub>0stat</sub>	
	mm							kN		
BSB55090	55	90	15	1.0	65.0	80.0	1.0	32.50	65.50	
7602055TVP	55	100	21	1.5	69.5	85.5	1.5	40.50	81.50	
BSB55120	55	120	20	2.0	77.0	97.5	2.0	60.00	116.00	
7603055TVP	55	120	29	2.0	77.0	101.0	2.0	78.00	146.00	
7602060TVP	60	110	22	1.5	77.0	96.0	1.5	56.00	112.00	
BSB60120	60	120	20	1.5	79.5	100.5	1.5	61.00	120.00	
7603060TVP	60	130	31	2.1	82.5	107.5	2.1	88.00	166.00	
7602065TVP	65	120	23	1.5	84.0	103.0	1.5	57.00	122.00	
7603065TVP	65	140	33	2.1	91.5	118.5	2.1	100.00	196.00	
7602070TVP	70	125	24	1.5	87.0	108.0	1.5	65.50	137.00	
7603070TVP	70	150	35	2.1	95.5	124.5	2.1	110.00	220.00	
BSB75110	75	110	15	1.5	85.0	99.5	1.5	35.50	83.00	
7602075TVP	75	130	25	1.5	93.5	114.5	1.5	67.00	150.00	
7603075TVP	75	160	37	2.1	105.5	135.5	2.1	125.00	255.00	
7602080TVP	80	140	26	2.0	100.0	122.0	2.0	76.50	173.00	
7603080TVP	80	170	39	2.1	111.0	143.0	2.1	137.00	285.00	
7602085TVP	85	150	28	2.0	107.0	131.0	2.0	86.50	196.00	
7603085TVP	85	180	41	3.0	116.0	151.0	3.0	160.00	325.00	
7602090TVP	90	160	30	2.0	113.5	138.5	2.0	98.00	224.00	
7603090TVP	90	190	43	3.0	122.5	157.5	3.0	163.00	345.00	
7602095TVP	95	170	32	2.1	119.5	146.5	2.1	110.00	255.00	
7603095TVP	95	200	45	3.0	130.0	165.0	3.0	163.00	360.00	
BSB100150	100	150	22.5	2.0	114.5	135.0	2.0	69.50	173.00	
7602100TVP	100	180	34	2.1	125.5	154.5	2.1	122.00	285.00	
7603100TVP	100	215	47	3.0	140.0	178.0	3.0	193.00	430.00	
<b>Designation examples:</b>					<b>Standard design</b>			<b>Sealed design</b>		
Barden					BSB55090			BSB5590RR		
FAG					(BSB055090T)			BSB055090.2RS.T		

# BALL SCREW SUPPORT BEARINGS

## BSB, 7602, 7603

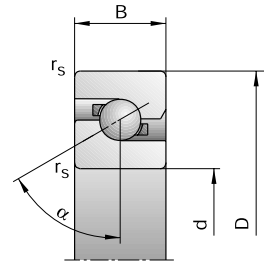

Attainable Speed Grease	Oil minimal	Preloading Force $F_V$	Unloading Force* $K_{aE}$	Axial Rigidity* $S_a$	Max. Dynamic Axial Load	Friction Torque $M_f$	Weight	FAG Basic Bearing Number†
min <sup>-1</sup>		N		N/μm	kN	Nmm	kg	
6300	8500	3625	10452	1246	28.0	190	0.38	BSB055090T
6000	8000	4561	13160	1394	33.5	250	0.75	7602055TVP
5000	6700	6777	19530	1553	50.0	360	1.2	BSB055120T
4800	6300	8791	25349	1723	63.0	460	1.7	7603055TVP
5000	6700	6493	18709	1623	47.5	350	0.94	7602060TVP
4800	6300	7085	20419	1623	53.0	380	1.1	BSB060120T
4500	6000	10031	28933	1840	75.0	540	2.1	7603060TVP
4800	6300	7012	20207	1753	50.0	410	1.2	7602065TVP
4000	5300	11937	34447	2052	90.0	700	2.6	7603065TVP
4500	6000	7021	20212	1753	56.0	440	1.3	7602070TVP
3800	5000	12271	35386	2108	95.0	760	3.2	7603070TVP
5000	6700	4462	12872	1534	33.5	290	0.47	BSB075110T
4300	5600	7561	21770	1888	63.0	480	1.4	7602075TVP
3600	4800	14436	41650	2335	118.0	920	3.8	7603075TVP
4000	5300	8941	25755	2047	75.0	600	1.7	7602080TVP
3400	4500	16138	46579	2466	132.0	1100	4.5	7603080TVP
3800	5000	10477	30195	2209	85.0	760	2.2	7602085TVP
3200	4300	17548	50625	2539	150.0	1250	5.2	7603085TVP
3600	4800	10771	31018	2275	100.0	790	2.7	7602090TVP
3000	4000	18345	52925	2654	160.0	1300	6.2	7603090TVP
3400	4500	12413	35764	2435	112.0	950	3.3	7602095TVP
3000	4000	19143	55228	2770	170.0	1450	7.2	7603095TVP
3800	5000	7481	21516	2052	71.0	600	1.4	BSB100150T
3200	4300	14164	40828	2594	125.0	1100	3.9	7602100TVP
2600	3600	21584	62216	2965	212.0	1700	8.8	7603100TVP

\* value shown is for bearing pair

† FAG Basic Bearing Number is for reference only. All bearings are available exclusively from Barden, and must be ordered using the Barden Basic Bearing Number.



## BALL SCREW SUPPORT BEARINGS

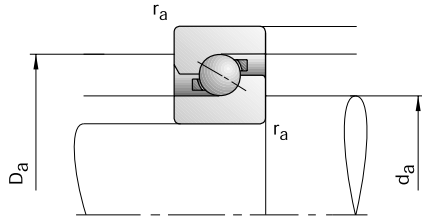

Barden Basic Bearing Number	Dimensions				Shaft & Shoulder Housing Dimensions			Load Ratings	
	d	D	B	$r_{smin}$	$d_a$ h12	$D_a$ H12	$r_a$ max	C <sub>dyn</sub>	C <sub>0stat</sub>
	mm							kN	
7602110TVP	110	200	38	2.1	139.0	171.0	2.1	146.00	355.00
7603110TVP	110	240	50	3.0	154.5	200.0	3.0	250.00	560.00
7602120TVP	120	215	40	2.1	150.0	185.0	2.1	176.00	425.00
7602130TVP	130	230	40	3.0	162.5	197.0	3.0	180.00	455.00
7603130TVP	130	280	58	3.0	181.0	229.0	3.0	290.00	695.00

## BALL SCREW SUPPORT BEARINGS, INCH SERIES (L)

Bore Diameter d		Outside Diameter D		Width B		Barden Basic Bearing Number	ATTAINABLE SPEEDS (RPM)	
mm	inch	mm	inch	mm	inch		Oil	Grease
20	.7874	47	1.8504	31.75	1.2500	L078HDF	4000	2800
23.838	.9385	62	2.4409	31.75	1.2500	L093HDF	2400	1680
38.1	1.5000	72	2.8346	31.75	1.2500	L150HDF	1600	1100
38.1	1.5000	72	2.8346	31.75	1.2500	L150HX4DF	1600	1100
44.475	1.7510	76.2	3.0000	31.75	1.2500	L175HDF	1400	1000
57.150	2.2500	90	3.5433	31.75	1.2500	L225HDF	1200	850
76.2	3.0000	110	4.3307	31.75	1.2500	L300HDF	800	600

\*\* Quadruplex widths are twice duplex widths. \*\*\* Duplex preloads. For quad set preloads multiply by 2.

# BALL SCREW SUPPORT BEARINGS

## L, BSB, 7602, 7603

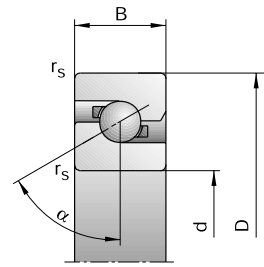

Attainable Speed Grease	Oil minimal	Preloading Force $F_v$	Unloading Force* $K_{aE}$	Axial Rigidity* $S_a$	Max. Dynamic Axial Load	Friction Torque $M_f$	Weight	FAG Basic Bearing Number†
2800	3800	16440	47385	2822	153.0	1400	5.5	7602110TVP
2400	3400	29379	84612	3363	265.0	2500	11.8	7603110TVP
2600	3600	20580	59213	3139	185.0	2000	6.5	7602120TVP
2400	3400	20650	59389	3287	200.0	2100	7.4	7602130TVP
2000	3000	33760	97158	3806	305.0	3100	18.7	7603130TVP

† FAG Basic Bearing Number is for reference only. All bearings are available exclusively from Barden, and must be ordered using the Barden Basic Bearing Number.

\* value shown is for bearing pair

Standard Preloads (lbs.)***	Shaft and Housing Shoulder Diameters (in.) ±.005"		Fitting Practice (in.) (Line-to-Line to Loose)		Axial Spring Constant (×10 <sup>6</sup> lbs./in.) Duplex	Drag Torque (in.-lbs.) Duplex	Dynamic Thrust Capacity (lbs.) Duplex	Static Thrust Capacity (lbs.) Duplex
	Shaft	Housing	Shaft	Housing				
750	1.065	1.520	.0004	.0005	5.0	2.00	3,300	4,700
1000	1.590	2.130	.0004	.0005	6.6	2.80	3,850	6,500
1500	1.880	2.430	.0004	.0005	8.4	4.00	4,000	7,500
1500	1.880	2.480	.0004	.0005	7.8	4.00	5,500	10,000
1500	2.140	2.680	.0004	.0005	9.1	4.50	4,100	8,200
1750	2.610	3.145	.0004	.0005	11.6	6.00	4,400	10,000
2250	3.385	3.915	.0005	.0007	14.3	8.00	4,850	12,900



110  
130



## AXIAL-RADIAL CYLINDRICAL ROLLER BEARINGS

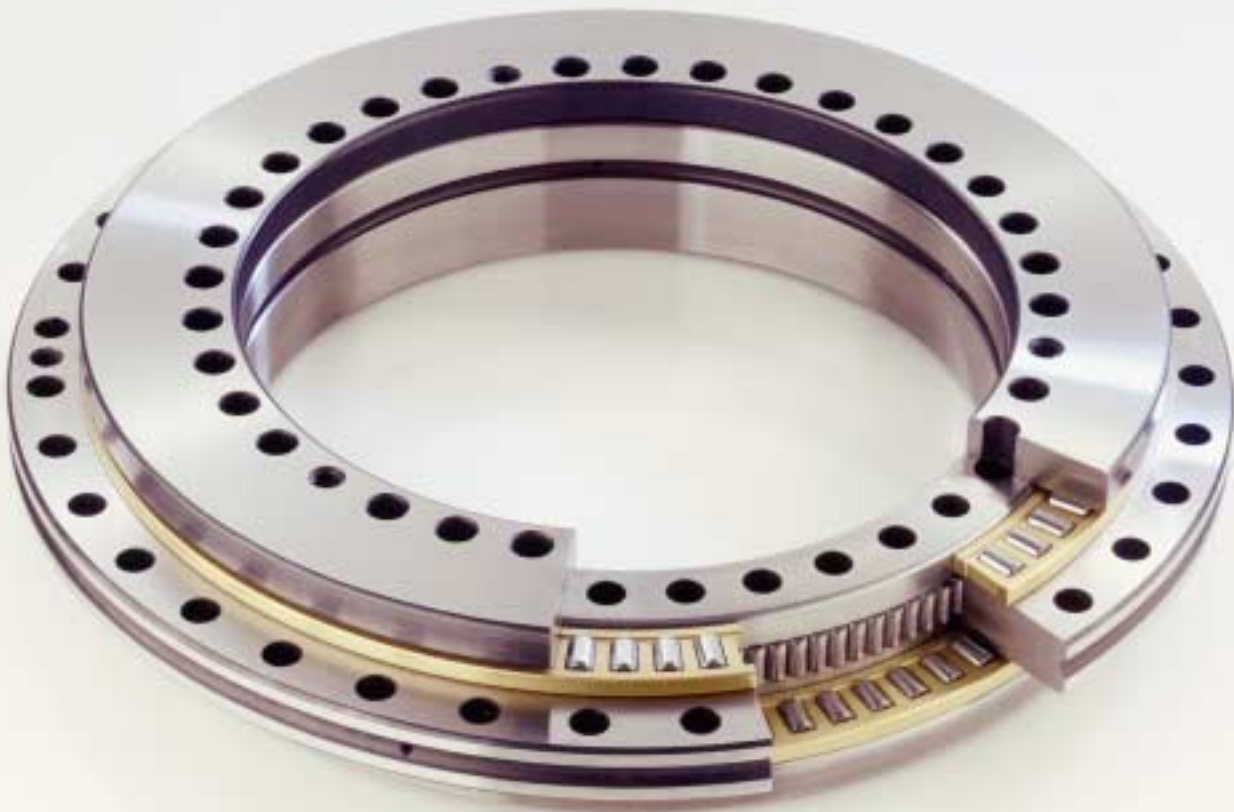

## AXIAL-RADIAL CYLINDRICAL ROLLER BEARINGS



FAG axial-radial cylindrical roller bearings — called RTC bearings — are designed for use in rotary tables, face plates and other high-precision bearing applications. Axial-radial cylindrical roller bearings meet or exceed P4 tolerance requirements.

RTC bearings utilize the same technology found in FAG super precision cylindrical roller bearings. They are fitted with precision cages,

and feature ring raceways that have a very high surface quality.

High internal accuracy is also a determining factor in providing even load distribution and high rigidity. The super-precision nature of the RTC design results in a bearing offering significantly improved speedability without any loss of rigidity. RTC bearings can easily handle the high-speed

requirements of today's demanding turn table applications.

RTC bearings are easy to install. Fastening holes at the inner and outer rings enable a reliable and rigid connection with the surrounding structure. Through-holes on the inner rings facilitate mounting on a shaft.



# BARDEN/FAG BEARING NOMENCLATURE AXIAL-RADIAL CYLINDRICAL ROLLER BEARINGS

RTC 260

**Bearing Type**

RTC Axial-radial cylindrical roller bearing

**Bore Diameter**

Dimensions in mm





**Super precision components ensure the enhanced performance of RTC bearings**

All axial-radial cylindrical roller bearings are factory lubricated with G-73, a Barden-recommended high performance grease noteworthy for its high load carrying capacity. This fact, in conjunction with the high-grade surfaces, results in a durable precision bearing with long service life.

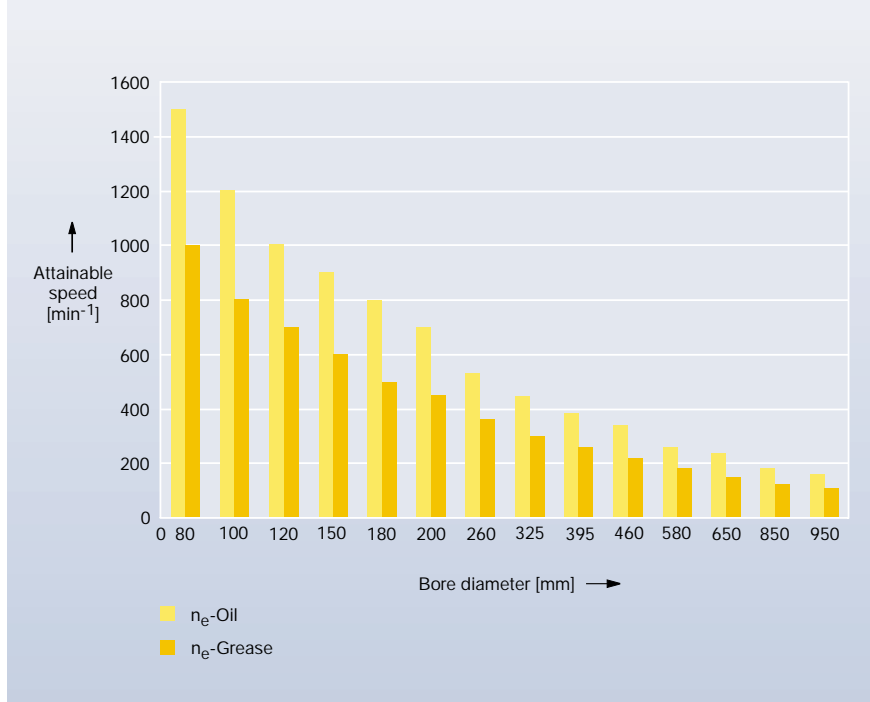

**Higher speeds attainable for RTC bearings**

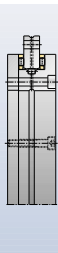

## AXIAL-RADIAL CYLINDRICAL ROLLER BEARINGS

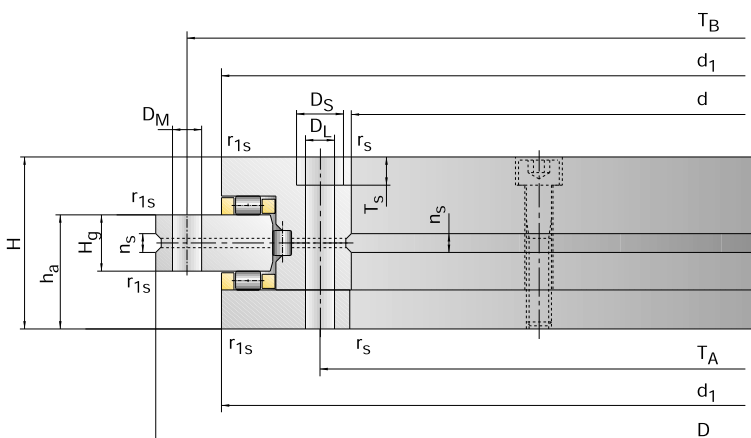

Barden Basic Bearing Number	Dimensions								
	d	D	H	$h_a$	$H_g$	$d_1$	$n_s$	$r_a$ $r_{smin}$	$r_b$ $r_{1smin}$
	mm								
RTC080	80	146	35	23.35	12	130	2.7	0.3	0.3
RTC100	100	185	38	25.0	12	160	4	0.3	0.6
RTC120	120	210	40	26.0	12	184	4	0.3	0.6
RTC150	150	240	40	26.0	12	212	4	0.3	0.6
RTC180	180	280	43	29.0	15	242	4	0.3	0.6
RTC200	200	300	45	30.0	15	272	4	0.3	0.6
RTC260	260	385	55	36.5	18	343	6	0.6	0.6
RTC325	325	450	60	40.0	20	413	6	0.6	0.6
RTC395	395	525	65	42.5	20	484	6	1.0	1.0
RTC460	460	600	70	46.0	22	558	7	1.0	1.0
RTC580	580	750	90	60.0	30	698	9	1.0	1.0
RTC650	650	870	122	78.0	34	798	10	1.0	1.0
RTC850	850	1095	124	80.5	37	1016	10	1.5	1.5
RTC950	950	1200	132	86.0	40	1128	10	1.5	1.5

# AXIAL-RADIAL CYLINDRICAL ROLLER BEARINGS

## RTC

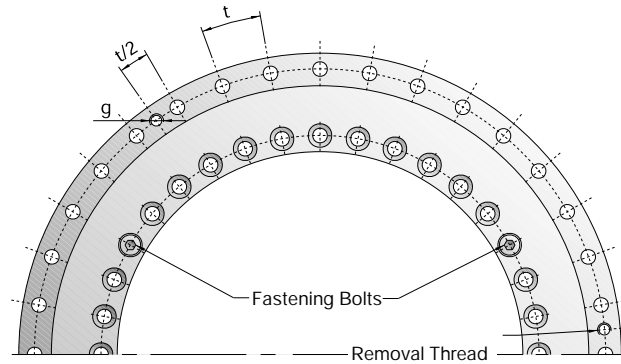

Fastening Holes Inner Ring				Outer Ring							FAG Basic Bearing Number†	
TA	DL	DS	TS	Number	Fastening Bolts Number	TB	DM	Number z	Removal Thread g	Number	Pitch z x t	
92	5.6	10	5.7	12	3	138	4.6	12	–	–	12 x 30°	RTC080
112	5.6	10	5.7	15	3	170	5.6	18	M5	3	18 x 20°	RTC100
135	7.0	11	7.0	21	3	195	7.0	24	M6	3	24 x 15°	RTC120
165	7.0	11	7.0	33	3	225	7.0	36	M6	3	36 x 10°	RTC150
194	7.0	11	7.0	45	3	260	7.0	48	M6	3	48 x 7.5°	RTC180
215	7.0	11	7.0	45	3	285	7.0	48	M6	3	48 x 7.5°	RTC200
280	9.3	15	9.3	33	3	365	9.3	36	M8	3	36 x 10°	RTC260
342	9.3	15	9.3	33	3	430	9.3	36	M8	3	36 x 10°	RTC325
415	9.3	15	9.3	45	3	505	9.3	48	M8	3	48 x 7.5°	RTC395
482	9.3	15	9.3	45	3	580	9.3	48	M8	3	48 x 7.5°	RTC460
610	11.4	18	11.0	42	6	720	11.4	48	M10	6	48 x 7.5°	RTC580
680	14.0	20	13.0	42	6	830	14.0	48	M12	6	48 x 7.5°	RTC650
890	18.0	26	17.5	54	6	1055	18.0	60	M16	6	60 x 6°	RTC850
990	18.0	26	17.5	54	6	1160	18.0	60	M16	6	60 x 6°	RTC950

† FAG Basic Bearing Number is for reference only. All bearings are available exclusively from Barden, and must be ordered using the Barden Basic Bearing Number.



## AXIAL-RADIAL CYLINDRICAL ROLLER BEARINGS

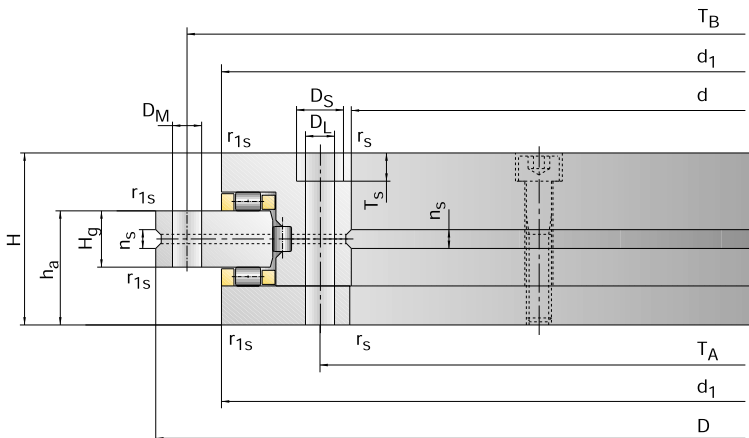

Barden Basic Bearing Number	Load Ratings				Attainable Speed*		Axial Preload	Axial Unloading Force	Axial Rigidity	mounted
	C <sub>dyn.</sub> axial kN	C <sub>0stat.</sub>	C <sub>dyn.</sub> radial	C <sub>0stat.</sub>	Grease min <sup>-1</sup>	Oil minimal	F <sub>V</sub> kN	K <sub>aE</sub>	S <sub>a</sub> kN/μm	S <sub>a1</sub>
RTC080	56	255	42.5	100	1000	1500	20.7	44	8.8	1.4
RTC100	76.5	415	47.5	120	800	1200	60.4	128	14.2	2.4
RTC120	102	540	52	143	700	1000	71.9	152	15.2	2.6
RTC150	112	630	56	170	600	900	84.6	179	17.9	3.0
RTC180	118	710	69.5	200	500	800	95.2	201	20.1	3.4
RTC200	120	765	81.5	220	450	700	102	215	21.5	3.6
RTC260	160	1060	93	290	360	530	117	248	24.8	4.1
RTC325	275	1930	120	345	300	450	162	342	34.2	5.7
RTC395	300	2280	186	655	260	380	214	452	41.1	6.9
RTC460	355	2800	200	765	220	340	243	515	46.8	7.8
RTC580	490	4250	228	965	180	260	385	815	62.7	10.5
RTC650	1040	8000	490	1800	150	240	447	946	67.6	11.2
RTC850	1000	8650	455	1730	120	180	571	1208	80.5	13.4
RTC950	1290	11400	530	2040	110	160	639	1352	90.1	15.1

# AXIAL-RADIAL CYLINDRICAL ROLLER BEARINGS

## RTC

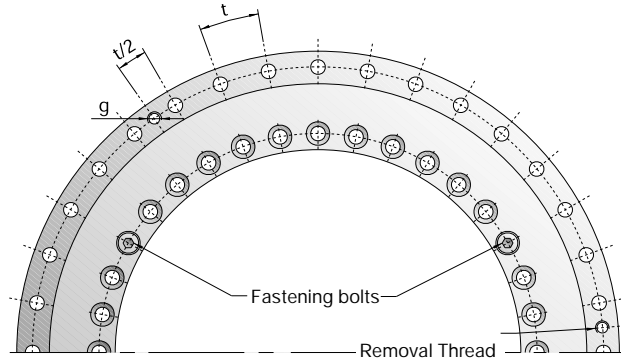

Radial Rigidity $S_r$ max.	Tilting Rigidity		Friction Torque $M_r$ Nm	Fastening Bolts Thread Nominal Diameter	Tightening Torque Bolt Quality			Weight kg	FAG Basic Bearing Number†
	$S_k$ kNm/mrad	$S_{k1}$			8.8	10.9	12.9		
3.0	10	1.6	1	M5	6	8.5	10	2.0	RTC080
4.5	37	6	4	M5	6	8.5	10	4.0	RTC100
6.0	65	11	5	M6	10	14	17	5.0	RTC120
7.5	83	14	7	M6	10	14	17	5.8	RTC150
7.5	125	21	9	M6	10	14	17	8.0	RTC180
6.5	160	27	11	M6	10	14	17	9.3	RTC200
8.5	320	53	16	M8	25	34	40	18	RTC260
8.0	630	105	27	M8	25	34	40	25	RTC325
14.0	1100	185	42	M8	25	34	40	33	RTC395
16.5	1700	285	55	M8	25	34	40	48	RTC460
20.0	3400	570	133	M10	50	70	85	84	RTC580
22.0	5000	830	183	M12	85	120	140	169	RTC650
20.0	9600	1600	295	M16	200	290	350	236	RTC850
22.0	12500	2100	366	M16	200	290	350	270	RTC950

† FAG Basic Bearing Number is for reference only. All bearings are available exclusively from Barden, and must be ordered using the Barden Basic Bearing Number.



# ENGINEERING

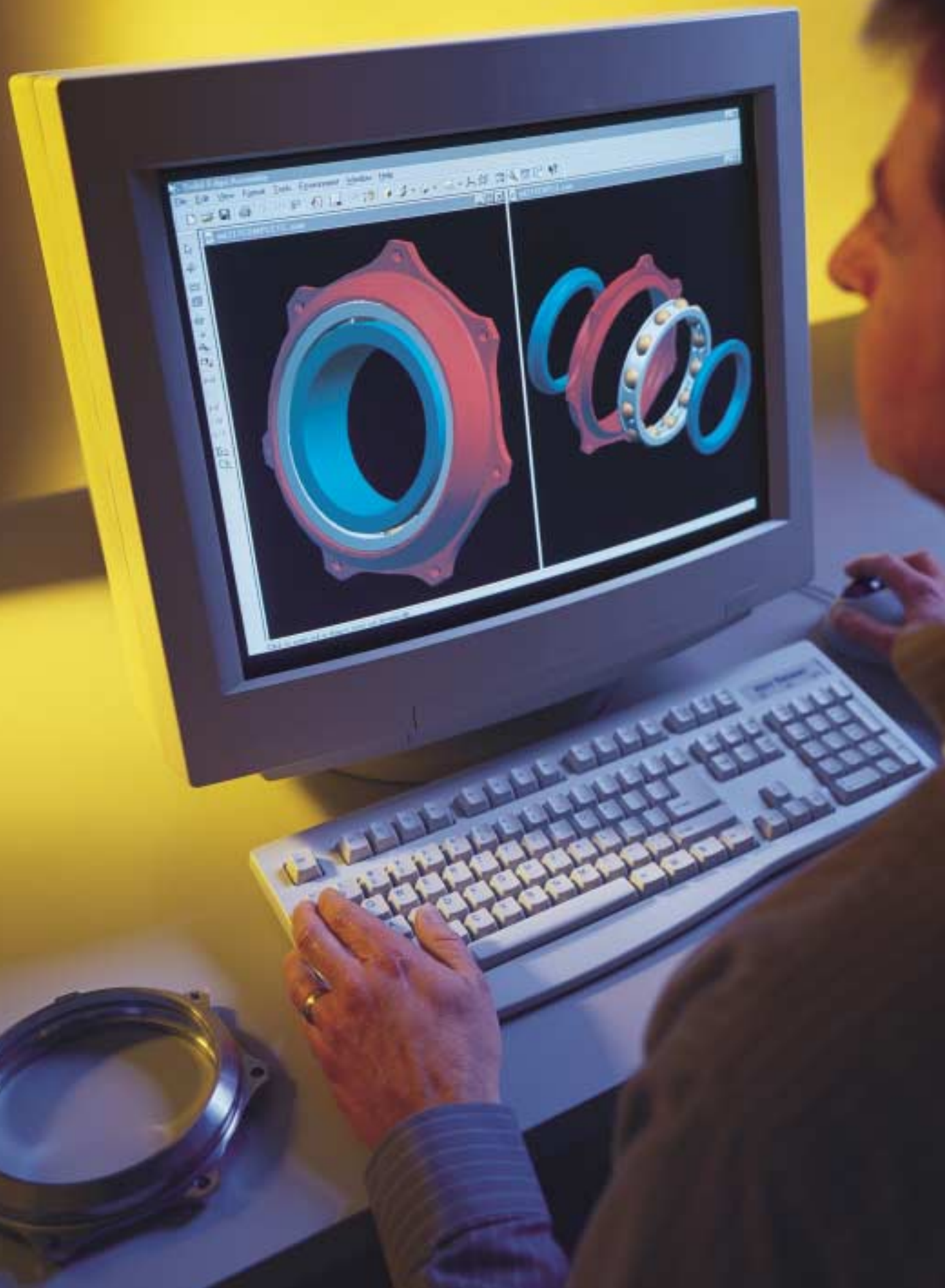



# ENGINEERING

## Table of Contents

Assembly . . . . .	196	Lubrication . . . . .	156-167	Shaft and housing fits, by product	
Calibration . . . . .	196	Cleanliness . . . . .	158	Axial-radial cylindrical roller	
Clearance adjustment in cylindrical		Contamination factor V . . . . .	159	bearings, RTC . . . . .	182, 189
roller bearings . . . . .	198	Practices . . . . .	162	Ball screw support bearings . . . . .	188
Documentation . . . . .	198	Rated viscosity . . . . .	156	Cylindrical roller bearings . . . . .	185-186
Handling super precision bearings . . . . .	196	Viscosity . . . . .	161	Double direction angular contact	
Lubricating greases . . . . .	161-163, 196	<i>(also see grease and oil lubrication)</i>		thrust ball bearings . . . . .	187
Mounting . . . . .	196	Machining tolerances for		Spindle bearings . . . . .	183
Preloading clamping forces . . . . .	197	mating parts . . . . .	180-189	Speed-dependent fits . . . . .	190-191
Preparation of parts . . . . .	196	Housing . . . . .	181	Speeds . . . . .	190-193
Spindle head adjustments . . . . .	196	Inner and outer spacers . . . . .	184	<i>(also see product tables)</i>	
Test run . . . . .	198	Shaft . . . . .	180	Ball screw support bearings . . . . .	192
Calibration . . . . .	196	Shaft and housing fits		Cylindrical roller bearings . . . . .	193
Clearance adjustment in cylindrical		Axial-radial cylindrical roller		Spindle bearings . . . . .	192
roller bearings . . . . .	198	bearings . . . . .	182, 189	Spindle head adjustments . . . . .	196
Contamination, guide values for		Ball screw support bearings . . . . .	188	Static equivalent load . . . . .	154
factor V . . . . .	159	Cylindrical roller bearings . . . . .	185-186	Stress index, $f_s$ . . . . .	155
Corner dimensions . . . . .	179	Double row angular contact thrust		Temperature limits of bearing	
Deflection and rigidity		ball bearings . . . . .	187	components . . . . .	155
Axial-radial cylindrical roller		Spindle bearings . . . . .	183	Test run . . . . .	165, 198
bearings, RTC . . . . .	195	Spacer sleeves . . . . .	181	Tolerances, by geometry . . . . .	168-169
Ball screw support bearings . . . . .	195	Tapered shafts and taper angles for		Bore diameter . . . . .	168
Double direction angular contact		cylindrical roller bearings . . . . .	186	Outside diameter . . . . .	169
thrust ball bearings . . . . .	195	Minimal oil quantity lubrication . . . . .	166	Running accuracy . . . . .	169
Spindle bearings . . . . .	194	Modified life calculation . . . . .	155	Width and height . . . . .	169
Documentation . . . . .	198	Mounting . . . . .	196	Tolerances, by product . . . . .	168-178
Dynamic equivalent load . . . . .	152-153	Oil lubrication . . . . .	166-167	Axial-radial cylindrical roller	
Endurance strength . . . . .	155	Oil-air lubrication . . . . .	167	bearings . . . . .	178
Equivalent loads with varying loads		Oil-air lubrication devices . . . . .	167	Ball screw support bearings . . . . .	177
and speeds . . . . .	154	Preload clamping forces . . . . .	197	Cylindrical roller bearings . . . . .	172-174
Grease lubrication . . . . .	160-165	Preparation of parts . . . . .	196	Double direction angular contact	
Grease distribution run . . . . .	165	Radial clearance of cylindrical		thrust ball bearings . . . . .	176
Grease quantity . . . . .	162, 163	roller bearings . . . . .	175	Double row cylindrical roller	
Grease service life . . . . .	160-164	Rigidity and deflection		bearings . . . . .	173, 174
Handling super precision bearings . . . . .	196	Axial-radial cylindrical roller		Floating displacement bearings . . . . .	171
Inner and outer spacers . . . . .	184	bearings, RTC . . . . .	195	Radial clearance, cylindrical roller	
Life calculation . . . . .	152-160	Ball screw support bearings . . . . .	195	bearings . . . . .	175
		Double direction angular contact		Spindle bearings . . . . .	170
		thrust ball bearings . . . . .	195	Training . . . . .	198
		Spindle bearings . . . . .	194		

# ENGINEERING

## Life Calculation for Super Precision Bearings

Super precision bearings are designed for spindles and machinery components having high accuracy requirements while running at very high speeds with light to moderate loads. All super precision bearing types — noted for their superior accuracy, rigidity and running behavior characteristics — are specially designed for these criteria.

High-performance application demands can be met over the required life span only if no bearing wear occurs. This is dependent on the generation of a load carrying hydrodynamic lubricant film in the rolling contact area which separates the surfaces in roller contact and prevents metal-to-metal contact. With a good lubricant film, rolling bearings can achieve endurance strength in a variety of applications. The stresses occurring in the contact points as well as the bearing

kinematics are of decisive influence on bearing service life. Therefore the traditional  $L_{10}$  life calculation has proved outdated while the modified life calculation comes closer to actual field experience. For high-performance applications it is important to dimension individual bearing arrangements with the help of special calculation programs. Please consult Barden Engineering.

## Dynamic Equivalent Load P

For dynamically loaded bearings, the axial and radial loads are combined into a dynamic equivalent load P. This is the constant load derived from

- combined loads (radial and axial)
- temporarily alternating loads.

This load P is used in the life calculation (page 154) to give the same calculated life as the actual combined load.

For bearings that can accommodate both radial and axial load components, the equivalent load is calculated using the equation

$$P = X \cdot F_r + Y \cdot F_a$$

The factors X and Y are derived from the ratio of  $F_a/F_r$  compared to the bearing specific factor e (see Table 3).

## Spindle Bearings

### Contact Angle $\alpha = 15^\circ$

$$F_a/F_r \leq e$$

$$X = 1, Y = 0.$$

$$F_a/F_r > e \text{ (Tables 3 and 4)}$$

$$P = 0.44 \cdot F_r + Y \cdot F_a$$

### Contact Angle $\alpha = 25^\circ$

With bearings of  $\alpha = 25^\circ$ , the contact angle changes very little applied under axial load and therefore the axial factor Y is taken as a constant.

$$F_a/F_r \leq 0.68$$

$$P = F_r$$

$$F_a/F_r > 0.68$$

$$P = 0.41 \cdot F_r + 0.87 \cdot F_a$$

$\frac{f_0 \cdot F_a}{i \cdot C_0}$	Spindle Bearings		
	$\alpha = 15^\circ$ e	X	Y
0.3	0.4	0.44	1.4
0.5	0.43	0.44	1.31
0.9	0.45	0.44	1.23
1.6	0.48	0.44	1.16
3	0.52	0.44	1.08
6	0.56	0.44	1

i = number of bearings that accommodate the axial load

## 3: Radial and axial factors

Bore Reference Number	Factor $f_0$ Bearing Series					
	1800HC	1900HC C1900HC XC1900HC	100HC C100HC XC100HC	200HC C200HC XC200HC	ZSB1900C CZSB1900C XCZSB1900C	ZSB100C CZSB100C XCZSB100C
00	14.9	14.2	12.6	12.3	15.3	15.5
01	15.4	14.7	13.2	12.9	15.7	15.5
02	15.9	14.5	14.1	13.6	15.8	15.8
03	16.2	14.8	14.3	13.9	16	15.9
04	15.9	14.2	14.3	13.8	16.2	16.1
05	16.4	14.9	14.9	14.4	16.5	16.2
06	16.4	15.4	15.1	14.3	16.4	16.3
07	16.2	15.9	15.4	14.6	16.4	16.5
08	16	15.5	15.7	14.2	16.2	16.5
09	16.2	15.8	15.5	14.2	16.3	16.5
10	16	16	15.7	14.4	16.2	16.5
11	16.2	16	15.5	14.5	16.1	16.5
12	16.3	16.2	15.6	14.4	16.2	16.4
13	16.1	16.4	15.9	14.5	16.1	16.4
14	16	16.2	15.6	14.6	16.1	16.4
15	16	16.3	15.8	14.8	16.1	16.3
16	15.9	16.4	15.7	14.8	16.1	16.3
17	16.1	16.3	15.9	14.9	16	16.3
18	16.1	16.4	15.7	14.8	16	16.3
19	16	16.4	15.9	14.9	15.9	16.3
20	15.9	16.5	16	14.5	16	16.2
21	15.9	16.4	15.9	14.5	15.9	16.3
22	16.1	16.4	15.8	14.5	16	16.2
24	16	16.4	16	14.9	15.9	16.3
26	16.1	16.4	15.9	14.7	15.9	16.2
28	16	16.4	16	15		
30	16.1	16.3	16	15.3		
32	16	16.4	16.2	15.3		
34	16.1	16.5	15.9	15.4		
36	16	16.4	15.7	15.4		
38	16	16.4	15.9	15.2		
40	15.9	16.2	15.8	15.4		
44	15.8	16.4	15.7	15.3		
48	15.9	16.5	15.9			

4: Factor  $f_0$  for spindle bearings with a contact angle of  $\alpha = 15^\circ$

**FD Bearings and Cylindrical Roller Bearings**

For FD bearings and cylindrical roller bearings in super precision design

$$P = F_r$$

**Ball Screw Support and Double Direction Angular Contact Thrust Ball Bearings**

Angular contact thrust ball bearings are not suited for radial load  $F_r > 0.47 \cdot F_a$ . Small radial load components are not taken into consideration when calculating the equivalent load.

$$P = F_a$$

**RTC Bearings**

The layout and features of RTC bearings are directly intended for their main application as rotary table bearings in machine tools. For special applications it is advisable to determine the loads with suitable computer programs. Please contact Barden Application Engineering.

In general

$$P = F_a \quad \text{for the axial roller row}$$

$$P = F_r \quad \text{for the radial roller row}$$

# LIFE CALCULATION FOR SUPER PRECISION BEARINGS

## Equivalent Load with Varying Loads and Speeds

The equivalent load is calculated from the individual loads and speeds with their corresponding percentage of time for bearing arrangements that are subject to varying loads and speeds, according to the following equation:

$$P = \sqrt[3]{P_1^3 \cdot \frac{n_1}{n_m} \cdot \frac{q_1}{100} + P_2^3 \cdot \frac{n_2}{n_m} \cdot \frac{q_2}{100} + \dots} \text{ [kN]}$$

and the mean speed  $n_m$  from:

$$n_m = n_1 \cdot \frac{q_1}{100} + n_2 \cdot \frac{q_2}{100} + \dots \text{ [min}^{-1}\text{]}$$

## Static Equivalent Load $P_0$

The static load, i.e. loading in the absence of ring rotation, is rarely checked for super precision bearings. The stress index  $f_s$  as a measure of the static load is obtained from

$$f_s = C_0 / P_0$$

$f_s$  = static stress index

$C_0$  = static load rating [kN]

$P_0$  = static equivalent load [kN]

Factor  $f_{s^*}$  is also obtained from the following equations, substituting the dynamic loads for the static loads. It is used in the modified life calculation.

### Spindle Bearings

**Contact angle  $\alpha = 15^\circ$**

$$P_0 = F_r \text{ [kN]}$$

for  $F_a/F_r \leq 1.09$

$$P_0 = 0.5 \cdot F_r + 0.46 \cdot F_a \text{ [kN]}$$

for  $F_a/F_r > 1.09$

**Contact angle  $\alpha = 25^\circ$**

$$P_0 = F_r \text{ [kN]}$$

for  $F_a/F_r \leq 1.31$

$$P_0 = 0.5 \cdot F_r + 0.38 \cdot F_a \text{ [kN]}$$

for  $F_a/F_r > 1.31$

The load is calculated for the individual bearing for arrangements of several bearings.

An axial load is evenly distributed on the loaded bearings.

The static stress index should be higher than 3.0 in order to maintain the running accuracy of the bearings.

$f_s \geq 1$  is admissible for hybrid bearings with an extremely short-term and centric axial load (tool ejection force).

### Ball Screw Support Bearings

$$P_0 = 3.98 \cdot F_r + F_a$$

The static stress index should be higher than 2.5.

### Double Direction Angular Contact Thrust Ball Bearings

$$P_0 = F_a$$

The static stress index should be higher than 2.5.

### FD Bearings and Cylindrical Roller Bearings

$$P_0 = F_r$$

The static stress index should be higher than 3.0.

### RTC Bearings

$$P = F_a \quad \text{for the axial roller row}$$

$$P = F_r \quad \text{for the radial roller row}$$

The static stress index should be higher than 3.0.

## Modified Life Calculation $L_{hna}$

### Stress Index $f_{s^*}$

The stress index,  $f_{s^*}$ , is a measure for anticipating whether a bearing can reach endurance strength in a specific application. Individual calculations can be performed for each bearing of the load distribution and the Hertzian contact pressure in the contact zone of the bearing raceways and compared to known limits. Provided that the following conditions  $\kappa \geq 2$  and  $V = 0.3$  are met, a modified life calculation is not required.

$$f_{s^*} = C_0/P_{0^*}$$

$P_{0^*}$  can be calculated using the equations for the static equivalent load, substituting the same dynamic loads in the equivalent load equation.

Bearing Component	Temperature Limits
Cage	100 °C (212 °F)
Seal	100 °C (212 °F)
Lubricant	see chapter "Lubrication"
Bearing rings	150 °C (300 °F)

### 5: Temperature limits of bearing components

### Modified Life Calculation

Barden has developed an extended life calculation which considers the operating and environmental influences more completely than the standard life calculation. The calculated modified life does not necessarily correspond to the actual bearing service life as it may be reduced by the service life of the lubricant. In this case the life of the lubricant  $F_{10}$  (see Diagram 15) equals the bearing service life:

$$L_{hna} = a_1 \cdot a_{23} \cdot L_{h10} \text{ (modified life calculation)}$$

OR

$$F_{10} \text{ if } F_{10} < L_{hna}$$

(See Diagram 15, page 164.)

### Factor $a_1$

Bearing failures due to material fatigue are subject to statistical laws. The failure probability is taken into consideration by factor  $a_1$ .

Factor  $a_1 = 1$  corresponds to a 10-percent failure probability and is usually used for the modified life calculation.

### Factor $a_{23}$

Factor  $a_{23}$  considers the influences of material, bearing type, loading, lubrication and cleanliness. Super precision bearings are dimensionally stable up to 150 °C. The influence of temperature on the material properties need not be taken into account up to this value. Temperature limits of cage, sealing and lubricant have to be observed (see Table 5). Please consult Barden for applications of super precision bearings at higher temperatures.

To check the effects of load the stress index  $f_{s^*}$  should be ascertained. If  $f_{s^*} > 8$ , the bearing can reach endurance strength.

### Endurance Strength

Maximum Hertzian contact pressure in the rolling contact zone of the bearing raceways = 2000 MPa for 100Cr6 ball bearings and 2500 MPa for X-life ultra bearings.

# LIFE CALCULATION FOR SUPER PRECISION BEARINGS

## Bearing Type

Factor  $K_1$  (Diagram 8) considers the kinematic properties of different bearing types, curves a and b.

## Lubrication

The condition of the lubricant film is taken into account by the value  $\kappa = v/v_1$  as a measure of lubricant film thickness and  $K_2$  as a measure of the effectiveness of additives.

The rated viscosity  $v_1$  is a function of bearing size and speed and can be obtained from Diagram 6.  $v_1$  is compared to the actual existing viscosity  $v$  at operating temperature in Diagram 7. For greases the viscosity of the base oil is used.

The same  $K_2$  values can be assumed for a grease as for an oil with a suitable additive when using adequate quantities of an appropriate grease for lubrication. If the suitability of a lubricating grease is not exactly known, an  $a_{23II}$  factor from the lower limit of zone II ( $K = 6$ ) should be chosen (Diagram 9) to be on the safe side. Obtaining  $K = K_1 + K_2$  from Diagram 8 and  $\kappa$ , the  $a_{23II}$  factor is determined from Diagram 9.

$K_2$  is used in accordance with the  $f_s^*$  index for additive and non-additive lubricants whose effectiveness in rolling bearings has not been tested.

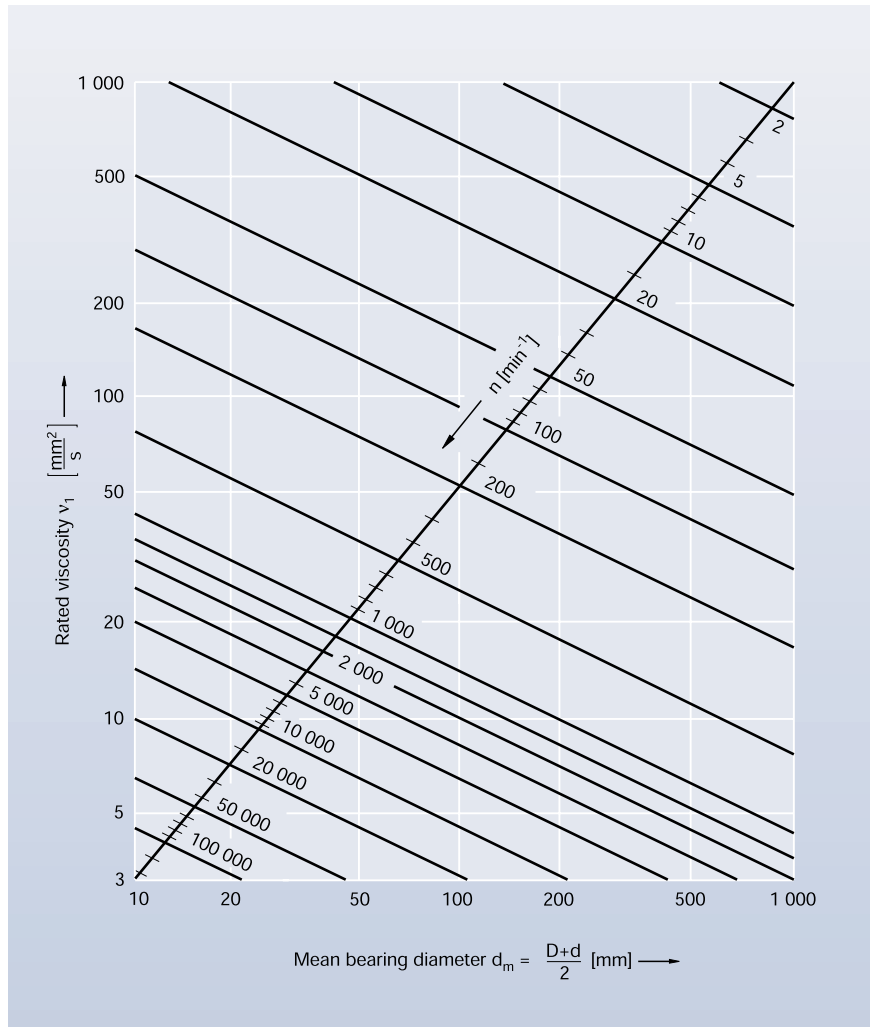

6: Rated viscosity  $v_1$

### 7: V-T diagram

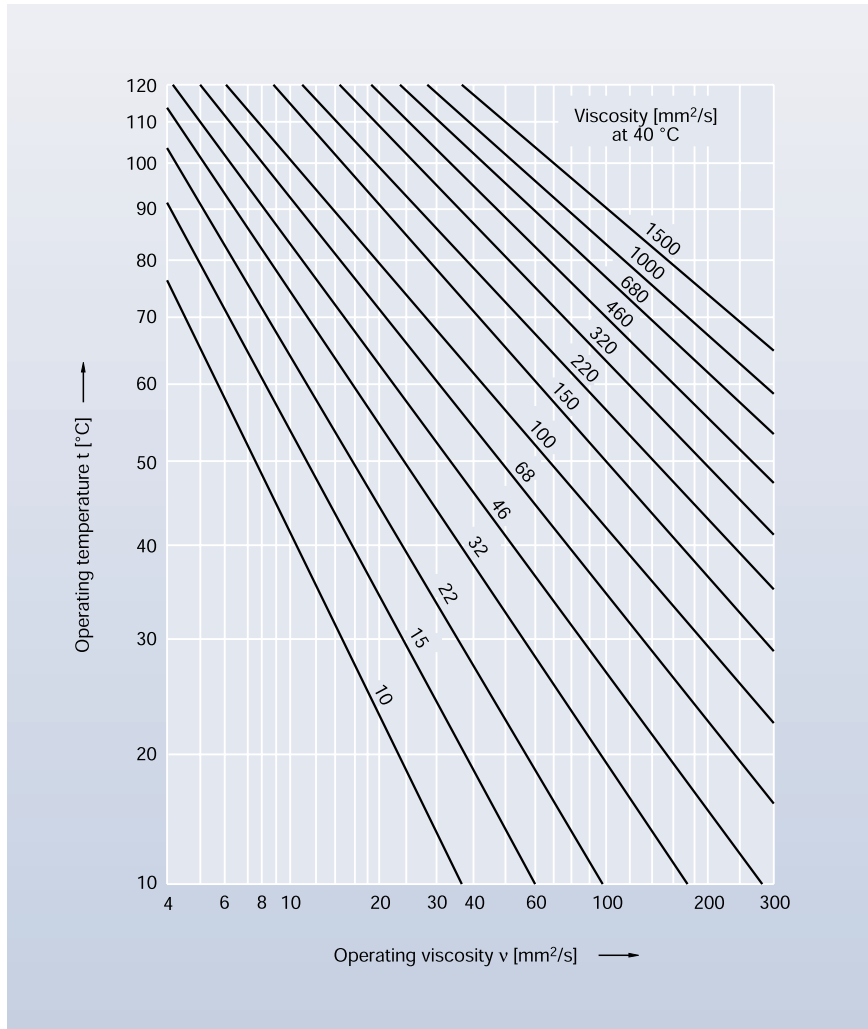

### 8: $K_1$ depending on index $f_{s^*}$ and the bearing type

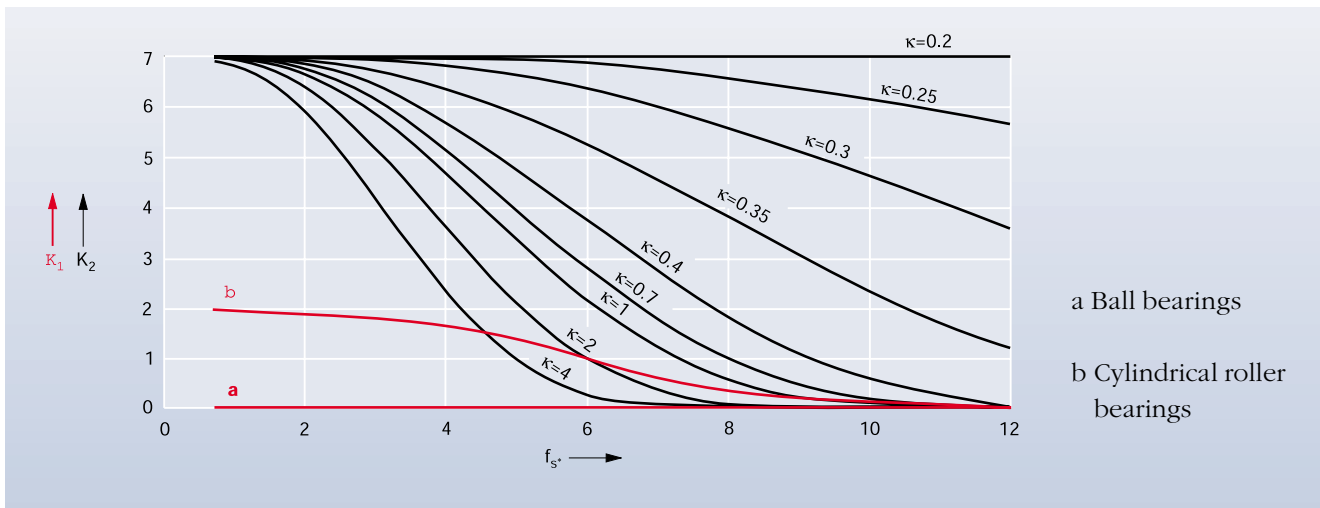

# LIFE CALCULATION FOR SUPER PRECISION BEARINGS

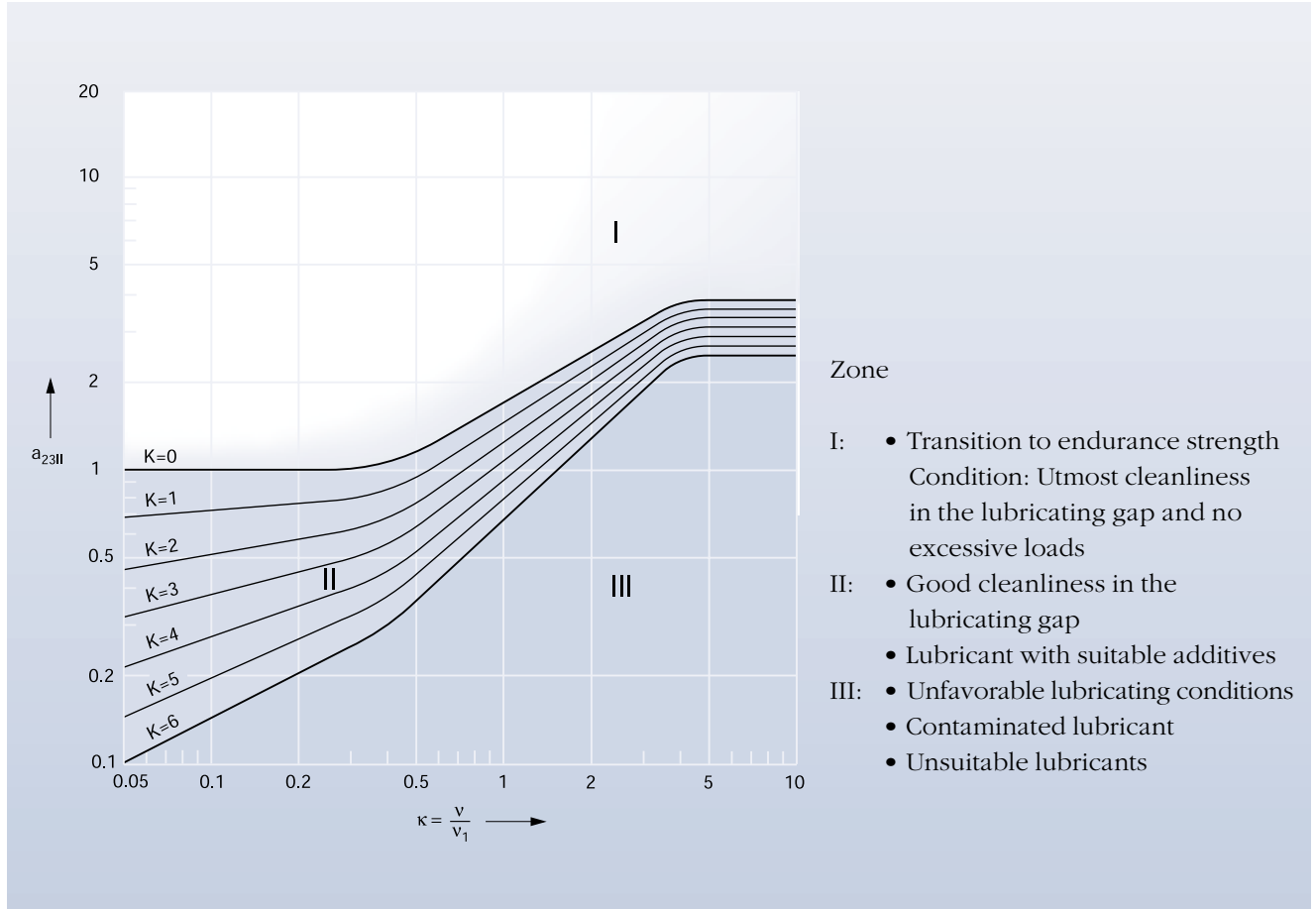

**9: Basic  $a_{23II}$  factor for determining the  $a_{23}$  factor**  
 $v$  = operating viscosity of lubricant;  $v_1$  = rated viscosity

$K_2 = 0$  for lubricants with additives for which corresponding evidence is available.

Where  $K = 0$  to  $6$ ,  $a_{23II}$  is found on one of the curves in zone II.

Where  $K > 6$ , the  $a_{23}$  factor must be expected to be in zone III.

In such a case, a smaller  $K$  value and thus zone II should be aimed at by improving operating conditions.

## Cleanliness

The cleanliness in the contact area plays a very important role for precision bearings as

- the relative influence on life is very large for lightly loaded bearings
- contamination greatly promotes wear.

It is therefore necessary to specify a cleanliness level that permits contamination less than specified

## Zone

- I: • Transition to endurance strength  
Condition: Utmost cleanliness in the lubricating gap and no excessive loads
- II: • Good cleanliness in the lubricating gap  
• Lubricant with suitable additives
- III: • Unfavorable lubricating conditions  
• Contaminated lubricant  
• Unsuitable lubricants

by factor  $V = 1$ . Reference values for the  $V$  factor have been adopted from the hydraulic field standards and can be obtained from Table 10.

The cleanliness factor  $s$  can be taken from Diagram 11. Consequently,  $a_{23}$  is derived from the equation

$$a_{23} = a_{23II} \cdot s.$$

In practice, utmost cleanliness is ensured when the bearings are greased and protected with seals,



Pitch Circle Diameter (D-d)/2 mm	V <sup>1)</sup>	Point Contact (Ball Bearings)			Line Contact (Roller Bearings)		
		required oil cleanliness class according to ISO 4406	required filtration ratio according to ISO 4572	maximum <sup>2)</sup> size of circulating particles µm	required oil cleanliness class according to ISO 4406	required filtration ratio according to ISO 4572	maximum <sup>2)</sup> size of circulating particles µm
≤ 12.5	0.3	11/8	$\beta_3 \geq 200$	10	12/9	$\beta_3 \geq 200$	20
	0.5	12/9	$\beta_3 \geq 200$		13/10	$\beta_3 \geq 75$	
	1	14/11	$\beta_6 \geq 75$	30	15/12	$\beta_6 \geq 75$	60
> 12.5 ... 20	0.3	12/9	$\beta_3 \geq 200$	15	13/10	$\beta_3 \geq 75$	25
	0.5	13/10	$\beta_3 \geq 75$		14/11	$\beta_6 \geq 75$	
	1	15/12	$\beta_6 \geq 75$	45	16/13	$\beta_{12} \geq 75$	75
> 20 ... 35	0.3	13/10	$\beta_3 \geq 75$	25	14/11	$\beta_6 \geq 75$	40
	0.5	14/11	$\beta_6 \geq 75$		15/12	$\beta_6 \geq 75$	
	1	16/13	$\beta_{12} \geq 75$	75	17/14	$\beta_{12} \geq 75$	120
> 35	0.3	14/11	$\beta_6 \geq 75$	40	14/11	$\beta_6 \geq 75$	75
	0.5	15/12	$\beta_6 \geq 75$		15/12	$\beta_{12} \geq 75$	
	1	17/14	$\beta_{12} \geq 75$	120	18/14	$\beta_{25} \geq 75$	200

The oil cleanliness class as a measure of the probability of life-reducing particles being cycled in a bearing can be determined by means of oil samples, e.g. through filter manufacturers and institutes. The cleanliness class will be reached if the total oil quantity flows through the filter within a few minutes. To safely ensure a high degree of cleanliness, flushing is required prior to bearing operation.

E.g., a filtration ratio of  $\beta_3 \geq 200$  (ISO 4572) means that only 1 out of 200 particles  $\geq 3 \mu\text{m}$  will pass the filter in a so-called multi-pass test. Filters coarser than  $\beta_{25} \geq 75$  should not be used due to the detrimental effects on the other components within the oil circulation system.

<sup>1,2)</sup> Contamination factors V apply when particles no larger than indicated of a hardness > 50 HRC are circulated in the highly loaded contact zone.

## 10: Guide values for contamination factor V

as is the case with Barden sealed spindle bearings. The life of bearings which reach endurance strength is usually limited by the service life of the lubricant (see Grease Service Life, page 164). The modified life calculation has replaced the traditional  $L_{10}$  calculation in the field of super precision

applications. The traditional  $L_{10}$  fatigue life equation is given below to enable the comparison with earlier bearing arrangements. The determination of the relevant factors has been explained in the preceding paragraphs.

$$L_{h10} = \left(\frac{C}{P}\right)^p \cdot \frac{10^6}{60 \cdot n}$$

$L_{h10}$  = Life [h] for 10% failure probability

C = Dynamic load rating [kN]

P = Dynamic equivalent load [kN]

n = Speed [ $\text{min}^{-1}$ ]

p = 3 for ball bearings

p = 10/3 for roller bearings

# LIFE CALCULATION FOR SUPER PRECISION BEARINGS

## Grease Service Life

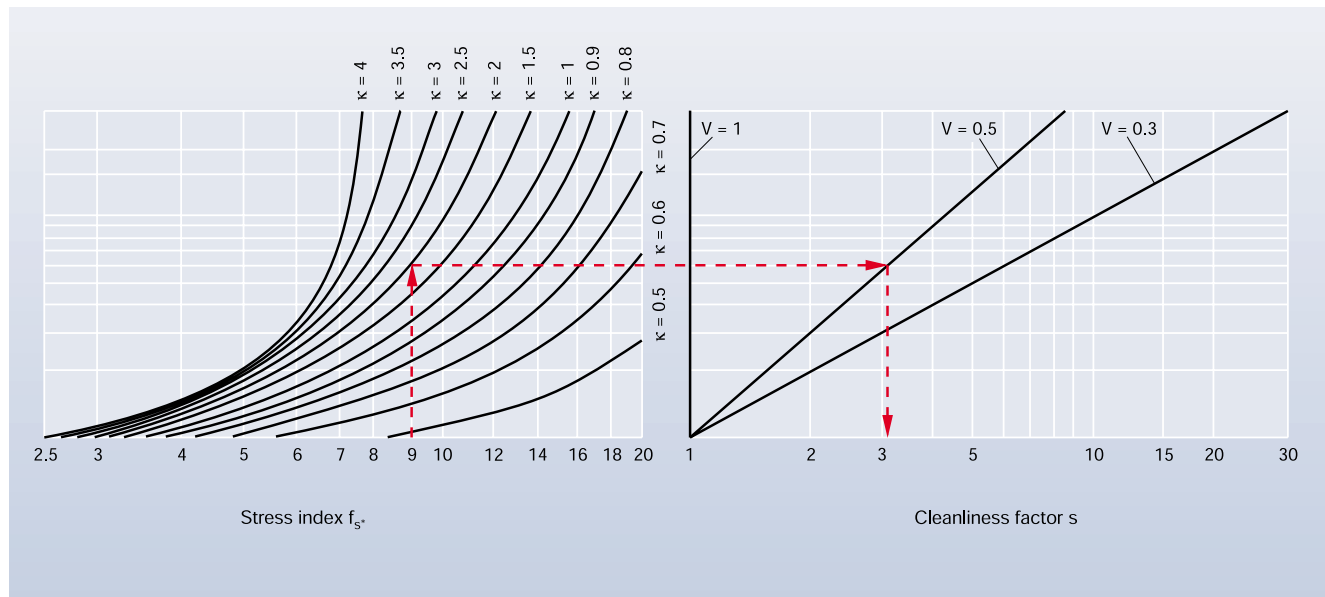

**11: Diagram for the determination of cleanliness factor  $s$**   
**Diagram for improved ( $V = 0.5$ ) to utmost ( $V = 0.3$ ) cleanliness**

The grease service life is the time during which proper bearing function is sustained by a particular quantity of grease. It depends on

- grease quantity
- grease type
- bearing type
- speed
- temperature
- installation conditions.

The grease service life is the decisive factor for the life of the bearing arrangement in comparison to the traditional  $L_{10}$  bearing fatigue life in many applications of super precision bearings. The grease life can be obtained from Diagram 15.

# LUBRICATION

## Grease Lubrication

Lubrication is a decisive factor for

- adequate bearing service life
- wear-free operation
- low vibration level.

The lubricating film separates the rolling elements from the raceway surface in the contact zone and prevents metal-to-metal contact.

In order to achieve this

- the constant presence of a lubricant at all contact points must be ensured, and
- a lubricant with appropriate properties has to be selected.

### Lubricant Viscosity

The rated viscosity of a lubricant (see Life Calculation) can be ascertained from Diagram 6. For optimum performance, the adjusted operating temperature viscosity should be at least double that of the rated viscosity.

$$\kappa = \nu / \nu_1 \geq 2$$

### Grease Lubrication

Super precision bearings are predominantly grease-lubricated. The essential advantages of grease lubrication include

- low friction
- for-life lubrication
- simplified designs
- low system costs
- reliability.

Minimum oil quantity lubrication is used when the spindle speed is too high for grease lubrication.

Development in the lubrication and bearing field has led to an enormous performance increase, specifically with respect to attainable speeds with grease lubrication. Speed indices dN of up to 1,500,000 mm/min are attainable today with grease lubrication. The use of spindle bearings supplied with initial grease filling and non-contacting seals brings further advantages, for instance utmost cleanliness as the bearing interior is protected against contamination. In addition, handling during mounting is easier. Suitable greases for super

precision bearings are listed in Table 12.

Barden grease G-75 is a high-performance grease for a wide range of high-speed spindle bearing applications up to constant temperatures of 80 °C (180 °F), measured at the outer ring. Since the temperatures in motor spindles will hardly reach 80 °C, Barden grease G-75 can be called the standard spindle bearing grease. It replaces the former Barden standard grease G-46.

Barden Grease	G-75	G-77	G-73
Designation DIN 51 502	KE3K-50	KHC3P-40	KP2N-40
Thickener	polyurea	polyurea	lithium
Base oil	PAO/ester	PAO/ester	mineral oil + ester
Base oil viscosity mm <sup>2</sup> /s at 40 °C	22	65	85
at 100 °C	5	10	12.5
Consistency class	3	3	2
Operating temperature without service life reduction (°C)	up to 80 (180 °F)	up to 100 (350 °F)	up to 70 (160 °F)
Used as	high-speed grease		high-pressure grease
Standard grease in	All open and sealed spindle bearings		BSB 7602 7603 RTC
Specific weight (approx.) g/cm <sup>3</sup>	0.92	0.88	0.9

**12: Barden bearing greases for super precision bearings**

# LUBRICATION

## Grease Lubrication

Barden G-77 is another high-speed/high-temperature grease. Thanks to its higher base oil viscosity it is used at constant temperatures between 80 °C (180 °F) and 100 °C (212 °F).

Barden lubricating grease G-73 is a high-pressure grease that is well-proven in ball screw support bearing applications, axial/radial cylindrical roller bearings (RTC) for turntables, and also in live-center tailstock bearing arrangements.

### Grease Quantity

Each bearing type requires different grease quantities. The recommendations in Tables 13 and 14 are based on the undisturbed volume of free space in the bearing.

### Lubrication Practices

Factory pre-greased bearings are highly recommended, since the correct quantity of applied lubricant can be as important as the correct type of lubricant. This is especially true of greases, where excess grease can cause high torque, overheating and — if the speed is high enough — rapid bearing failure.

Based on its lengthy experience in this field, Barden has established standard quantities of lubricants that are suitable for most applications. When grease is specified, Barden applies a predetermined amount of filtered grease to the appropriate bearing surfaces under clean-room conditions.

Bearing Code	Grease Quantity cm <sup>3</sup>	Bearing Code	Grease Quantity cm <sup>3</sup>
7602012TVP	0.42	7602060TVP	10.90
		BSB60120	8.45
7602015TVP	0.66	7603060TVP	23.40
7602017TVP	0.88	7602065TVP	13.00
		7603065TVP	28.40
7602020TVP	1.58		
BSB2047	1.84	7602070TVP	14.80
7603020TVP	1.86	7603070TVP	33.70
7602025TVP	2.15	7602075TVP	17.20
7603025TVP	3.45	BSB75110	5.45
BSB2562	2.55	7603075TVP	41.40
7602030TVP	2.95	7602080TVP	19.70
BSB3062	2.55	7603080TVP	48.90
7603030TVP	5.05		
		7602085TVP	24.70
7602035TVP	4.10	7603085TVP	55.30
BSB3572	3.10		
7603035TVP	6.60	7602090TVP	30.10
		7603090TVP	64.70
BSB4072	3.10		
7602040TVP	4.95	7602095TVP	36.20
BSB4090	6.80	7603095TVP	75.10
7603040TVP	9.20		
		7602100TVP	41.40
BSB4575	3.35	BSB100150	16.60
7602045TVP	5.95	7603100TVP	88.40
BSB45100	6.95		
7603045TVP	12.30	7602110TVP	57.90
		7603110TVP	108.00
7602050TVP	7.20		
BSB50100	6.95	7602120TVP	67.60
7603050TVP	16.00		
		7602130TVP	72.70
BSB5590	4.20		
7602055TVP	8.70		
BSB55120	8.15		
7603055TVP	19.90		

**13: Grease quantities for ball screw support bearings in cm<sup>3</sup>**

Bore/ Bore Reference Number	Grease Quantity									
	Bearing Series									
	ZSB1900	ZSB100	1900H	100H	200H	N10	N19	NN30	NNU49	2344
	CZSB1900	CZSB100	C1900H	C100H	C200H					2347
	XCZSB1900	XCZSB100	XC1900H	XC100H	XC200H					
	cm <sup>3</sup>									
6		0.12		0.04						
7		0.13		0.06						
8		0.17		0.11						
9		0.21		0.10						
00	0.17	0.26	0.09	0.17	0.26					
01	0.18	0.28	0.10	0.21	0.36					
02	0.28	0.46	0.17	0.32	0.48					
03	0.32	0.58	0.17	0.42	0.68					
04	0.58	0.98	0.36	0.76	1.12					
05	0.68	1.14	0.40	0.86	1.44					
06	0.92	1.72	0.42	1.12	2.10			1.56		3.90
07	1.18	2.20	0.64	1.74	3.00			1.78		5.00
08	1.62	2.60	1.36	2.35	3.80			2.20		6.10
09	2.10	3.65	1.60	3.00	4.55	1.34		2.90		7.80
10	2.35	4.00	1.74	3.30	5.45	1.56		3.10		8.35
11	3.40	5.95	2.20	4.60	6.50	2.20		4.45		12.20
12	3.60	6.40	2.50	4.95	8.00	2.45		4.90		12.20
13	3.90	6.80	2.65	5.30	9.35	2.55		5.10		13.30
14	5.80	9.20	4.35	7.10	10.80	3.55		7.20		17.80
15	6.10	9.70	4.60	7.50	12.90	3.90		7.80		18.90
16	7.00	12.80	4.90	9.65	12.30	5.55		10.60		25.60
17	8.55	13.40	6.80	10.30	18.30	5.55		11.10		27.80
18	9.40	17.70	7.10	13.30	19.10	7.20		14.40		38.90
19	9.85	18.40	7.45	13.90	26.10	7.20		14.40		38.90
20	12.80	19.20	9.70	14.60	27.20	7.20	5.55	14.40	5.55	44.40
21	13.30	24.60	10.10	15.00	36.30	10.00	5.55	20.00	5.55	61.10
22	14.70	28.20	10.40	21.90	43.90	13.30	5.55	26.70	5.55	61.10
24	17.90	30.30	14.20	23.60	38.80	14.40	10.00	30.00	10.00	66.70
26	24.00	43.70	18.10	36.10	41.90		11.10	36.70	11.10	105.60
28	25.60	46.30	19.30	38.30	58.60		12.20	40.00	12.20	116.70
30	37.80	57.10	28.40	44.70	81.30		21.10	50.00	21.10	138.90
32	39.90	69.70	30.00	58.20	102.90		22.20	61.10	22.20	172.20
34			31.70	65.30	120.40			83.30	23.30	227.80
36			47.40	94.90	125.70			111.10	30.00	316.70
38			50.00	99.10	155.40			116.70	33.30	311.10
40			70.60	118.30	187.80			150.00	44.40	411.10
44			68.30	172.60	250.10			200.00	52.20	522.20
48			73.70	185.30				222.20	50.00	622.20
52			118.20	267.00				311.10	94.40	833.30
56			126.00	283.90				344.40	100.00	850.00

Spindle bearings of series ZSB1900 and ZSB100 are available in pre-greased and sealed designs. Spindle bearings of the 1800H, 1900H, 100H and 200H series are also available in pre-greased and sealed versions.

**14: Recommended grease quantities in cm<sup>3</sup>**

# LUBRICATION

## Grease Lubrication

### Grease Service Life

The grease service life is the time over which proper bearing function is sustained by a particular quantity of grease. It depends on

- grease quantity
- grease type
- bearing type
- speed
- temperature
- installation, operating and environmental conditions.

In many applications of super precision bearings, the grease service life is the decisive factor for the service life of the bearing arrangement in comparison to the traditional  $L_{10}$  bearing fatigue life.

It can be determined from Diagram 15 which applies to high-speed greases. Unfavorable operating and environmental conditions, including humidity, vibration or air flow through the bearings, have to be taken into consideration with reduction factors, where applicable.

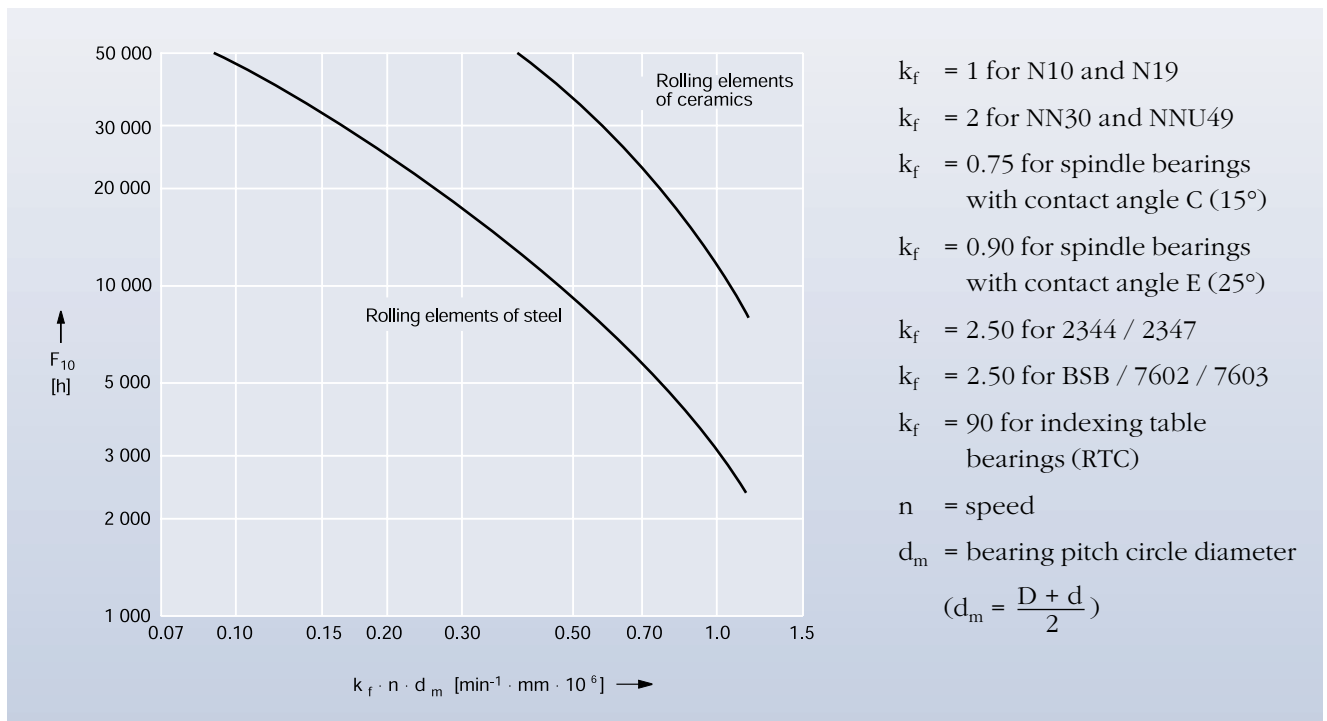

15: Grease service life  $F_{10}$

### Grease Distribution Run

The correct initial operation of grease-lubricated bearing arrangements has a significant influence on the successful performance and service life of a bearing arrangement. A start-stop running-in procedure is recommended for grease distribution. This prevents excessively high (damaging) temperatures in the contact zone between balls and raceways. During the stop phase a temperature balance takes place between the individual bearing components so

that damaging preloading conditions do not occur. It is recommended that the temperature development during the grease distribution run and the ensuing final maximum speed cycle be monitored by means of a temperature sensor located as close to the bearing outer ring as possible. A progressive rise in temperature, that occurs for instance under conditions of excessive preloading, must be avoided at all costs. The grease distribution is complete when a stable bearing temperature has been reached. The run-in procedure for

maximum speeds should be carried out at half speed initially, followed by a 0.75 fold speed prior to operation at maximum speed. Diagram 16 shows recommendations for grease distribution runs of open and sealed spindle bearings.

The grease quantity, Table 14, and the grease distribution run, Illustration 16, are available as laminated cards in small format for use in workshops.

The run-in procedure consists of several cycles of a start-stop operation with differing speeds and operating periods, the standstill periods after each run being particularly important. The required number of cycles may differ depending on bearing size, bearing number, maximum speeds and bearing environment.

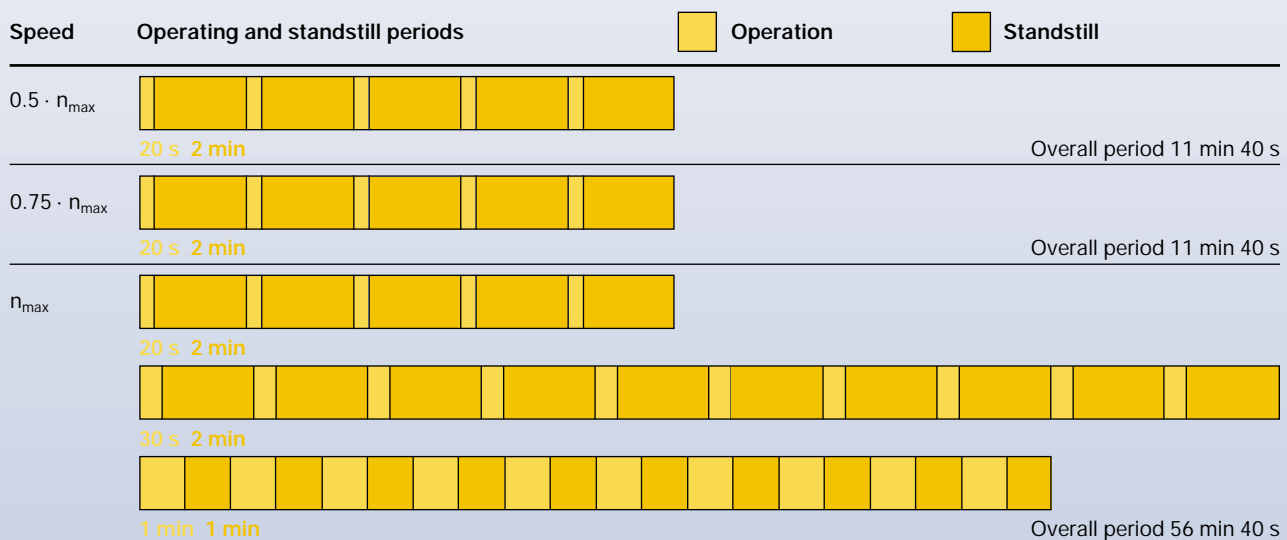

Further cycles with extended operating periods and shorter standstill periods should be carried out until a steady-state temperature has been reached.

**16: Recommendations for grease distribution runs of open and sealed spindle bearings**

# LUBRICATION

## Oil Lubrication

### Minimal Oil Quantity Lubrication

Barden spindle bearings require very little oil. An amount of approx.  $100 \text{ mm}^3/\text{h}$  is sufficient, provided that all rolling and sliding contact areas are wetted with oil. Minimal oil quantity lubrication keeps frictional losses to a minimum.

Oil lubrication is employed when the spindle speed is beyond the range of grease lubrication. The standard method today is oil-air lubrication. Speeds attainable with minimal oil quantity lubrication are listed in the dimensional tables. Oils with the designation ISO VG 68 + EP, meaning a nominal viscosity of  $68 \text{ mm}^2/\text{s}$  at  $40 \text{ }^\circ\text{C}$  and

Extreme Pressure additives, have proven suitable. Oil quantity guidelines for oil/air lubrication are shown in Diagram 17. Windage conditions in the bearing arrangement can substantially influence the required oil quantity. These starting values should be adjusted to the individual application.

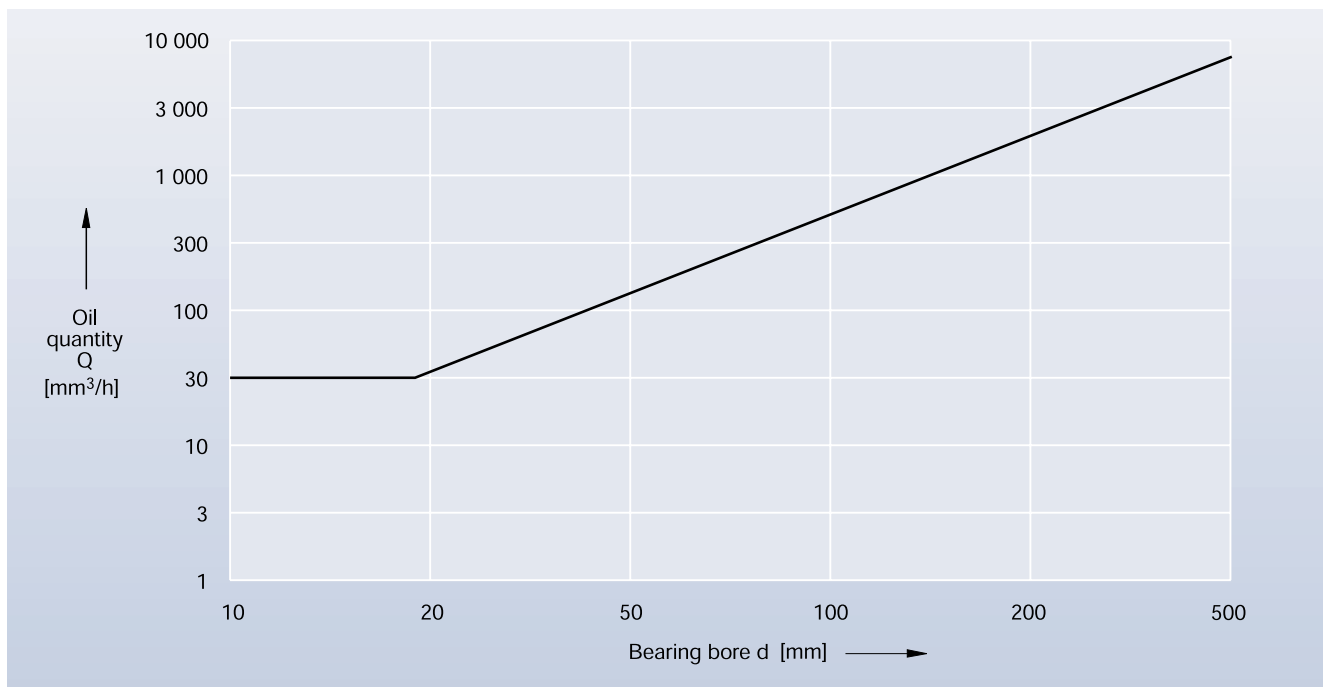

**17: Oil quantity required for oil-air lubrication of Barden spindle bearings**



## Recommendations for Oil-Air Lubrication

For standard, hybrid ceramic (C), X-life ultra (XC), and small ball (ZSB, CZSB, XCZSB) spindle bearings as well as in direct lube design (DLR):

Oil cleanliness class:	13/10 (ISO 4406)
Air cleanliness:	Particle size 0.01 $\mu\text{m}$ max.
Air dryness:	Dew point at + 2 °C
Air inlet tube pressure:	approx. 3 bars
Nozzle $\varnothing$ :	0.5 to 1 mm.
Number of nozzles:	One nozzle for each bearing, one nozzle per every 150 mm of pitch circle circumference
Nozzle design:	Inlet tube parallel to spindle rotational axis between inner ring lip and cage bore
Injection pitch circle $\varnothing$ :	See Bearing Tables ( $E_{tk}$ )
Inlet tubes:	Inner diameter 2 to 2.5 mm, flexible and transparent tubing of synthetic material; thus the oil stream at the inner tube wall is visible.
Length:	At least 1 m, optimum 4 m, up to approx. 10 m. Spirals with some five windings, center axis horizontal or up to 30° inclined, no closer than approx. 500 mm in front of the nozzle. When lubrication is interrupted, the oil will collect in the windings at the bottom and soon be available again when operation is resumed. Thus a short start up time becomes possible for spindle starts.
Oil outlets:	At both sides of each bearing; oil accumulation can cause high temperatures. For vertical spindles outlet ducts should be provided underneath each bearing so that the bearings below will not be flooded. Outlet ducts if possible $\geq \varnothing 5$ mm. Connect all outlet ducts from all bearings of one spindle together for pressure balance reasons.

### Oil-Air Lubricating Devices

Normal oil quantities per injection cycle:	3, 5, 10, 30, 60, 100 mm <sup>3</sup>
Normal injection cycles per hour:	6 to 10

Further data can be obtained from manufacturers of oil-air lubricating devices.

# TOLERANCES FOR SUPER PRECISION BEARINGS

## Tolerances for Super Precision Bearings

The tolerances for precision bearings are standardized according to ISO 492. Definitions for dimensions and accuracies are laid down in ISO 1132.

To ensure the full exploitation of the bearing performance capability and a high machining accuracy, the standard dimensional, form and running accuracies of Barden/FAG super precision bearings are manufactured to very close tolerances.

The tolerances of form and position correspond to the accuracy standard

- ABEC 9 (P2) for all super precision spindle bearings and Floating Displacement bearings (FD)
  - ABEC 7 (P4) for all for all precision cylindrical roller bearings and angular contact thrust ball bearings (BSB, 2344).
- Precision cylindrical roller bearings can be supplied in a higher precision class UP upon request.

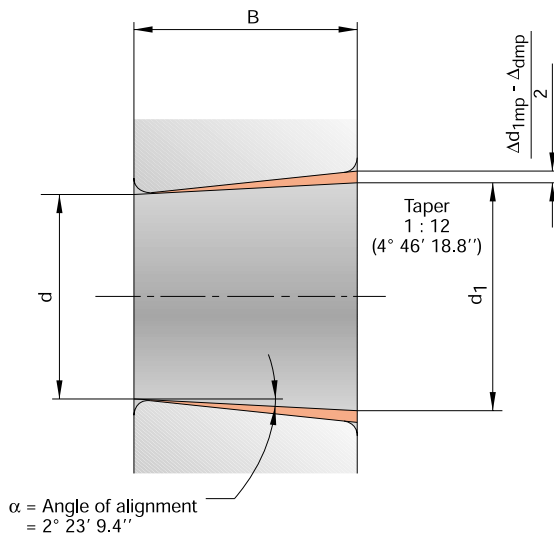

### Bore diameter

$d$  = Nominal bore diameter (tapered bore: smallest diameter)

$d_1$  = Nominal large-end diameter of tapered bores

$$\Delta d_s = d_s - d$$

Deviation of single bore diameter from nominal dimension in one radial plane

$$\Delta d_{mp} = d_{mp} - d$$

Deviation of mean bore diameter from nominal dimension in one radial plane

$$\Delta d_{1mp} = d_{1mp} - d_1$$

Deviation of mean large-end diameter of tapered bore from nominal dimension

$$V_{dp} = d_{psmax} - d_{psmin}$$

Variation of bore diameter in one radial plane

$$V_{dmp} = d_{mpmax} - d_{mpmin}$$

Variation of mean bore diameters of different radial planes

## Outside diameter

$D$  = Nominal outside diameter

$$\Delta_{Ds} = D_s - D$$

Deviation of single outside diameter from nominal dimension in one radial plane

$$\Delta_{Dmp} = D_{mp} - D$$

Deviation of mean outside diameter from nominal dimension in one radial plane

$$V_{Dp} = D_{psmax} - D_{psmin}$$

Variation of outside diameter in one radial plane

$$V_{Dmp} = D_{mpmax} - D_{mpmin}$$

Variation of mean outside diameters of different radial planes

## Width and Height

$$\Delta_{Bs}, \Delta_{Cs} = B_s - B, C_s - C$$

Deviation of single inner ring width and outer ring width from nominal dimension

$$V_{Bs}, V_{Cs} = B_{smax} - B_{smin}, C_{smax} - C_{smin}$$

Variation of inner ring width and outer ring width

$$\Delta_{Hs} = H_s - H, \Delta_{H1s} = H_{1s} - H_1, \Delta_{H2s} = H_{2s} - H_2, \dots$$

Deviation of single overall thrust bearing height from nominal dimension

$$\Delta_{has} = h_{as} - h_a,$$

Deviation of single thrust bearing height from nominal dimension

## Running accuracy

$K_{ia}$  = Radial runout of assembled bearing inner ring

$K_{ea}$  = Radial runout of assembled bearing outer ring

$S_d$  = Side face runout of inner ring with reference to bore

$S_D$  = Variation in inclination of outside cylindrical surface to outer ring side face

$S_{ia}$  = Side face runout of assembled bearing inner ring to inner ring raceway (axial runout)

$S_{ea}$  = Side face runout of assembled bearing outer ring to outer ring raceway (axial runout)

$S_i$  = Wall thickness variation of thrust bearing housing washers  
(axial runout of thrust bearings)

$S_e$  = Wall thickness variation of thrust bearing shaft washers  
(axial runout of thrust bearings)

# TOLERANCES FOR SUPER PRECISION BEARINGS

## Tolerances for Single Row Angular Contact Ball Bearings (Spindle Bearings)

Inner Ring		Dimensions in mm												
Nominal bore diameter	over	10	18	30	50	80	120	150	180	250	315	400	500	
	including	10	18	30	50	80	120	150	180	250	315	400	500	630
Tolerance Class ABEC 7 Special (P4S)		Tolerances in $\mu\text{m}$												
Bore		0	0	0	0	0	0	0	0	0	0	0	0	0
Deviation	$\Delta_{ds}, \Delta_{dmp}$	-4	-4	-5	-6	-7	-8	-10	-10	-12	-15	-19	-23	-26
Variation $V_{dp}$ (Series 1800, 1900)		2.5	2.5	3	3	4	4.5	6	6	7	9	11	14	18
Variation $V_{dp}$ (Series 100, 200)		2	2	2.5	2.5	3	3.5	5	5	6	7	9	11	14
Width deviation	$\Delta_{Bs}$	0	0	0	0	0	0	0	0	0	0	0	0	0
		-100	-100	-120	-120	-150	-200	-250	-250	-300	-350	-400	-450	-500
Width variation	$V_{Bs}$	1.5	1.5	1.5	1.5	1.5	2.5	2.5	4	5	6	7	8	10
Radial runout	$K_{ja}$	1.5	1.5	2.5	2.5	2.5	2.5	2.5	5	5	6	7	8	9
Axial runout	$S_d$	1.5	1.5	1.5	1.5	1.5	2.5	2.5	4	5	6	7	8	10
Axial runout	$S_{ja}$	1.5	1.5	2.5	2.5	2.5	2.5	2.5	5	5	7	9	11	13

Outer Ring		Dimensions in mm												
Nominal outside diameter	over	10	18	30	50	80	120	150	180	250	315	400	500	630
	including	18	30	50	80	120	150	180	250	315	400	500	630	800
Tolerance Class ABEC 7 Special (P4S)		Tolerances in $\mu\text{m}$												
Outside diameter		0	0	0	0	0	0	0	0	0	0	0	0	0
Deviation	$\Delta_{Ds}, \Delta_{Dmp}$	-4	-5	-6	-7	-8	-9	-10	-11	-13	-15	-18	-22	-26
Variation $V_{Dp}$ (Series 1800, 1900)		2.5	3	3	4	4.5	5	6	7	8	9	10	13	16
Variation $V_{Dp}$ (Series 100, 200)		2	2.5	2.5	3	3.5	4	5	5	6	7	8	10	12
Width variation	$V_{Cs}$	1.5	1.5	1.5	1.5	2.5	2.5	2.5	4	5	7	7	8	9
Radial runout	$K_{ea}$	1.5	2.5	2.5	4	5	5	5	7	7	8	9	11	13
Variation of inclination	$S_D$	1.5	1.5	1.5	1.5	2.5	2.5	2.5	4	5	7	8	9	10
Axial runout	$S_{ea}$	1.5	2.5	2.5	4	5	5	5	7	7	8	10	12	14
Width deviation $\Delta_{Cs}$ is identical with $\Delta_{Bs}$ of the corresponding inner ring.														

## Tolerances for Floating Displacement Bearings (FD)

Inner Ring		Dimensions in mm									
Nominal bore diameter	over	10	18	30	50	80	120	150	180	250	315
	including	18	30	50	80	120	150	180	250	315	400
Tolerance Class ABEC 7 Special (P4S)		Tolerances in $\mu\text{m}$									
Bore		0	0	0	0	0	0	0	0	0	0
Deviation	$\Delta_{ds}$	-4	-5	-6	-7	-8	-10	-10	-12	-15	-19
Variation $V_{dp}$ (Series 100)		2	2.5	2.5	3	3.5	5	5	6	7	9
Width deviation		0	0	0	0	0	0	0	0	0	0
	$\Delta_{Bs}$	-80	-120	-120	-150	-200	-250	-250	-300	-350	-400
Width variation	$V_{Bs}$	1.5	1.5	1.5	1.5	2.5	2.5	4	5	6	7
Radial runout	$K_{ia}$	1.5	2.5	2.5	2.5	2.5	2.5	5	5	6	7
Axial runout	$S_d$	1.5	1.5	1.5	1.5	2.5	2.5	4	5	6	7

Outer Ring		Dimensions in mm									
Nominal outside diameter	over	18	30	50	80	120	150	180	250	315	400
	including	30	50	80	120	150	180	250	315	400	500
Tolerance Class ABEC 7 Special (P4S)		Tolerances in $\mu\text{m}$									
Outside diameter		0	0	0	0	0	0	0	0	0	0
Deviation	$\Delta_{Ds}$	-5	-6	-7	-8	-9	-10	-11	-13	-15	-18
Variation $V_{Dp}$ (Series 100)		2.5	2.5	3	3.5	4	5	5	6	7	8
Width Variation	$V_{Cs}$	1.5	1.5	1.5	2.5	2.5	2.5	4	5	7	7
Radial Runout	$K_{ea}$	2.5	2.5	4	5	5	5	7	7	8	9
Variation of Inclination	$S_D$	1.5	1.5	1.5	2.5	2.5	2.5	4	5	7	8
Axial Runout	$S_{ea}$	2.5	2.5	4	5	5	5	7	7	8	10

Width deviation  $\Delta_{Cs}$  is identical with  $\Delta_{Bs}$  of the corresponding inner ring.

## TOLERANCES FOR SUPER PRECISION BEARINGS

### Tolerances for Single Row Cylindrical Roller Bearings (N10, HCN10, N19)

Inner Ring		Dimensions in mm									
Nominal bore diameter	over	18	30	50	80	120	180	250	315	400	
	including	30	50	80	120	180	250	315	400	500	
Tolerance Class SP		Tolerances in $\mu\text{m}$									
Bore, cylindrical		0	0	0	0	0	0	0	0	0	0
Deviation	$\Delta_{ds}, \Delta_{dmp}$	-6	-8	-9	-10	-13	-15	-18	-23	-27	
Variation	$V_{dp}$	3	4	5	5	7	8	9	12	14	
Bore, tapered		10	12	15	20	25	30	35	40	45	
Deviation	$\Delta_{dmp}$	0	0	0	0	0	0	0	0	0	
Variation	$V_{dp}$	3	4	5	5	7	8	9	12	14	
Deviation	$\Delta_{d1mp} - \Delta_{dmp}$	4	6	6	8	8	10	12	12	14	
Width deviation	$\Delta_{Bs}$	0	0	0	0	0	0	0	0	0	0
		-120	-120	-150	-200	-250	-300	-350	-400	-450	
Width variation	$V_{Bs}$	1.5	2	3	3	4	5	5	6	7	
Radial runout	$K_{ia}$	3	4	4	5	6	8	9	12	14	
Axial runout	$S_d$	3	3	4	4	5	6	6	7	8	
Axial runout	$S_{ia}$	8	8	8	9	10	11	15	20	23	

Outer Ring		Dimensions in mm									
Nominal outside diameter	over	30	50	80	120	150	180	250	315	400	500
	including	50	80	120	150	180	250	315	400	500	630
Tolerance Class SP		Tolerances in $\mu\text{m}$									
Outside diameter		0	0	0	0	0	0	0	0	0	0
Deviation	$\Delta_{Ds}, \Delta_{Dmp}$	-7	-9	-10	-11	-13	-15	-18	-20	-23	-28
Variation	$V_{Dp}$	4	5	5	6	7	8	9	10	12	14
Width variation	$V_{Cs}$	5	5	6	7	7	8	10	13	15	18
Radial runout	$K_{ea}$	5	5	6	7	8	10	11	13	15	17
Variation of inclination	$S_D$	8	8	9	10	10	11	13	13	15	18
Axial runout	$S_{ea}$	8	10	11	13	14	15	18	20	23	25

Width deviation  $\Delta_{Cs}$  is identical with  $\Delta_{Bs}$  of the corresponding inner ring.

## Tolerances for Double Row Cylindrical Roller Bearings (NN30, NNU49)

Inner Ring		Dimensions in mm									
Nominal bore diameter	over	18	30	50	80	120	180	250	315	400	500
	including	30	50	80	120	180	250	315	400	500	630
Tolerance Class SP		Tolerances in $\mu\text{m}$									
Bore, cylindrical		0	0	0	0	0	0	0	0	0	0
Deviation	$\Delta_{ds}, \Delta_{dmp}$	-6	-8	-9	-10	-13	-15	-18	-23	-27	-30
Variation	$V_{dp}$	3	4	5	5	7	8	9	12	14	16
Bore, tapered		10	12	15	20	25	30	35	40	45	50
Deviation	$\Delta_{dmp}$	0	0	0	0	0	0	0	0	0	0
Variation	$V_{dp}$	3	4	5	5	7	8	9	12	14	16
Deviation	$\Delta_{d1mp} - \Delta_{dmp}$	4	6	6	8	8	10	12	12	14	16
Width deviation	$\Delta_{Bs}$	0	0	0	0	0	0	0	0	0	0
		-120	-120	-150	-200	-250	-300	-350	-400	-450	-500
Width variation	$V_{Bs}$	5	5	6	7	8	10	13	15	17	20
Radial runout	$K_{ia}$	3	4	4	5	6	8	8	10	10	12
Axial runout	$S_d$	8	8	8	9	10	11	13	15	17	20
Axial runout	$S_{ia}$	8	8	8	9	10	13	15	20	23	25

Outer Ring		Dimensions in mm										
Nominal outside diameter	over	30	50	80	120	150	180	250	315	400	500	630
	including	50	80	120	150	180	250	315	400	500	630	800
Tolerance Class SP		Tolerances in $\mu\text{m}$										
Outside diameter		0	0	0	0	0	0	0	0	0	0	0
Deviation	$\Delta_{Ds}, \Delta_{Dmp}$	-7	-9	-10	-11	-13	-15	-18	-20	-23	-28	-35
Variation	$V_{Dp}$	4	5	5	6	7	8	9	10	12	14	18
Width variation	$V_{Cs}$	5	6	8	8	8	10	11	13	15	18	20
Radial runout	$K_{ea}$	5	5	6	7	8	10	11	13	15	17	20
Variation of inclination	$S_D$	8	8	9	10	10	11	13	13	15	18	20
Axial runout	$S_{ea}$	8	10	11	13	14	15	18	20	23	25	30

Width deviation  $\Delta_{Cs}$  is identical with  $\Delta_{Bs}$  of the corresponding inner ring.

# TOLERANCES FOR SUPER PRECISION BEARINGS

## Tolerances for Double Row Cylindrical Roller Bearings (NN30, NNU49)

Inner Ring		Dimensions in mm									
Nominal bore diameter	over	18	30	50	80	120	180	250	315	400	500
	including	30	50	80	120	180	250	315	400	500	630
Tolerance Class UP		Tolerances in $\mu\text{m}$									
Bore, cylindrical		0	0	0	0	0	0	0	0	0	0
Deviation	$\Delta_{ds}, \Delta_{dmp}$	-5	-6	-7	-8	-10	-12	-15	-19	-23	-26
Variation	$V_{dp}$	2.5	3	3.5	4	5	6	8	10	12	14
Bore, tapered		6	7	8	10	12	14	15	17	19	20
Deviation	$\Delta_{dmp}$	0	0	0	0	0	0	0	0	0	0
Variation	$V_{dp}$	2.5	3	3.5	4	5	6	8	10	12	14
Deviation	$\Delta_{d1mp} - \Delta_{dmp}$	2	3	3	4	4	5	6	6	7	8
		0	0	0	0	0	0	0	0	0	0
Width deviation	$\Delta_{Bs}$	0	0	0	0	0	0	0	0	0	0
		-25	-30	-40	-50	-60	-75	-100	-100	-100	-125
Width variation	$V_{Bs}$	1.5	2	3	3	4	5	5	6	7	8
Radial runout	$K_{ia}$	1.5	2	2	3	3	4	4	5	5	6
Axial runout	$S_d$	3	3	4	4	5	6	6	7	8	9
Axial runout	$S_{ia}$	3	3	3	4	6	7	8	9	10	12

Outer Ring		Dimensions in mm										
Nominal outside diameter	over	30	50	80	120	150	180	250	315	400	500	630
	including	50	80	120	150	180	250	315	400	500	630	800
Tolerance Class UP		Tolerances in $\mu\text{m}$										
Outside diameter		0	0	0	0	0	0	0	0	0	0	0
Deviation	$\Delta_{Ds}, \Delta_{Dmp}$	-5	-6	-7	-8	-9	-10	-12	-14	-17	-20	-25
Variation	$V_{Dp}$	3	3	4	4	5	5	6	7	9	10	13
Width variation	$V_{Cs}$	1	1.5	2	3	3	3.5	3.5	4	5	5.5	7.5
Radial runout	$K_{ea}$	3	3	3	4	4	5	6	7	8	9	11
Variation of inclination	$S_D$	2	2	3	3	3	4	4	5	5	6	7
Axial runout	$S_{ea}$	4	4	5	6	7	9	9	12	12	14	17

Width deviation  $\Delta_{Cs}$  is identical with  $\Delta_{Bs}$  of the corresponding inner ring.



## Radial Clearance of Cylindrical Roller Bearings (N10, HCN10, N19, NN30, NNU49)

Bearings with Cylindrical Bore		Dimensions in mm																		
		over	24	30	40	50	65	80	100	120	140	160	180	200	225	250	280	315	355	400
Nominal bore diameter	including	30	40	50	65	80	100	120	140	160	180	200	225	250	280	315	355	400	450	500
Bearing clearance in $\mu\text{m}$																				
Bearing design																				
Clearance group C1 <sup>*)</sup>	min	5	5	5	5	10	10	10	10	10	15	15	15	20	20	20	25	25	25	
	max	15	15	18	20	25	30	30	35	35	40	45	50	50	55	60	65	75	85	95
Clearance group C2	min	0	5	5	10	10	15	15	20	25	35	45	45	55	55	65	100	110	110	
	max	25	30	35	40	45	50	55	60	70	75	90	105	110	125	130	145	190	210	220

Bearings with Tapered Bore		Dimensions in mm																		
		over	24	30	40	50	65	80	100	120	140	160	180	200	225	250	280	315	355	400
Nominal bore diameter	including	30	40	50	65	80	100	120	140	160	180	200	225	250	280	315	355	400	450	500
Bearing clearance in $\mu\text{m}$																				
Bearing design																				
Clearance group C1 <sup>*)</sup>	min	15	15	17	20	25	35	40	45	50	55	60	60	65	75	80	90	100	110	120
	max	25	25	30	35	40	55	60	70	75	85	90	95	100	110	120	135	150	170	190
Clearance group C2	min	20	20	25	30	35	40	50	55	60	75	85	95	105	115	130	145	165	185	205
	max	45	45	55	60	70	75	90	100	110	125	140	155	170	185	205	225	255	285	315

<sup>\*)</sup> Bearings of tolerance classes SP and UP feature C1 radial clearance as standard; the bearing rings are not interchangeable (NA).

## TOLERANCES FOR SUPER PRECISION BEARINGS

### Tolerances for Double Direction Angular Contact Thrust Ball Bearings (Series 2344 and 2347)

Shaft Washer		Dimensions in mm									
Nominal bore diameter	over	18	30	50	80	120	150	180	250	315	400
	including	30	50	80	120	150	180	250	315	400	500
Tolerance Class SP		Tolerances in $\mu\text{m}$									
Bore		0	0	0	0	0	0	0	0	0	0
Deviation	$\Delta_{\text{dmp}}$	-8	-10	-12	-15	-18	-18	-22	-25	-30	-35
Variation	$V_{\text{dp}}$	6	8	9	11	14	14	17	19	22	26
Wall thickness variation	$S_i$	3	3	4	4	5	5	5	7	7	9
Height		50	75	100	125	150	150	175	200	250	300
variation	$\Delta_{\text{Hs}}$	-150	-200	-250	-300	-350	-350	-400	-450	-600	-750
Tolerance Class UP		Tolerances in $\mu\text{m}$									
Bore		0	0	0	0	0	0	0	0	0	0
Deviation	$\Delta_{\text{dmp}}$	-6	-8	-9	-10	-13	-13	-15	-18	-23	-27
Variation	$V_{\text{dp}}$	5	6	7	8	10	10	12	14	18	20
Wall thickness variation	$S_i$	1.5	1.5	2	2	3	3	3	4	4	5
Height		50	75	100	125	150	150	175	200	250	300
variation	$\Delta_{\text{Hs}}$	-150	-200	-250	-300	-350	-350	-400	-450	-600	-750

Housing Washer		Dimensions in mm										
Nominal outside diameter	over	30	50	80	120	150	180	250	315	400	500	630
	including	50	80	120	150	180	250	315	400	500	630	800
Tolerance Class SP		Tolerances in $\mu\text{m}$										
Outside diameter		-20	-24	-28	-33	-33	-37	-41	-46	-50	-55	-60
Deviation	$\Delta_{\text{Dmp}}$	-36	-43	-50	-58	-58	-66	-73	-82	-90	-99	-110
Variation	$V_{\text{dp}}$	5	6	8	9	9	10	12	13	15	16	18
Width deviation	$\Delta_{\text{Cs}}$	-120	-120	-125	-125	-125	-125	-150	-150	-200	-200	-250
Wall thickness variation	$S_e$	3	4	4	5	5	5	7	7	9	11	13
Tolerance Class UP		Tolerances in $\mu\text{m}$										
Outside diameter		-20	-24	-28	-33	-33	-37	-41	-46	-50	-55	-55
Deviation	$\Delta_{\text{Dmp}}$	-36	-43	-50	-58	-58	-66	-73	-82	-90	-99	-99
Variation	$V_{\text{dp}}$	5	6	8	9	9	10	12	13	15	16	18
Width deviation	$\Delta_{\text{Cs}}$	-120	-120	-125	-125	-125	-125	-150	-150	-200	-200	-250
Wall thickness variation	$S_e$	1.5	2	2	3	3	3	4	4	5	6	7

## Tolerances for Ball Screw Support Bearings (Series BSB, 7602, 7603)

Shaft Washer		Dimensions in mm									
Nominal bore diameter	over	10	18	30	50	80	120	150	180	250	315
	including	18	30	50	80	120	150	180	250	315	
Tolerance Class ABEC 7 (P4)		Tolerances in $\mu\text{m}$									
Bore		0	0	0	0	0	0	0	0	0	0
Deviation	$\Delta_{\text{dmp}}$	-4	-5	-6	-7	-8	-10	-10	-12	-15	
Variation	$V_{\text{dp}}$	3	4	5	5	6	8	8	9	12	
Width deviation	$\Delta_{\text{Bs}}$	0	0	0	0	0	0	0	0	0	
		-80	-120	-120	-150	-200	-250	-250	-300	-350	
Width variation	$V_{\text{Bs}}$	2.5	2.5	3	4	4	5	5	6	8	
Radial runout	$K_{\text{ia}}$	2.5	3	4	4	5	6	6	8	9	
Axial runout	$S_{\text{d}}$	3	4	4	5	5	6	6	7	8	
Axial runout	$S_{\text{ia}}$	2	2	2	3	3	4	4	4	5	

Housing Washer		Dimensions in mm									
Nominal outside diameter	over	18	30	50	80	120	150	180	250	315	315
	including	30	50	80	120	150	180	250	315	400	
Tolerance Class ABEC 7 (P4)		Tolerances in $\mu\text{m}$									
Outside diameter		0	0	0	0	0	0	0	0	0	0
Deviation	$\Delta_{\text{Dmp}}$	-5	-6	-7	-8	-9	-10	-11	-13	-15	
Variation	$V_{\text{Dp}}$	4	5	5	6	7	8	8	10	11	
Width variation	$V_{\text{Cs}}$	2.5	2.5	3	4	5	5	7	7	8	
Radial runout	$K_{\text{ea}}$	4	5	5	6	7	8	10	11	13	
Variation of inclination	$S_{\text{D}}$	4	4	4	5	5	5	7	8	10	
Axial runout	$S_{\text{ea}}$	2	2	3	3	4	4	4	5	6	
Width deviation $\Delta_{\text{Cs}}$ is identical with $\Delta_{\text{Bs}}$ of the corresponding shaft washer.											

# TOLERANCES FOR SUPER PRECISION BEARINGS

## Tolerances for Axial-Radial Cylindrical Roller Bearings (RTC)

Shaft Washer		Dimensions in mm													
Nominal bore diameter	over	50	80	120	150	180	250	315	400	500	630	800	1000	1250	
	including	80	120	150	180	250	315	400	500	630	800	1000	1250	1600	
		Tolerances in $\mu\text{m}$													
Bore		0	0	0	0	0	0	0	0	0	0	0	0	0	
Deviation	$\Delta_{ds}$	-9	-10	-13	-13	-15	-18	-23	-27	-33	-40	-50	-65	-80	
Variation	$V_{dmp}$	3.5	4	5	5	6	7	9	10	12	15	19	25	30	
	$V_{dp}$	7	8	10	10	12	14	18	20	24	30	38	50	60	
Bearing height		+25	+25	+30	+30	+30	+40	+50	+60	+75	+100	+120	+150	+200	
Deviation	$\Delta_{Hs}$	-150	-150	-175	-175	-200	-250	-300	-350	-450	-600	-750	-900	-1200	
Cross section height		+25	+25	+30	+30	+30	+40	+50	+60	+75	+100	+120	+150	+200	
Deviation	$\Delta_{has}$	-25	-25	-30	-30	-30	-40	-50	-60	-75	-100	-120	-150	-200	
Radial runout	$K_{ia}$	3	3	3	4	4	5	5	6	7	8	8	9	11	
Wall thickness variation	$S_i$	3	3	3	4	4	5	5	6	7	8	8	9	11	
Wall thickness variation	$S_{i(T52E)}$	1.5	1.5	1.5	2	2	3	3	3	5	5	6	7	8	

Housing Washer		Dimensions in mm													
Nominal outside diameter	over	120	150	180	250	315	400	500	630	800	1000	1250	1600		
	including	150	180	250	315	400	500	630	800	1000	1250	1600	2000		
		Tolerances in $\mu\text{m}$													
Outside diameter		0	0	0	0	0	0	0	0	0	0	0	0	0	
Deviation	$\Delta_{Ds}$	-11	-13	-15	-18	-20	-23	-28	-35	-45	-55	-70	-85		
Variation	$V_{Dmp}$	4	5	6	7	8	9	10	13	17	20	27	32		
	$V_{Dp}$	8	10	12	14	16	18	20	26	34	40	54	64		
Radial runout $K_{ea}$ and wall thickness variation $S_e$ are identical with tolerance values $K_{ia}$ and $S_i$ for the shaft washer of the same bearing.															

# Corner Dimensions

## Limits for Corner Dimensions

### Symbols:

- $r_{smin}, r_{1smin}$  Symbol for the minimum corner dimensions in radial and axial direction
- $r_{smaxr}, r_{1smaxr}$  Symbol for the maximum corner dimensions in radial direction
- $r_{smaxa}, r_{1smaxa}$  Symbol for the maximum corner dimensions in axial direction

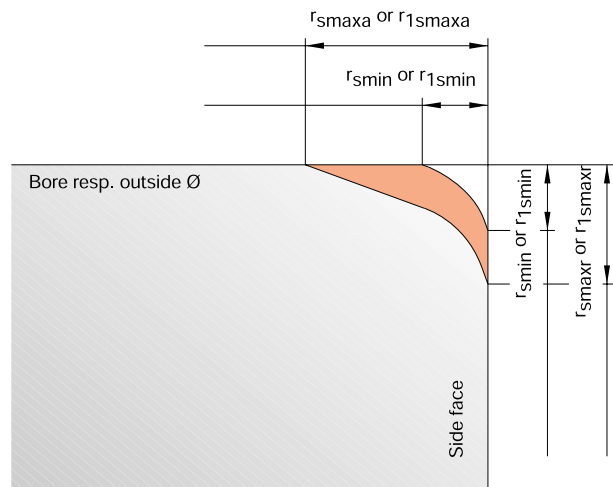

Corner Dimensions of Radial Bearings		Dimensions in mm																	
$r_{smin}, r_{1smin}$		0.1	0.15	0.2	0.3	0.3	0.3	0.6	0.6	0.6	1	1	1	1.1	1.1	1.1	1.5	1.5	1.5
Nominal bore diameter "d"	over including	25	25	40	40	120	120	40	250	400	50	400	500	120	400	500	120	400	800
$r_{smaxr}, r_{1smaxr}$	rad.	0.2	0.3	0.5	0.6	0.8	1	1	1.3	1.5	1.5	1.9	2.5	2	2.5	2.7	2.3	3	3.5
$r_{smaxa}, r_{1smaxa}$	ax.	0.4	0.6	0.8	1	1	1.7	2	2	2.6	3	3	3.5	3.5	4	4.5	4	5	5
$r_{smin}, r_{1smin}$		2	2	2	2.1	2.1	2.5	2.5	2.5	2.5	3	3	4	5	6	7.5			
Nominal bore diameter "d"	over including	80	220	800	280	1200	100	280	800	1200	280	1200	1200	2000	3000	3000			
$r_{smaxr}, r_{1smaxr}$	rad.	3	3.5	3.8	4	4.5	3.8	4.5	5	5	5	5.5	6.5	8	10	12.5			
$r_{smaxa}, r_{1smaxa}$	ax.	4.5	5	6	6.5	7	6	6	7	7.5	8	8	9	10	13	17			

Corner Dimensions of Thrust Bearings		Dimensions in mm																	
$r_{smin}, r_{1smin}$		0.1	0.15	0.2	0.3	0.3	0.6	1	1	1.1	1.5	2	2.1	3	4	5	6	7.5	
Nominal bore diameter "d"	over including	25	25	40	120	250	400	500	800	800	1200	1200	1200	2000	2000	3000	3000	3000	
$r_{smaxr}, r_{1smaxr}$	rad.	0.2	0.3	0.5	0.8	1	1.5	2.2	2.6	2.7	3.5	4	4.5	5.5	6.5	8	10	12.5	
$r_{smaxa}, r_{1smaxa}$	ax.	0.2	0.3	0.5	0.8	1	1.5	2.2	2.6	2.7	3.5	4	4.5	5.5	6.5	8	10	12.5	

# MACHINING TOLERANCES FOR MATING PARTS

The performance capability of super precision bearings in terms of speedability and running accuracy is continuously increasing. However, it will only be possible to exploit these enhanced performance capabilities if the precision level of the mating part is on the same level as that of the bearings.

The tolerances of dimension, form and position listed in the following tables have proven suitable in many super precision bearing applications. The values are a means for better and quicker fit selection and ensure reliable function and exchangeability. The mean roughness values  $R_a$  of the bearing seat surface finishes must not be exceeded so that the recommended fits are not altered significantly due to the smoothing effect.

The universally applicable rules of rolling bearing technology which consider the

- direction and effect of load
- rotation of inner or outer ring
- alteration of fit due to temperatures and centrifugal forces must also be observed.

## Shaft

### Tolerance Symbols

- $d$  = Nominal diameter of shaft or small end taper
- $d_1$  = Nominal diameter of large end taper  
 $d_1 = d + 1/12 \cdot L$
- $L$  = Length of taper  $L = 0.95 \cdot B$   
( $B$  = bearing width)
- $t_1 \text{ } \text{⌀}$  = Cylindrical form tolerance
- $t_2 \text{ } \text{⊙}$  = Roundness tolerance
- $t_3 \text{ } \text{▭}$  = Flatness tolerance
- $t_4 \text{ } \text{↗}$  = Axial runout tolerance
- $t_5 \text{ } \text{⊙}$  = Coaxiality tolerance
- $AT_D$  = Taper angle tolerance
- $R_a$  = Mean surface roughness

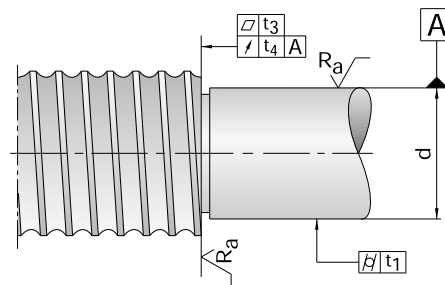
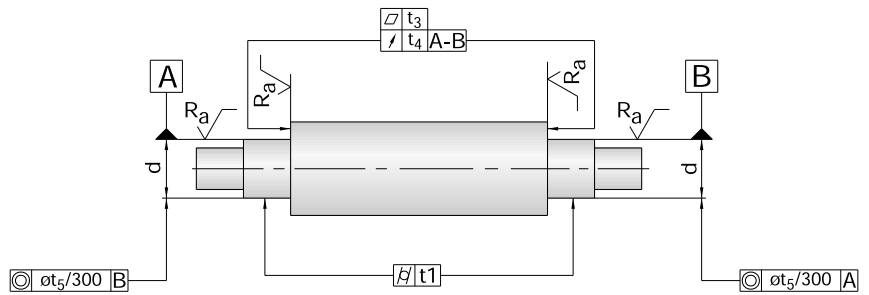
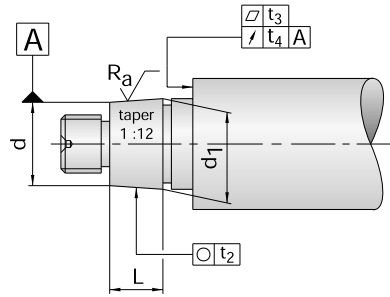

## Housing

### Tolerance Symbols

D = Nominal housing bore

$t_1$   $\varnothing$  = Cylindrical form tolerance

$t_3$   $\square$  = Flatness tolerance

$t_4$   $\nearrow$  = Axial runout tolerance

$t_5$   $\odot$  = Coaxiality tolerance

$R_a$  = Mean surface roughness

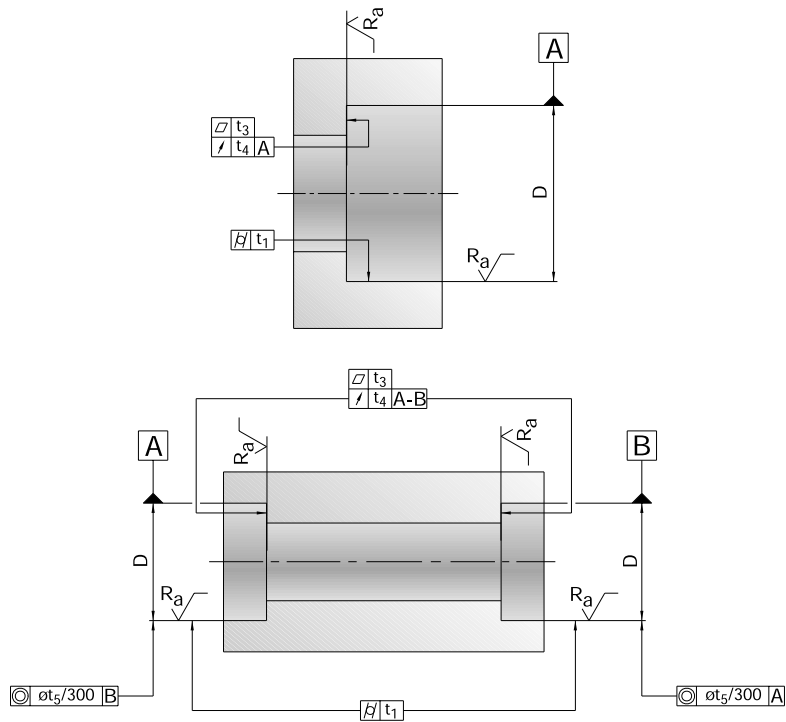

## Spacer sleeves

### Tolerance Symbols

$d_2$  = Nominal spacer sleeve bore

$D_2$  = Cylindrical form tolerance

$t_1$  = Zylinderform

$t_4$   $\varnothing$  = Axial runout tolerance

$t_6$   $\nearrow$  = Parallelism tolerance

$t_7$   $\parallel$  = Radial runout tolerance

$R_a$   $\nearrow$  = Mean surface roughness

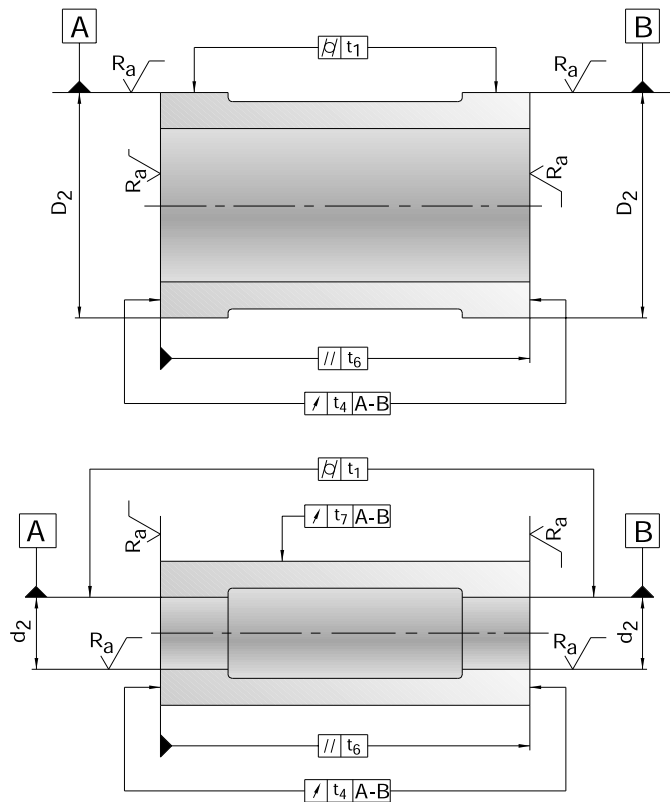

# MACHINING TOLERANCES FOR MATING PARTS

## Design of Surrounding Structure for Axial-Radial Cylindrical Roller Bearings

### Tolerance Symbols

$d_3$  = Nominal shaft diameter

$D_3$  = Nominal housing bore

$t_2$   $\bigcirc$  = Roundness tolerance

$t_6$   $//$  = Parallelism tolerance

$t_8$   $\perp$  = Perpendicularity tolerance

$R_a$  = Mean surface roughness

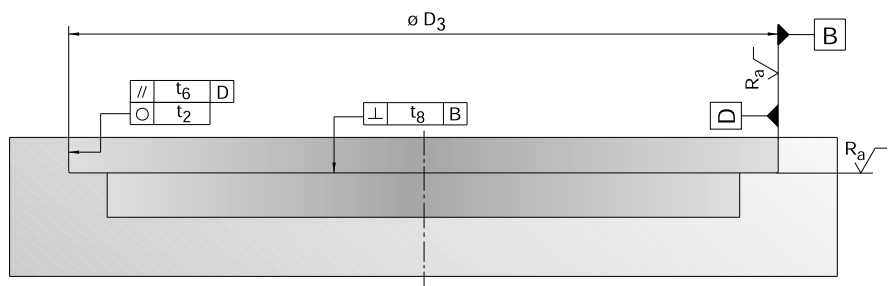
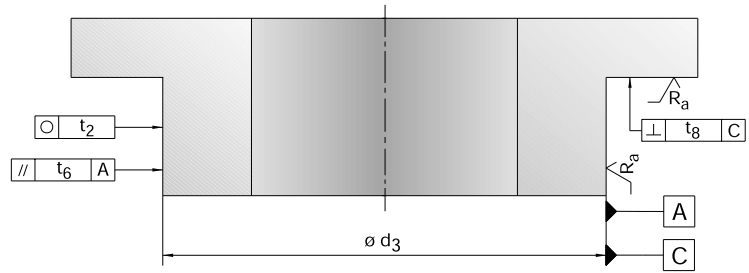



## Shafts and Housings for Spindle Bearings

### Tolerance Recommendations for Machining the Shafts for Spindle Bearings

Dimensions in mm

Nominal shaft diameter d	over	0	10	18	30	50	80	120	180	250	315	400	500
	including	10	18	30	50	80	120	180	250	315	400	500	630

Tolerances in  $\mu\text{m}$

Deviation of d		2	2.5	3	3.5	4	5	6	7	8	9	10	11
		-2	-2.5	-3	-3.5	-4	-5	-6	-7	-8	-9	-10	-11
Cylindricity	$t_1$	0.6	0.8	1	1	1.2	1.5	2	3	4	5	6	7
Flatness	$t_3$	0.6	0.8	1	1	1.2	1.5	2	3	4	5	6	7
Axial runout	$t_4$	1	1.2	1.5	1.5	2	2.5	3.5	4.5	6	7	8	9
Coaxiality	$t_5$	2.5	3	4	4	5	6	8	10	12	13	15	16
Mean surface roughness	$R_a$	0.2	0.2	0.2	0.2	0.4	0.4	0.4	0.4	0.8	0.8	0.8	0.8

### Tolerance Recommendations for Machining the Housings for Spindle Bearings

Dimensions in mm

Nominal housing diameter D	over	10	18	30	50	80	120	180	250	315	400	500	630
	including	18	30	50	80	120	180	250	315	400	500	630	800

Tolerances in  $\mu\text{m}$

Deviation of D	Locating bearing	+3	+4	+4	+5	+6	+8	+10	+12	+13	+15	+16	+17
	Floating bearing	-2	-2	-3	-3	-4	-4	-4	-4	-5	-5	-6	-7
		+7	+8	+10	+11	+14	+17	+21	+24	+27	+30	+33	+36
		+2	+2	+3	+3	+4	+5	+7	+8	+9	+10	+11	+12
Cylindricity	$t_1$	1.2	1.5	1.5	2	2.5	3.5	4.5	6	7	8	9	10
Flatness	$t_3$	1.2	1.5	1.5	2	2.5	3.5	4.5	6	7	8	9	10
Axial runout	$t_4$	2	2.5	2.5	3	4	5	7	8	9	10	11	12
Coaxiality	$t_5$	3	4	4	5	6	8	10	12	13	15	16	18
Mean surface roughness	$R_a$	0.4	0.4	0.4	0.4	0.8	0.8	0.8	1.6	1.6	1.6	1.6	1.6

# MACHINING TOLERANCES FOR MATING PARTS

## Inner and Outer Spacers

Tolerance Recommendations for Machining Inner Spacers													
Dimensions in mm													
Nominal sleeve bore diameter $d_2$	over including	0	10	18	30	50	80	120	180	250	315	400	500
		10	18	30	50	80	120	180	250	315	400	500	630
Tolerances in $\mu\text{m}$													
Deviation of $d_2$		9	11	13	16	19	22	25	29	32	36	40	44
		0	0	0	0	0	0	0	0	0	0	0	0
Cylindricity	$t_1$	2.5	3	4	4	5	6	8	10	12	13	15	16
Axial runout	$t_4$	1	1.2	1.5	1.5	2	2.5	3.5	4.5	6	7	8	9
Parallelism	$t_6$	1	1.2	1.5	1.5	2	2.5	3.5	4.5	6	7	8	9
Radial runout	$t_7$	2.5	3	4	4	5	6	8	10	12	13	15	16
Mean surface roughness (incl. side faces)	$R_a$	0.4	0.4	0.4	0.4	0.4	0.8	0.8	0.8	1.6	1.6	1.6	1.6

Tolerance Recommendations for Machining Outer Spacers													
Dimensions in mm													
Nominal outside sleeve diameter $D_2$	over including	10	18	30	50	80	120	180	250	315	400	500	630
		18	30	50	80	120	180	250	315	400	500	630	800
Tolerances in $\mu\text{m}$													
Deviation of $D_2$		-6	-7	-9	-10	-12	-14	-15	-17	-18	-20	-22	-24
		-17	-20	-25	-29	-34	-39	-44	-49	-54	-60	-66	-74
Cylindricity	$t_1$	3	4	4	5	6	8	10	12	13	15	16	18
Axial runout	$t_4$	2	2.5	2.5	3	4	5	7	8	9	10	11	12
Parallelism	$t_6$	1.2	1.5	1.5	2	2.5	3.5	4.5	6	7	8	9	10
Mean surface roughness (incl. side faces)	$R_a$	0.4	0.4	0.4	0.4	0.8	0.8	0.8	1.6	1.6	1.6	1.6	1.6

If not explicitly prescribed in the drawing, both inner and outer spacers should have the same length. For this purpose, the side faces of both spacers should be ground in one chucking.

## Non-Tapered Shafts for Cylindrical Roller Bearings

Tolerance Recommendations for Machining the Shafts for Cylindrical Roller Bearings (Cylindrical Bore)											
		Dimensions in mm									
Nominal shaft diameter d	over	18	30	50	80	120	180	250	315	400	500
	including	30	50	80	120	180	250	315	400	500	630
<b>Tolerance Class SP</b>		Tolerances in $\mu\text{m}$									
Deviation of d		3	3.5	4	5	6	7	8	9	10	11
		-3	-3.5	-4	-5	-6	-7	-8	-9	-10	-11
Cylindricity	$t_1$	1	1	1.2	1.5	2	3	4	5	6	7
Flatness	$t_3$	1	1	1.2	1.5	2	3	4	5	6	7
Axial runout	$t_4$	1.5	1.5	2	2.5	3.5	4.5	6	7	8	9
Coaxiality	$t_5$	4	4	5	6	8	10	12	13	15	16
Mean surface roughness	$R_a$	0.2	0.2	0.4	0.4	0.4	0.4	0.8	0.8	0.8	0.8
<b>Tolerance Class UP</b>		Tolerances in $\mu\text{m}$									
Deviation of d		2	2	2.5	3	4	5	6	6.5	7.5	8
		-2	-2	-2.5	-3	-4	-5	-6	-6.5	-7.5	-8
Cylindricity	$t_1$	0.6	0.6	0.8	1	1.2	2	2.5	3	4	5
Flatness	$t_3$	0.6	0.6	0.8	1	1.2	2	2.5	3	4	5
Axial runout	$t_4$	1	1	1.2	1.5	2	3	4	5	6	7
Coaxiality	$t_5$	2.5	2.5	3	4	5	7	8	9	10	11
Mean surface roughness	$R_a$	0.2	0.2	0.2	0.2	0.2	0.2	0.4	0.4	0.4	0.4

## Housings for Cylindrical Roller Bearings

Tolerance Recommendations for Machining the Housings for Cylindrical Roller Bearings											
		Dimensions in mm									
Nominal housing diameter D	over	30	50	80	120	180	250	315	400	500	630
	including	50	80	120	180	250	315	400	500	630	800
<b>Tolerance Class SP</b>		Tolerances in $\mu\text{m}$									
Deviation of D		+2	+3	+2	+3	+2	+3	+3	+2	0	0
		-9	-10	-13	-15	-18	-20	-22	-25	-30	-35
Cylindricity	$t_1$	1.5	2	2.5	3.5	4.5	6	7	8	9	10
Flatness	$t_3$	1.5	2	2.5	3.5	4.5	6	7	8	9	10
Axial runout	$t_4$	2.5	3	4	5	7	8	9	10	11	12
Coaxiality	$t_5$	4	5	6	8	10	12	13	15	16	18
Mean surface roughness	$R_a$	0.4	0.4	0.8	0.8	0.8	1.6	1.6	1.6	1.6	1.6
<b>Tolerance Class UP</b>		Tolerances in $\mu\text{m}$									
Deviation of D		+1	+1	+1	+1	0	0	+1	0	0	0
		-6	-7	-9	-11	-14	-16	-17	-20	-24	-28
Cylindricity	$t_1$	1	1.2	1.5	2	3	4	5	6	7	8
Flatness	$t_3$	1	1.2	1.5	2	3	4	5	6	7	8
Axial runout	$t_4$	1.5	2	2.5	3.5	4.5	6	7	8	9	10
Coaxiality	$t_5$	2.5	3	4	5	7	8	9	10	11	12
Mean surface roughness	$R_a$	0.2	0.4	0.4	0.4	0.4	0.8	0.8	0.8	1.6	1.6

# MACHINING TOLERANCES FOR MATING PARTS

## Tapered Shafts and Taper Angles for Cylindrical Roller Bearings

Tolerance Recommendations for Machining the Tapered Shafts for Cylindrical Roller Bearings																					
		Dimensions in mm																			
Nominal shaft diameter d	over	18	30	40	50	65	80	100	120	140	160	180	200	225	250	280	315	355	400	450	500
	including	30	40	50	65	80	100	120	140	160	180	200	225	250	280	315	355	400	450	500	560
<b>Tolerance Class SP</b>		Tolerances in $\mu\text{m}$																			
Deviation of small-end taper diameter		+73	+91	+108	+135	+159	+193	+225	+266	+298	+328	+370	+405	+445	+498	+548	+615	+685	+767	+847	+928
		+64	+80	+97	+122	+146	+178	+210	+248	+280	+310	+350	+385	+425	+475	+525	+590	+660	+740	+820	+900
Roundness	$t_2$	1	1	1	1.2	1.2	1.5	1.5	2	2	2	3	3	3	4	4	5	5	6	6	7
Flatness	$t_3$	1	1	1	1.2	1.2	1.5	1.5	2	2	2	3	3	3	4	4	5	5	6	6	7
Axial runout	$t_4$	1.5	1.5	1.5	2	2	2.5	2.5	3.5	3.5	3.5	4.5	4.5	4.5	6	6	7	7	8	8	9
Mean surface roughn. $R_a$		0.2	0.2	0.2	0.2	0.2	0.2	0.2	0.2	0.2	0.2	0.2	0.2	0.2	0.4	0.4	0.4	0.4	0.4	0.4	0.4
<b>Tolerance Class UP</b>		Tolerances in $\mu\text{m}$																			
Deviation of large-end taper diameter		+73	+91	+108	+135	+159	+193	+225	+266	+298	+328	+370	+405	+445	+498	+548	+615	+685	+767	+847	+928
		+64	+80	+97	+122	+146	+178	+210	+248	+280	+310	+350	+385	+425	+475	+525	+590	+660	+740	+820	+900
Roundness	$t_2$	0.6	0.6	0.6	0.8	0.8	1	1	1.2	1.2	1.2	2	2	2	2.5	2.5	3	3	4	4	5
Flatness	$t_3$	0.6	0.6	0.6	0.8	0.8	1	1	1.2	1.2	1.2	2	2	2	2.5	2.5	3	3	4	4	5
Axial runout	$t_4$	1	1	1	1.2	1.2	1.5	1.5	2	2	2	3	3	3	4	4	5	5	6	6	7
Mean surface roughn. $R_a$		0.2	0.2	0.2	0.2	0.2	0.2	0.2	0.2	0.2	0.2	0.2	0.2	0.2	0.4	0.4	0.4	0.4	0.4	0.4	0.4

Deviation of Taper Angle													
		Dimensions in mm											
Nominal taper length L		>16...25		>25...40		>40...63		>63...100		>100...160		>160...250	
	<b>Tolerance Class SP</b>		Tolerances in $\mu\text{m}$										
Taper angle tolerance $AT_D$		+2	+3.2	+2.5	+4	+3.2	+5	+4	+6.3	+5	+8	+6.3	+10
		0	0	0	0	0	0	0	0	0	0	0	0
<b>Tolerance Class UP</b>		Tolerances in $\mu\text{m}$											
Taper angle tolerance $AT_D$		+1.3	+2	+1.6	+2.5	+2	+3.2	+2.5	+4	+3.2	+5	+4	+6.3
		0	0	0	0	0	0	0	0	0	0	0	0

The taper angle tolerance  $AT_D$  is measured vertically to the axis and is defined as a diameter difference.

When using FAG taper measuring instruments MGK 132, the listed  $AT_D$  values must be cut by half (inclination angle tolerance).

The taper angle tolerance  $AT_D$  is determined through interpolation for taper lengths with nominal dimensions which lie in between the values listed in the tables.

Example: Taper length 50 mm, bearing of tolerance class SP.

$$AT_D = AT_{DU} + \frac{\Delta AT_D}{\Delta L} \cdot (L - L_U) = 3.2 + \frac{5 - 3.2}{63 - 40} \cdot (50 - 40) = 3.98 \mu\text{m} \quad \text{The taper angle tolerance } AT_D = + 4 \mu\text{m}$$

## Shafts and Housings for Angular Contact Thrust Ball Bearings (Series 2344 and 2347)

### Tolerance Recommendations for Machining the Shafts for Double Row Angular Contact Thrust Ball Bearings (2344..., 2347...)

		Dimensions in mm								
Nominal shaft diameter	over	18	30	50	80	120	180	250	315	400
	including	30	50	80	120	180	250	315	400	500

#### Tolerance Class SP

Tolerances in  $\mu\text{m}$

Deviation of d		0	0	0	0	0	0	0	0	0
		-6	-7	-8	-10	-12	-14	-16	-18	-20
Cylindricity	$t_1$	1	1	1.2	1.5	2	3	4	5	6
Flatness	$t_3$	1	1	1.2	1.5	2	3	4	5	6
Axial runout	$t_4$	1.5	1.5	2	2.5	3.5	4.5	6	7	8
Mean surface roughness	$R_a$	0.2	0.2	0.4	0.4	0.4	0.4	0.8	0.8	0.8

#### Tolerance Class UP

Tolerances in  $\mu\text{m}$

Deviation of d		0	0	0	0	0	0	0	0	0
		-4	-4	-5	-6	-8	-10	-12	-13	-15
Cylindricity	$t_1$	0.6	0.6	0.8	1	1.2	2	2.5	3	4
Flatness	$t_3$	0.6	0.6	0.8	1	1.2	2	2.5	3	4
Axial runout	$t_4$	1	1	1.2	1.5	2	3	4	5	6
Mean surface roughness	$R_a$	0.2	0.2	0.2	0.2	0.2	0.2	0.4	0.4	0.4

### Tolerance Recommendations for Machining the Housings for Double Row Angular Contact Thrust Ball Bearings (2344..., 2347...)

		Dimensions in mm									
Nominal housing diameter D	over	30	50	80	120	180	250	315	400	500	630
	including	50	80	120	180	250	315	400	500	630	800

#### Tolerance Class SP

Tolerances in  $\mu\text{m}$

Deviation of D		+2	+3	+2	+3	+2	+3	+3	+2	0	0
		-9	-10	-13	-15	-18	-20	-22	-25	-30	-35
Cylindricity	$t_1$	1.5	2	2.5	3.5	4.5	6	7	8	9	10
Flatness	$t_3$	1	1.2	1.5	2	3	4	5	6	7	8
Axial runout	$t_4$	1.5	2	2.5	3.5	4.5	6	7	8	9	10
Mean surface roughness	$R_a$	0.8	0.8	0.8	0.8	0.8	1.6	1.6	1.6	1.6	1.6

#### Tolerance Class UP

Tolerances in  $\mu\text{m}$

Deviation of D		+1	+1	+1	+1	0	0	+1	0	0	0
		-6	-7	-9	-11	-14	-16	-17	-20	-24	-28
Cylindricity	$t_1$	1	1.2	1.5	2	3	4	5	6	7	8
Flatness	$t_3$	0.6	0.8	1	1.2	2	2.5	3	4	5	6
Axial runout	$t_4$	1	1.2	1.5	2	3	4	5	6	7	8
Mean surface roughness	$R_a$	0.2	0.4	0.4	0.4	0.4	0.8	0.8	0.8	1.6	1.6

## MACHINING TOLERANCES FOR MATING PARTS

### Shafts and Housings for Ball Screw Support Bearings (BSB, 7602, 7603)

Tolerance Recommendations for Machining the Shafts for Ball Screw Support Bearings									
Dimensions in mm									
Nominal shaft diameter d	over including	10	18	30	50	80	120	180	250
		18	30	50	80	120	180	250	315
Tolerances in $\mu\text{m}$									
Deviation of d		0	0	0	0	0	0	0	0
		-8	-9	-11	-13	-15	-18	-20	-23
Cylindricity	$t_1$	2	2.5	2.5	3	4	5	7	8
Flatness	$t_3$	1.2	1.5	1.5	2	2.5	3.5	4.5	6
Axial runout	$t_4$	2	2.5	2.5	3	4	5	7	8
Mean surface roughness	$R_a$	0.4	0.4	0.4	0.4	0.4	0.4	0.8	0.8

Tolerance Recommendations for Machining the Housings for Ball Screw Support Bearings									
Dimensions in mm									
Nominal housing diameter D	over including	18	30	50	80	120	180	250	315
		30	50	80	120	180	250	315	400
Tolerances in $\mu\text{m}$									
Deviation of D		+8	+10	+13	+16	+18	+22	+25	+29
		-5	-6	-6	-6	-7	-7	-7	-7
Cylindricity	$t_1$	2.5	2.5	3	4	5	7	8	9
Flatness	$t_3$	2.5	2.5	3	4	5	7	8	9
Axial runout	$t_4$	4	4	5	6	8	10	12	13
Mean surface roughness	$R_a$	0.8	0.8	0.8	0.8	0.8	0.8	1.6	1.6

## Mating Structure for Axial-Radial Cylindrical Roller Bearings (RTC)

### Tolerance Recommendations for Machining the Shafts for Axial-Radial Cylindrical Roller Bearings

Dimensions in mm

Nominal shaft diameter $d_3$	over including	50	80	120	150	180	250	315	400	500	630	800	1000	1250
		80	120	150	180	250	315	400	500	630	800	1000	1250	1600

Tolerances in  $\mu\text{m}$

Deviation of $d_3$		0	0	0	0	0	0	0	0	0	0	0	0	0
		-13	-15	-18	-18	-20	-23	-25	-27	-28	-32	-36	-42	-50
Roundness	$t_2$	5	6	8	8	10	12	13	15	16	18	20	24	28
Parallelism	$t_6$	3	4	5	5	7	8	9	10	11	12	14	16	20
Perpendicularity	$t_8$	3	4	5	5	7	8	9	10	11	12	14	16	20
Mean surface roughness	$R_a$	0.4	0.4	0.8	0.8	0.8	0.8	0.8	0.8	1.6	1.6	1.6	1.6	1.6

### Tolerance Recommendations for Machining the Housings for Axial-Radial Cylindrical Roller Bearings

Dimensions in mm

Nominal housing diameter $D_3$	over including	120	150	180	250	315	400	500	630	800	1000	1250	1600
		150	180	250	315	400	500	630	800	1000	1250	1600	2000

Tolerances in  $\mu\text{m}$

Deviation of $D_3$		+18	+18	+22	+25	+29	+33	+34	+38	+44	+52	+64	+76
		-7	-7	-7	-7	-7	-7	-10	-12	-12	-14	-14	-16
Roundness	$t_2$	8	8	10	12	13	15	16	18	20	24	28	32
Parallelism	$t_6$	5	5	7	8	9	10	11	12	14	16	20	22
Perpendicularity	$t_8$	5	5	7	8	9	10	11	12	14	16	20	22
Mean surface roughness	$R_a$	0.8	0.8	0.8	0.8	0.8	0.8	1.6	1.6	1.6	1.6	1.6	1.6

## SPEED-DEPENDENT FITS

Barden super precision bearings can be used at maximum speeds. Speed indices of up to  $1.5 \cdot 10^6$  mm/min dN are attainable with grease lubrication, while oil-lubricated bearings can attain speeds as high as  $3.0 \cdot 10^6$  mm/min and beyond. Such high speeds cause high centrifugal forces which act on the inner rings and cause them to expand. The effect is greater on the inner ring than on the shaft.

The ring expansion leads to a lifting off of the inner ring from the shaft and thus to clearance between inner ring and shaft.

The result is fretting corrosion and, possibly, creeping of the inner ring

on the shaft, poor shaft guidance with increased tendency for vibration and reduced bearing performance due to possible misalignment. These effects should be avoided through a correspondingly tight fit between the inner ring and shaft.

The required interference can be obtained from Diagram 18. The values determined in this way yield a fit with a remaining interference of  $1 \mu\text{m}$  at maximum speed.

High interference fits lead to an increase in preload, particularly in rigidly preloaded bearing arrangements. This in turn leads to increased heat generation in the bearing arrangement as well as

speedability losses. This preload increase must be compensated by appropriate measures. With values  $n^2 \cdot f_w > 1.2$  (orange zone in Diagram 18), it is advisable to consult the Barden application engineering department.

The value  $f_w$  can be obtained from Diagram 19 (large ball design) and Diagram 20 (small ball design). If value  $n_2 \cdot f_w < 1.2$ , the resulting shaft dimension is as follows:

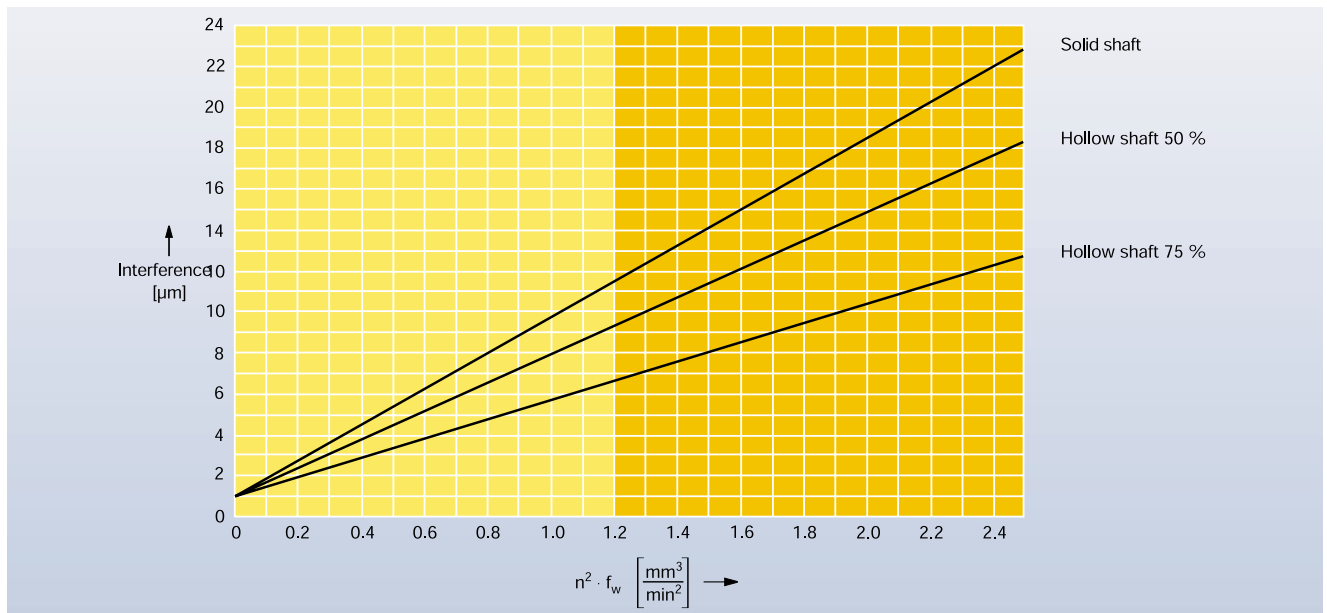

**18: Speed-dependent determination of interference shaft/inner ring**



**Example:**

CZSB1914ERRUL

Speed  $n = 16,000 \text{ min}^{-1}$

Actual dimension of inner ring:

$70 \text{ mm} - 3 \text{ }\mu\text{m} = 69.997 \text{ mm}$ .

The deviation from the nominal dimension is indicated on the bearing ring.

For a hollow shaft of 35 mm bore (50% of diameter)

$$f_w = 4.30 \cdot 10^{-9} \text{ (see Diagram 20)}$$

$$n^2 \cdot f_w = 1.1$$

The value 1.1 and curve “Hollow shaft 50%” (Diagram 18) result in a required interference of 9  $\mu\text{m}$ .

Therefore, the actual dimension of the shaft must be 70.006 mm to ensure that the inner ring will still be tightly located on the shaft at a speed of  $n = 16,000 \text{ min}^{-1}$ .

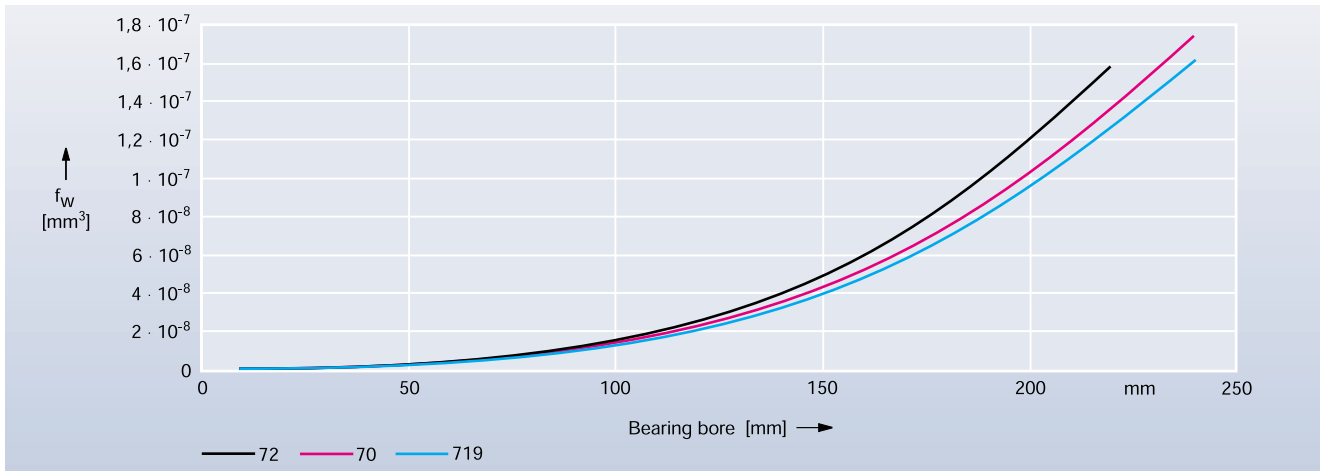

**19: Factor  $f_w$  for the speed-dependent determination of the inner ring/shaft fit for bearing series 1800HC/E, 1900HC/E, 100HC/E, 200HC/E and their ceramic and X-life ultra versions.**

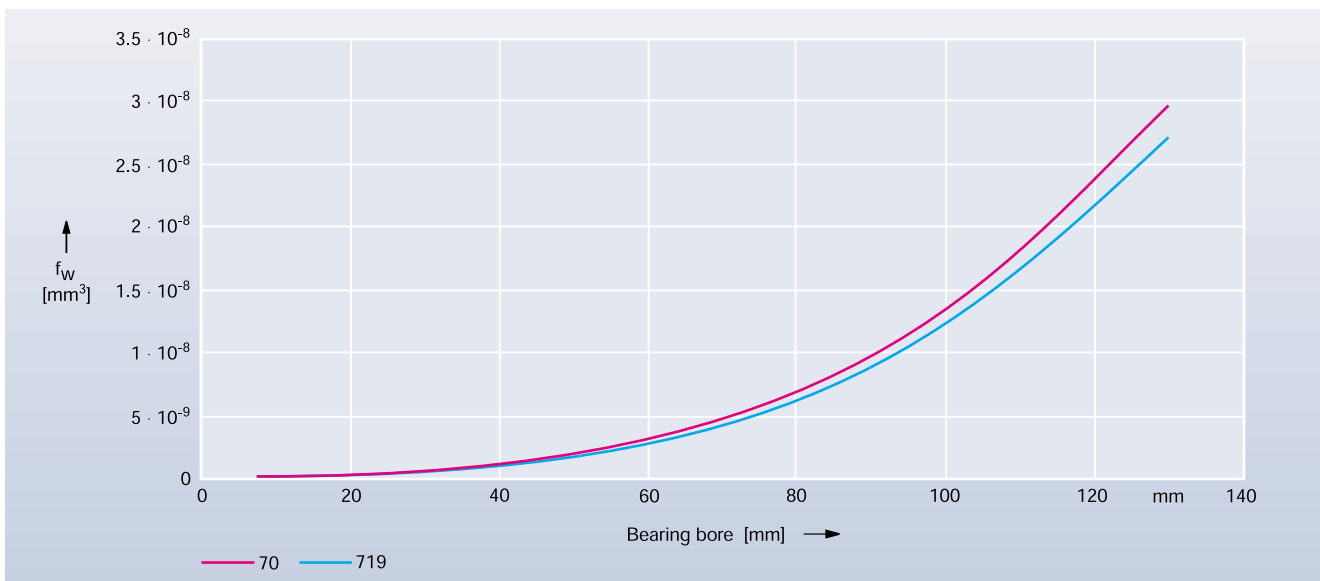

**20: Factor  $f_w$  for the speed-dependent determination of the inner ring/shaft fit for bearing series ZSB1800C/E, ZSB1900C/E, ZSB100C/E and their ceramic and X-life ultra versions.**

# SPEEDS







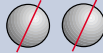

The speeds attainable by a specific bearing arrangement depend on the overall energy balance of the system. The number of bearings, their position, internal stress (clearance or preload), external stress and lubrication on the one hand as well as the heat dissipation conditions on the other hand are the decisive factors. The attainable speed figures in the bearing tables are reference values that may be higher or lower, depending on the mentioned conditions. Contact Barden Application Engineering for assistance.

## Spindle Bearings

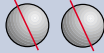
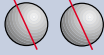
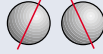

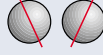
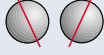
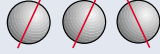
The attainable speeds stated in the bearing tables are an indication of the speedability of **elastically** preloaded single bearings. These speeds are not attainable with rigidly preloaded bearings, bearing pairs or groups. The reduction factors to be assumed here are shown in Table 21.

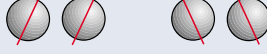
## Ball Screw Support Bearings (BSB, 7602, 7603)

The permissible speeds for grease-lubricated bearings are shown in the bearing table. The indicated values apply to a **rigidly** preloaded bearing pair in a back-to-back or face-to-face arrangement. For other bearing arrangements the reduction factors shown in Table 22 have to be used.

Bearing Arrangement	Factor $f_p$ , Bearing Preload		
	L	M	H
Large bearing distance			
			0.85
		0.75	0.5
		0.8	0.5
		0.75	0.65
Locating bearing	Floating bearing		
		0.75	0.6
		0.65	0.5
		0.65	0.5
		0.72	0.57

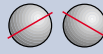
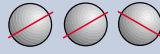
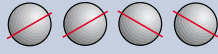
21: Speed reduction ( $n^* \cdot f_p$ ) for spindle bearing sets

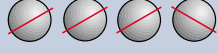
Bearing Arrangement	Attainable Speeds
	$1.0 \cdot n^*$
	$0.70 \cdot n^*$
	$0.85 \cdot n^*$
	$0.75 \cdot n^*$
	$0.65 \cdot n^*$

\* Speed see bearing tables

22: Speed reduction for ball screw support bearings

## Cylindrical Roller Bearings

The attainable speed for cylindrical roller bearings is determined depending on the adjusted radial clearance. See Table 23 for corresponding indications.

Mounting Clearance/Preload	Attainable Speeds
Single row cylindrical roller bearings	
- 5 ... 0 [ $\mu\text{m}$ ]	$< 0.75 \cdot n^*$ grease
0 [ $\mu\text{m}$ ] (zero clearance)	$0.75 \dots 1.0 \cdot n^*$ grease
0 ... 3 [ $\mu\text{m}$ ]	$1 \dots 1.1 \cdot n^*$ grease
0 ... 3 [ $\mu\text{m}$ ]	$1.0 \cdot n^*$ oil
Double row cylindrical roller bearings	
- 5 ... 0 [ $\mu\text{m}$ ]	$< 0.50 \cdot n^*$ grease
$2 \cdot 10^{-5} \cdot d_m$ [mm]	$0.50 \dots 0.75 \cdot n^*$ grease
$4 \cdot 10^{-5} \cdot d_m$ [mm]	$0.75 \dots 1.0 \cdot n^*$ grease
$1 \cdot 10^{-4} \cdot d_m$ [mm]	$1.0 \cdot n^*$ oil
* Speeds see bearing tables	
$d_m = (d + D)/2$	
These values apply to $\Delta T$ up to 5 K between inner and outer ring.	

### 23: Speed n for cylindrical roller bearings

## DEFLECTION AND RIGIDITY

High running accuracies even under alternating loads can be achieved with zero-clearance bearing arrangements. They are arranged and preloaded depending on the load and required rigidity. The rigidity can be increased by using bearing sets.



### Spindle Bearings

The axial rigidity values stated in the bearing tables apply to bearing pairs in back-to-back or face-to-face arrangement. The radial rigidity can be estimated from the axial rigidity by means of a factor.

$$S_r \approx 6 \cdot S_a \text{ for } \alpha = 15^\circ$$

$$S_r \approx 2 \cdot S_a \text{ for } \alpha = 25^\circ$$

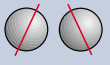
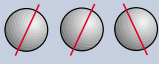
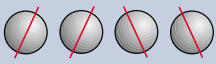
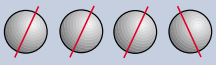
Sets of more than two bearings feature increased rigidity values. Table 24 shows the determination of the axial rigidity with a centrally acting axial load. The radial rigidity for such sets with a radial load acting on the center of the set is calculated according to Table 25.

Bearing Arrangement	Suffix	$S_a'$ N/ $\mu\text{m}$	$K_{aE}$ $\alpha = 15^\circ$ and $\alpha = 25^\circ$ N
	DB	$S_a^{1)}$	$3 \cdot F_V$
	TBT	$1.64 \cdot S_a$	$6 \cdot F_V$
	QBC	$2 \cdot S_a$	$6 \cdot F_V$
	QBT	$2.24 \cdot S_a$	$9 \cdot F_V$
	PBC	$2.64 \cdot S_a$	$9 \cdot F_V$

$K_{aE}$  = Unloading force     $F_V$  = Preloading force    <sup>1)</sup> Bearing tables

**24: Axial rigidity  $S_a'$  of a bearing set with a centrally acting axial load**

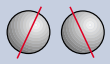
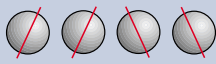
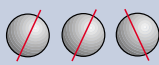
Bearing Arrangement	Suffix	$S_r'$ N/ $\mu\text{m}$
	DB	$S_r$
	QBC	$2 \cdot S_r$
	TBT	$1.36 \cdot S_r$

**25: Radial rigidity  $S_r'$  of a bearing set; the radial load acting on the center of the set**

### Ball Screw Support Bearings (BSB, 7602, 7603)

The axial rigidity  $S_a$  and the unloading forces  $K_{aE}$  can be obtained from the bearing tables for bearing pairs in face-to-face or back-to-back arrangement. Sets of more than two bearings feature increased rigidity values. The values for the axial rigidity and unloading force that apply in such cases can be obtained from Table 26.

### Double Direction Angular Contact Thrust Ball Bearings of Series 2344 and 2347

$$\delta_a = F_a / S_a$$

$\delta_a$  = axial deflection [ $\mu\text{m}$ ]

$F_a$  = axial load [N]

$S_a$  = axial rigidity [N/ $\mu\text{m}$ ]

The values  $S_a$  (see bearing tables) are valid up to an axial load corresponding to 2.2 % of the dynamic load rating C.

Bearing Arrangement	$S_a'$ N/ $\mu\text{m}$	$K_{aE}'$ N
	$S_a^{1)}$	$K_{aE}^{1)}$
	$2 \cdot S_a$	$2 \cdot K_{aE}$
	$3 \cdot S_a$	$3 \cdot K_{aE}$
	$4 \cdot S_a$	$4 \cdot K_{aE}$

<sup>1)</sup> Bearing tables

**26: Axial rigidity  $S_a'$  and unloading force  $K_{aE}'$  of a bearing set at centrally acting axial load**

### Axial-Radial Cylindrical Roller Bearings RTC

The values  $S_a'$ ,  $S_r$  and  $S_k$  in the bearing tables relate exclusively to the elastic deformation at the contact points of the rollers while the values  $S_a'$  and  $S_k'$  also consider the deformation of the center disk and the bolts.

The latter values  $S_a'$  and  $K_{aE}'$  can be increased by stiffening the bearing superstructure.

The values for the tilting rigidity are based on medium axial and radial preload.

# HANDLING OF SUPER PRECISION BEARINGS

## Assembly

### Handling of Super Precision Bearings

Barden super precision bearings are manufactured in clean surroundings, undergo intensive inspections and are packaged with great care. In order to preserve the full performance capacity of the bearings, they have to be handled carefully during spindle assembly. A separate, clean room for assembly offers the best environment for bearing installation. Assembly can be divided into the following steps:

#### Preparation of Parts

Only inspected and approved parts should be used for assembly. Depending on the component, the approval procedure consists of a dimensional inspection, optical inspection or an additional pre-balancing procedure.

#### Calibration of Parts

Fits have a decisive influence on bearing function. Therefore it is sometimes advisable to calibrate bearings to the spindle or housing diameter. In the case of spindle bearings the bore and housing tolerances are divided into groups, the mean tolerance of which is indicated on the packaging and the bearing itself. The spindle bearing width as a deviation of the nominal dimension is also indicated on the bearing.

#### Spindle Head Adjustments

In order to obtain optimum performance or achieve an accurate position of the spindle in relation to the housing, it may be necessary to make special adjustments. This applies for instance to the face cover that serves for axially clamping the bearings in the housing. Prior to

clamping, the bearing should feature an adequate gap. The adjustment of spacers is advisable for high-speed spindles to compensate for the influence of fit and ring expansion on preload.

#### Lubricating Greases

Barden super precision bearings are manufactured in such a way that washing the bearing prior to greasing is not required. The grease filling can be obtained from Tables 24 and 25 (page 162-163). Precise grease quantities and a good distribution of the grease in the bearing can be achieved by simply using a syringe. Ready-to-use, grease-filled syringes and pre-greased bearings are also available from Barden.

#### Mounting

When mounting the bearing onto the shaft or inside the housing, forces must — under no circumstances — be transferred through the rolling elements. Components that have to be mounted with tight fits (interference fits) should be heated prior to mounting. This can be done in a simple, quick and clean way by using inductive heating devices. Values for the axial clamping of bearings on the shaft by means of a precision nut are indicated in Table 38. We recommend initially tightening the nut with three times the nominal torque, loosening it again, then tightening using nominal torque to rule out or reduce setting effects.

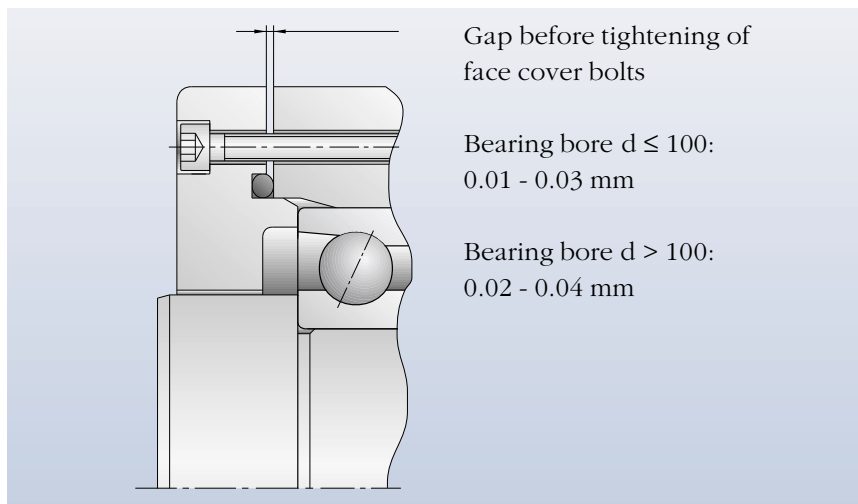

#### Recommended adjustment of face covers

## Assembly

Bore/Bore Reference Number	Clamping Force				Tightening Torque				Thread
	1800H kN	1900H	100H	200H	1800H Nm	1900H	100H	200H	
6			0.16				0.13		M6x0.5
7			0.26				0.25		M7x0.5
8			0.29				0.32		M8x0.75
9			0.31				0.40		M9x0.75
00	0.17	0.34	0.55	0.48	0.24	0.48	0.78	0.68	M10x0.75
01	0.20	0.40	0.77	0.55	0.33	0.67	1.3	0.93	M12x1
02	0.24	0.48	0.77	0.66	0.51	1.0	1.6	1.4	M15x1
03	0.27	0.54	0.86	1.1	0.64	1.3	2.1	2.6	M17x1
04	0.56	0.99	1.0	1.2	1.6	2.8	2.9	3.3	M20x1
05	0.69	1.2	1.3	1.4	2.4	4.2	4.4	4.9	M25x1.5
06	0.82	1.4	1.4	2.2	3.4	6.0	5.7	9.4	M30x1.5
07	0.94	1.7	1.6	3.1	4.6	8.3	7.6	15	M35x1.5
08	1.1	1.9	1.8	2.8	6.0	11	9.8	15	M40x1.5
09	0.8	1.9	2.0	2.6	5.3	12	12	17	M45x1.5
10	1.8	2.1	2.2	2.4	12	15	15	17	M50x1.5
11	2.1	1.0	2.7	2.6	16	8	21	20	M55x2
12	2.0	1.1	2.9	4.4	17	9	24	37	M60x2
13	2.1	1.2	3.1	6.0	19	11	28	54	M65x2
14	2.2	2.5	3.3	5.7	22	24	33	56	M70x2
15	2.4	2.6	3.5	6.1	25	28	37	64	M75x2
16	2.5	2.8	5.1	5.6	29	31	58	63	M80x2
17	2.0	4.0	5.4	8.2	24	47	65	98	M85x2
18	2.2	4.2	8.7	10	27	53	110	130	M90x2
19	2.3	4.4	7.6	12	30	59	101	163	M95x2
20	2.4	4.6	7.9	11	34	65	111	154	M100x2
21	2.5	4.9	6.3	13	37	72	92	197	M105x2
22	4.3	5.1	6.6	16	66	78	101	246	M110x2
24	4.7	7.5	7.1	25	78	126	119	418	M120x2
26	5.3	6.5	9.9	16	96	118	180	289	M130x2
28	5.7	7.0	11	30	111	136	207	580	M140x2
30	8.1	6.2	12	45	170	131	254	951	M150x2
32	8.6	6.6	16	57	193	148	349	1274	M160x3
34	12	7.0	19	63	284	167	462	1493	M170x3
36	13	13	24	61	318	338	593	1534	M180x3
38	15	14	25	64	391	376	659	1699	M190x3
40	15	19	29	85	432	539	823	2391	M200x3
44	17	21	30	115	521	648	910	3557	Tr220x4
48	22	23	36		731	769	1214		Tr240x4
52		42				1530			Tr260x4
56		45				1769			Tr280x4
60		52				2194			Tr300x4
64		56				2488			Tr320x5
68		59				2801			Tr340x5
72		62				3132			Tr360x5

Values correspond to a side face pressure of  $\approx 10$  MPa.

### 27: Preload clamping forces and corresponding nut tightening torques for spindle bearing inner rings

# HANDLING OF SUPER PRECISION BEARINGS

## Assembly • Training

### Clearance Adjustment in Cylindrical Roller Bearings

Cylindrical roller bearings with tapered bore are mounted with a small clearance, line-to-line fit or slight preload. This can be done to the precision of  $\pm 1 \mu\text{m}$  with the help of an FAG boundary circle measuring device. If such a measuring device is not available, a fairly exact clearance adjustment can be achieved by measuring the axial drive-up distance of the inner ring onto the tapered shaft seating, **taper 1:12**. This drive-up distance is approximately **15 times** larger than the radial expansion affected in this way. Surface smoothing and the elastic behavior of the spindle and the inner ring also have an effect which may vary slightly.

Score marks can be safely avoided when mounting cylindrical roller bearings if the inner ring is not tilted relative to the outer ring and the spindle is continually turned. Heating the housing and the outer ring facilitates the mounting procedure here, as well.

### Test Run

With grease-lubricated bearings, a special grease distribution run-in procedure has to be carried out prior to a test run. Details on grease distribution can be obtained from Diagram 16 (see page 165).

### Documentation

Quality assurance documentation is created by recording measurement data during mounting procedures. Important measurements to document include:

- Seating diameter, interference
- Spacer difference dimensions
- Steady-state temperature
- Radial and axial runout.

### Training

The handling of super precision bearings, as well as various mounting and measuring devices, requires a high degree of expertise. The performance capacity of super precision bearings can only be fully realized when the appropriate bearing is selected and mounted in the correct way.

Barden has made it its business to pass on the knowledge about the complicated processes in super precision bearings in specially conceived training programs. These offer differentiated training concepts that are optimally tailored to the concrete requirements of the respective target groups (master craftsmen, assembly technicians, engineers, commercial staff).

The technical seminars deal with the improvement of existing designs by using high-performance, innovative products. In addition, they also introduce the latest newly developed products.

The orientation of each specific subject is kept as practical as possible. In addition to the required basic knowledge about function and application of super precision bearings, assembly technicians are invited to make themselves familiar with the handling of mounting devices and measuring instruments under expert direction in Barden workshops.



# BARDEN LITERATURE AND WEB SITES

## The World of Super Precision Bearings



Our Specialty Bearing catalog contains information on other super precision products. It is also available on CD-ROM.

To request a copy of the catalog, or for further information on other Barden technical engineering publications, please contact your local Barden sales representative or call 1-203-744-2211 (Toll Free at 1-800-243-1060).



Barden's website — [www.bardenbearings.com](http://www.bardenbearings.com) — contains additional information on other Barden super-precision bearings.

Information about spindle monitoring, bearing calculations, drawings and other FAG precision applications can be found on the FAG website at [www.fag.de](http://www.fag.de).



Every care has been taken to ensure the accuracy of the information contained in this catalog. No liability can be accepted for any errors or omissions. We reserve the right to make any changes necessitated by technological progress.

© by Barden 2002. The contents of this publication may not be reproduced unless permission is granted.

# INDEX

- ABEC standards ..... 6, 168
- Assembly ..... 196-198
  - Calibration ..... 10, 196
  - Clearance adjustment in cylindrical roller bearings ..... 198
  - Documentation ..... 198
  - Handling super precision bearings ..... 196
  - Lubricating greases ..... 161-163, 196
  - Mounting ..... 196
  - Preload clamping forces ..... 197
  - Preparation of parts ..... 196
  - Spindle head adjustments ..... 196
  - Test run ..... 198
- Attainable speeds
  - Axial-radial cylindrical roller bearings ..... 146-149
  - Ball screw support bearings ..... 134-139, 192
  - Cylindrical roller bearings ..... 98-113, 193
  - Double direction angular contact thrust ball bearings ..... 120-127
  - Floating displacement bearings ..... 88-91
  - RTC bearings ..... 145-149
  - Spindle bearings ..... 16-81, 192
- Axial-radial cylindrical roller bearings ..... 141-149
  - (also see *RTC bearings 145*)
  - Nomenclature ..... 143
  - Product tables ..... 146-149
- Axial rigidity ..... (see *product tables*)
- Ball screw support bearings ..... 129-139
  - Nomenclature ..... 131, 132
  - Product tables ..... 134-139
- Basic bearing number
  - Axial-radial cylindrical roller bearings ..... 143
  - Ball screw support bearings ..... 131, 132
  - Cylindrical roller bearings ..... 95
  - Double direction angular contact thrust ball bearings ..... 117
  - Floating displacement bearings ..... 85
  - Spindle bearings ..... 10, 11, 12
- Calibration ..... 10, 196
- Ceramic hybrid bearings ..... 6, 14, 97
  - (also see *product tables*)
- Cleanliness, of lubricant ..... 158
- Clearance adjustment in cylindrical roller bearings ..... 198
- Contact angle marks ..... 10, 13
- Contamination factor V ..... 159
- Corner dimensions ..... 179
- Cronidur 30 ..... 6, 14
- Cylindrical roller bearings ..... 93-113
  - Clearance adjustment of ..... 198
  - Nomenclature ..... 95
  - Product tables ..... 98-113
- Deflection and rigidity ..... 194-195
  - Axial-radial cylindrical roller bearings, RTC ..... 195
  - Ball screw support bearings ..... 195
  - Double direction angular contact thrust ball bearings ..... 195
  - Spindle bearings ..... 194
- Dimensions ..... (see *product tables*)
- Direct lube bearings ..... 15
- DLR bearings ..... 15
  - (also see *spindle bearing product tables 16-81*)
- Double direction angular contact thrust ball bearings ..... 115-127
  - Nomenclature ..... 117
  - Product tables ..... 120-127
- Duplex sets ..... 10, 13
- Dynamic equivalent load ..... 152-153
- Endurance strength ..... 155
- Engineering ..... 150-198
- Equivalent loads with varying loads and speeds ..... 154
- Fastening holes, RTC bearings ..... 147
- Fits, speed dependent ..... 190-191
  - (see *machining tolerances for mating parts*)
- Floating displacement bearings ..... 83-91
  - Nomenclature ..... 85
  - Product tables ..... 88-91
- Friction torque ..... 134-139, 149
  - Ball screw support bearings product tables ..... 134-139
  - RTC bearings product table ..... 149
- Grease distribution run ..... 165, 198
- Grease lubrication ..... 160-165 (also see *lubrication 156*)
- Grease quantity ..... 162, 163
- Grease service life ..... 160-164
- Handling super precision bearings ..... 196
- High speed bearings ..... 11
  - (see *spindle bearing product tables*)
- Hybrid bearings, ceramic ..... 6, 14, 97
  - (also see *product tables*)
- Inner and outer spacers ..... 184
- Installation, DU set ..... 10
- ISO tolerances ..... 168-178
- Life calculation ..... 152-160
- Load ratings ..... (see *product tables*)
- Lubrication ..... 7, 119, 156-167
  - Cleanliness ..... 158
  - Contamination factor V ..... 159
  - Double direction angular contact thrust ball bearings ..... 119
  - Grease ..... 156, 160-165
  - Oil ..... 156, 166-167
  - Practices ..... 162
  - Viscosity ..... 161
  - Rated viscosity ..... 156
- Machining tolerances for mating parts ..... 180-189
  - Axial-radial cylindrical roller bearings ..... 182
  - Housing ..... 181
  - Inner and outer spacers ..... 181, 184
  - Shaft ..... 180
  - Shaft and housing fits ..... 183-189
  - Spacer sleeves ..... 181, 184
  - Tapered shafts and taper angles for cylindrical roller bearings ..... 186
- Markings on bearings ..... 10, 13
- Materials ..... 6, 14
- Minimal oil quantity lubrication ..... 166-167
- Modified life calculation ..... 155
- Mounting ..... 10, 13, 196
  - Handling precision bearings ..... 197
  - Mounting configurations ..... 10, 13
- Nomenclature
  - Axial-radial cylindrical roller bearings ..... 143
  - Ball screw support bearings ..... 131, 132
  - Cylindrical roller bearings ..... 95
  - Double direction angular contact thrust ball bearings ..... 117
  - Floating displacement bearings ..... 85
  - Spindle bearings ..... 10, 11, 12
- Oil-air lubrication ..... 166-167
- Oil Lubrication ..... 156-159, 166-167
- Preload values ..... (see *product tables*)
- Preload clamping forces ..... 197
- Preparation of parts ..... 196
- Product tables
  - Axial-radial cylindrical roller bearings ..... 146-149
  - Ball screw support bearings ..... 134-139
  - Cylindrical roller bearings ..... 98-113
  - Double direction angular contact thrust ball bearings ..... 120-127
  - Floating displacement bearings ..... 88-91
  - Spindle bearings ..... 16-81
- Quadruplex sets ..... 10, 13
- Radial clearance, cylindrical roller bearings ..... 175
- Ready to mount bearing sets ..... 13
- Rigidity ..... (see *product tables*)
- Rigidity and deflection ..... 194-195
  - Axial-radial cylindrical roller bearings, RTC ..... 6, 195
  - Ball screw support bearings ..... 195
  - Double direction angular contact thrust ball bearings ..... 195
  - Spindle bearings ..... 194
- RTC indexing bearings ..... 6, 195
  - (also see *axial-radial cylindrical roller bearings 141*)
- Sealed bearings ..... 7, 15
- Shaft and housing fits ..... 183-189
- Shaft dimensions ..... (see *product tables*)
- Shoulder dimensions ..... (see *product tables*)
- Spacers ..... 181, 184
- Speed-dependent fits ..... 190-191
- Speeds
  - Axial-radial cylindrical roller bearings ..... 146-149
  - Ball screw support bearings ..... 134-139, 192
  - Cylindrical roller bearings ..... 98-113, 193
  - Double direction angular contact thrust ball bearings ..... 120-127
  - Floating displacement bearings ..... 88-91
  - RTC bearings ..... 145
  - Spindle bearings ..... 16-81, 192
- Spindle bearings ..... 9-81
  - Nomenclature ..... 10-12
  - Product tables ..... 16-81
- Spindle head adjustments ..... 196
- Static equivalent load ..... 154
- Stress index,  $f_s$  ..... 155
- Super precision cylindrical roller bearings ..... 93-113
  - Nomenclature ..... 95
  - Product tables ..... 98-113
- Temperature limits, of bearing components ..... 155
- Test run ..... 165, 198
- Tightening torque, RTC bearings ..... 149
- Tightening torque, spindle bearings ..... 197
- Tilting rigidity, RTC bearings ..... 149
- Tolerances, by geometry ..... 10, 168-169
  - Bore diameter ..... 168
  - Outside diameter ..... 169
  - Running accuracy ..... 169
  - Width and height ..... 169
- Tolerances, by product ..... 170-178
  - Axial-radial cylindrical roller bearings ..... 178
  - Ball screw support bearings ..... 177
  - Cylindrical roller bearings ..... 172-174
  - Double direction angular contact thrust ball bearings ..... 176
  - Floating displacement bearings ..... 171
  - Spindle bearings ..... 170
- Training ..... 198
- Triplex sets ..... 13
- Turntable bearings ..... 6, 141-149, 189
- Ultra filtered grease ..... 7
- Universal bearings ..... 10, 133
- Unloading force
  - Axial-radial cylindrical roller bearings ..... 146-149
  - Ball screw support bearings ..... 134-139
  - Double direction angular contact thrust ball bearings ..... 120-127
  - Spindle bearings ..... 16-81
- Viscosity, in lubrication ..... 161
  - Rated viscosity ..... 156
- Weight ..... (see *product tables*)
- X-life Ultra bearings ..... 5, 14
- ZSB bearings ..... 16-81





# The Barden Corporation

A company of the FAG Kugelfischer Group



#### **The Barden Corporation**

P.O.Box 2449 • 200 Park Avenue  
Danbury, Connecticut 06813-2449  
Phone 203/744-2211 • Fax 203/744-3756  
E-Mail: [sales@bardenbearings.com](mailto:sales@bardenbearings.com) • [www.bardenbearings.com](http://www.bardenbearings.com)

#### **The Barden Corporation (UK)**

Plymbridge Road • Estover  
Plymouth PL6 7LH • Devon  
Phone +44(0)1752/735555 • Fax +44(0)1752/733481  
E-Mail: [sales@barden.co.uk](mailto:sales@barden.co.uk) • [www.barden.co.uk](http://www.barden.co.uk)

#### **FAG Aircraft/Super Precision Bearings GmbH**

Georg-Schäfer-Str. 30 • D-97421 Schweinfurt  
Tel +49(0)9721/911911 • Fax +49(0)9721/913666  
E-Mail: [acsp\\_gmbh@fag.de](mailto:acsp_gmbh@fag.de) • [www.fag.com](http://www.fag.com)

